

Civil Aviation Regulations 2007
[GN 133 of 2007 – 24 September 2007] [Section 11]

PART I – PRELIMINARY

1. Short title

These regulations may be cited as the Civil Aviation Regulations 2007.

2. Interpretation

(1) In these regulations –

“A Conditions” means the conditions specified in Part I of the First Schedule;

“accident” means an occurrence associated with the operation of an aircraft which takes place between the time a person boards the aircraft with the intention of flight until such time as the person has disembarked, and as a result of which –

- (a) a person is fatally or seriously injured as a result of being in or on the aircraft or by direct contact with the aircraft or anything attached thereto, except where the injury is –
 - (i) from natural causes;
 - (ii) self-inflicted or inflicted by other persons; or
 - (iii) due to hiding, as a stowaway, outside the area normally available to the passengers and crew;
- (b) the aircraft incurs damage or structural failure which adversely affects the structure, strength, performance or flight characteristics of the aircraft and which would normally require major repair or replacement of the affected component;
- (c) the safety of the operation may be affected; or
- (d) the aircraft is completely inaccessible or is missing, that is to say, the official search for it has been terminated and its wreckage has not been located;

“Act” means the Civil Aviation Act;

“advisory airspace” includes advisory area and advisory route;

“advisory area” means a designated area within a flight information region where air traffic advisory service is available;

“advisory route” means a route within a flight information region along which air traffic advisory service is available;

“aerial work” means any purpose, other than public transport, for which an aircraft is flown and where hire or reward is given or promised in respect of the flight or the purpose of the flight;

“aerial work aircraft” means an aircraft, other than a public transport aircraft, flying, or intended by the operator to fly, for the purpose of aerial work;

“aerobatic manoeuvres” means manoeuvres intentionally performed by an aircraft involving an abrupt change in its altitude, flying at an abnormal altitude, or an abnormal variation in speed;

“aerodrome control service” means air traffic control service for aerodrome traffic;

“aerodrome control tower” means a unit established to provide air traffic control service to aerodrome traffic;

“aerodrome operating minima”, in relation to the operation of an aircraft at an aerodrome, means the cloud ceiling and runway visual range for take-off, and the decision height, runway visual range and visual reference for landing, specified by the operator in, or ascertainable by reference to, the operations manual as being the minimum for the operation of that aircraft at that aerodrome;

“aerodrome traffic”, in relation to an aircraft which is in, entering or leaving, an aerodrome

traffic zone, means air traffic on the manoeuvring area, or flying in the vicinity, of an aerodrome;

“aerodrome traffic zone” means an airspace extending from the surface to a height of 2,000 feet above the level of an aerodrome and within a distance of one and a half nautical miles of its boundaries;

“aeronautical beacon” means an aeronautical ground light which is visible at all azimuth, either continuously or intermittently, to designate a particular point on the surface of the earth;

“aeronautical ground light” means any light specifically provided as an aid to air navigation, other than a light displayed on an aircraft;

“Aeronautical Information Publication” (“AIP”) means a publication issued by or with the authority of a State and containing aeronautical information of a lasting character essential to air navigation;

“aeronautical mobile radio service” means a radio service between aircraft radio stations and land stations or 2 or more aircraft radio stations;

“aeronautical station”–

(a) means a land station in the aeronautical mobile radio service; and

(b) includes a station placed on board a ship or an earth satellite;

“aeroplane” means a power driven, heavier than air, aircraft deriving its lift in flight chiefly from aerodynamic reactions on surfaces which remain fixed under a given condition of flight;

“aeroplane flight manual” means a manual, associated with a certificate of airworthiness, containing limitations within which the aeroplane is to be considered airworthy, and instructions and information necessary to the flight crew members for the safe operation of the aeroplane;

“AIC” means an Aeronautical Information Circular issued by the Authority;

“aircraft maintenance organisation” means any organisation engaged, or intending to engage, in any stage of the design, manufacture, distribution or maintenance of aircraft, aircraft components or aircraft materials, or in training activities associated therewith;

“aircraft station” means a radio station located in an aircraft;

“airline” means an air transport undertaking offering or operating scheduled air transport operations;

“air operator certificate” means a certificate authorising an operator to carry out specified commercial air transport operations;

“Airport Facilitation Programme” means the Airport Facilitation Programme referred to in regulation 136A;

“air route” means the navigable airspace between 2 points and the terrain beneath the airspace, identified to the extent necessary for the application of flight rules;

“airship” means a power driven, lighter than air, aircraft;

“air traffic” means all aircraft in flight or operating on the manoeuvring area of any aerodrome;

“air traffic advisory service” means a service provided within advisory airspace to ensure separation, insofar as is possible, between aircraft which are operating on IFR flight plans;

“air traffic control clearance” means the authorisation given to an aircraft to proceed under conditions specified by an air traffic control unit;

“air traffic control service” means a service provided for the purpose of –

(a) preventing collisions between aircraft, and between an aircraft and any obstruction on

the manoeuvring area; and

(b) expediting and maintaining an orderly flow of air traffic;

“air traffic control unit” means an area control centre, an approach control office or an aerodrome control tower;

“air traffic service” means flight information service, alerting service, air traffic advisory service or air traffic control service, area control service, approach control service or aerodrome control service;

“air traffic services reporting office” means an office established for the purpose of receiving reports concerning air traffic services and flight plans submitted before departure;

“air traffic services unit” means an air traffic control unit, a flight information centre or an air traffic services reporting office;

“air transport undertaking” means an undertaking whose business includes the carriage by air of passengers or cargo for hire or reward;

“airway” means a control area in the form of a corridor equipped with radio navigational aids;

“alerting service” means a service provided to notify organisations regarding an aircraft in need of search and rescue, and to assist any organisation where required;

“alternate aerodrome” means an aerodrome specified in the flight plan to which a flight may proceed when it becomes inadvisable to land at the aerodrome of intended landing;

“altitude” means the vertical distance of a level, a point or an object considered as a point, and measured from mean sea level;

“anti-collision light” means a flashing red light showing in all directions for the purpose of enabling the aircraft to be more readily detected by the pilot of a distant aircraft;

“approach control office” means an office established to provide air traffic control service to IFR flights arriving at, or departing from, any aerodrome;

“approach control service” means the air traffic control service for arriving or departing IFR flights;

“approach to landing” means that portion of the flight of an aircraft in which it is descending below a height of 1,000 feet above the decision height of the relevant minimum for landing;

“appropriate aeronautical radio station”, in relation to an aircraft, means an aeronautical radio station serving the area in which the aircraft is for the time being;

“appropriate air traffic control unit”, in relation to an aircraft, means the air traffic control unit notified as serving the area in which the aircraft is for the time being or intends to enter and with which the aircraft is required to communicate before entering that area;

“appropriate licence” means a licence which entitles the holder to perform the functions which he undertakes in relation to the aircraft concerned and the flight on which he is engaged;

“apron” means the part of an aerodrome provided for the stationing of aircraft for the embarkation and disembarkation of passengers or loading and unloading of cargo and for parking;

“area control service” means air traffic control service for flights in a control area;

“area navigation equipment” means equipment, carried on board an aircraft, which enables the aircraft to navigate on any desired flight path within the coverage of appropriate ground based navigation aids or within the limits of that on-board equipment or a combination of both;

“authorised” means authorised by the Authority;

“authorised person” means a person designated by the Minister to exercise any of the functions and powers conferred on the Authority;

“Authority” means the Director of Civil Aviation or such authority as may be specified in any enactment as being responsible for promoting the safety of civil aviation;

“aviation fuel” means fuel intended for use in an aircraft;

“aviation fuel installation” means any apparatus or container, including a vehicle, designed, manufactured or adapted for the storage of aviation fuel or the delivery of such fuel to an aircraft;

“B Conditions” means the conditions specified in Part II of the First Schedule;

“baggage” means the personal property of passengers or crew carried on an aircraft by agreement with the operator;

“break-in area”, in relation to an aircraft, means an area which may, for the purpose of rescue in an emergency, be most readily and effectively broken into by persons outside the aircraft;

“cabin crew”, in relation to an aircraft, means those persons on board a flight for the purpose of public transport carried for the purpose of performing, in the interests of the safety of passengers, duties assigned by the operator or commander of the aircraft, but who shall not act as a member of the flight crew;

“captive balloon” means a balloon which, when in flight, is attached by a restraining device to the surface;

“captive flight” means flight by an uncontrollable balloon during which it is attached to the surface by a restraining device;

“cargo” –

(a) means an animal or property carried on an aircraft; but

(b) does not include mail, stores or baggage;

“certificate of airworthiness” means a certificate issued under regulation 14(5) or the law of another State, together with any validation, flight manual, performance schedule or other document incorporated by reference of the certificate;

“certificate of competence” means a certificate granted to a licence holder, certifying his proficiency in respect to certain privileges, duties, or functions associated with the licence;

“certificate of maintenance review” means a certificate issued under regulation 17;

“certificate of release to service” means a certificate issued under regulation 19;

“certificate of validation” means a certificate issued under regulation 13, 14(7), 20(5) or 36;

“certificate of validity” means a certificate issued under regulation 16(5)(d);

“certificated for single pilot operation” means an aircraft which is not required to carry more than one pilot by virtue of –

(a) the certificate of airworthiness issued or rendered valid under the law of the State in which the aircraft is registered;

(b) if no certificate of airworthiness is required to be in force, the certificate of airworthiness, if any, last in force in respect of the aircraft;

(c) if no certificate of airworthiness is, or has previously been, in force but the aircraft is identical in design with an aircraft in respect of which such a certificate is, or has been, in force, the certificate of airworthiness which is, or has been, in force in respect of such an identical aircraft; or

(d) in the case of an aircraft flying in accordance with the conditions of a permit to fly issued by the Authority, that permit to fly;

“Class A airspace”, “Class B airspace”, “Class C airspace”, “Class D airspace” and “Class E airspace” mean the airspace respectively notified by the Authority as such in the Aeronautical Information Publication;

“class rating” means a rating that –

- (a) does not specify any particular make or model of aircraft; but
- (b) specifies a class of aircraft such as single engine, microlight or self launching motor glider;

“cloud ceiling” means the height above the ground of the base of the lowest layer of any cloud visible from the aerodrome, which is sufficient to obscure more than one-half of the sky so visible;

“commander”, in relation to an aircraft, means –

- (a) the member of the flight crew designated as commander of that aircraft by the operator; or
- (b) where no person has been designated under paragraph (a), the pilot in command;

“competent authority” means, in relation to –

- (a) Mauritius, the Authority;
- (b) any other State, the authority responsible under the law of that State for promoting the safety of civil aviation;

“congested area”, in relation to a city, town or settlement, means any area which is substantially used for residential, industrial, commercial or recreational purposes;

“Contracting State” means a State, other than Mauritius, which is a party to the Convention;

“control area” means an airspace which has been notified as such by the Authority and extends upwards from a notified altitude;

“controllable balloon” means a balloon, not being a balloon exceeding 2 metres in any linear dimension, which is capable of free controlled flight;

“controlled airspace” means a control area and a control zone;

“control zone” means an airspace which has been notified as such by the Authority and extends upwards from the surface;

“co-pilot” means a pilot who, in performing his duties as such, is subject to the direction of another pilot in an aircraft;

“crew” means every person employed or engaged in an aircraft in flight on the business of the aircraft;

“cross country flight” means any flight during the course of which the aircraft is more than 3 nautical miles from the aerodrome of departure;

“cruising level” means a level maintained during a significant portion of a flight;

“dangerous light” means any light which may endanger the safety of an aircraft by reason of glare or confusion with, or prevention of, clear visual reception of signals, aeronautical ground lights or beacons;

“day” means –

- (a) in relation to length of time, a continuous period of 24 hours beginning immediately after midnight UTC;
- (b) in relation to day and night, the time from half an hour before sunrise until half an hour after sunset, both times exclusive, sunset and sunrise being determined at surface level;

“decision height” means the height at which a missed approach shall be initiated if the required visual reference to continue the approach to land has not been established;

“drop” includes project or lower;

“elevation” means the vertical distance of a fixed point above mean sea level;

“emergency distance available” means the distance from the point on the surface of the aerodrome at which an aeroplane may commence its take-off to the nearest point in the direction of take-off at which the aeroplane may not roll over the surface of the aerodrome and be brought to rest, in an emergency, without risk of accident;

“FAR” means the Federal Aviation Regulations;

“final approach fix” means a fix determined by means of radio navigational aids indicating the beginning of the final approach segment;

“final approach segment” means the segment of an instrument approach procedure in which alignment and descent for landing are accomplished;

“flight crew”, in relation to an aircraft, means those members of the crew of the aircraft who undertake to act as pilot, navigator, engineer or radio operator;

“flight information centre” means a centre established to provide flight information service and alerting service;

“flight information region” means airspace of defined dimensions within which flight information service and alerting service are provided;

“flight information service” means a service provided for the purpose of giving advice and information useful for the safe and efficient conduct of flights;

“flight level” means a surface of constant atmospheric pressure which is related to a specific pressure datum and separated from such other surface by specific pressure intervals;

“flight plan” means specified information provided to an air traffic services unit relative to the intended flight of an aircraft;

“flight recorder” means a flight data recorder or a cockpit voice recorder;

“flight simulator” means an apparatus by means of which flight conditions in an aircraft are simulated on the ground;

“flight visibility” means the visibility forward from the flight deck of an aircraft in flight;

“flying display” means any flying activity deliberately performed for the purpose of providing an exhibition or entertainment at an advertised event open to the public;

“flying machine” means a heavier than air, power driven, aircraft;

“free balloon” means a balloon which, when in flight, is not attached by any form of restraining device to the surface;

“free controlled flight” means flight during which a balloon is not attached to the surface by any form of restraining device, other than a tether, not exceeding 5 metres in length, which may be used as part of the take-off procedure, and during which the height of the balloon is controllable by means of a device attached to the balloon and operated by the commander of the balloon or by remote control;

“Government aerodrome” means an aerodrome in Mauritius which is managed and operated by the Government;

“ground visibility” means the horizontal visibility at an aerodrome at ground level;

“height” means the vertical distance of a level, fixed point, or an object considered as a point, measured from a specified datum;

“helicopter” means an aircraft, heavier than air, supported in flight mainly by the reactions of the air on one or more power driven rotors on substantially vertical axes;

“hPa” means hectoPascal;

“ICAO” means the International Civil Aviation Organisation;

“Instrument Flight Rules” or “IFR” means the Instrument Flight Rules set out in Part V of the Fifteenth Schedule;

“instrument meteorological conditions” means meteorological conditions expressed in terms of visibility, cloud ceiling and distance from cloud, which are less than the minima specified for visual meteorological conditions;

“international standard” means –

- (a) an international standard or procedure adopted under Article 37 of the Convention; and
- (b) includes any subsequent amendment thereof;

“JAR” means Joint Aviation Requirements;

“JAR-FCL” means Joint Aviation Requirements for Flight Crew Licensing issued by the Joint Aviation Authorities;

“Joint Aviation Authorities” means the associated body of the European Civil Aviation Conference;

“land”, in relation to an aircraft –

- (a) means the action under normal conditions of making contact with the ground; and
- (b) includes alighting on water;

“land station” means a radio station located on the ground;

“landing area” means the part of a manoeuvring area primarily intended for landing or take-off of an aircraft;

“landing distance available” means the distance from the point on the surface of the aerodrome at which an aeroplane may commence its landing, having regard to –

- (a) the obstructions in its approach path;
- (b) the nearest point in the direction of landing at which the surface of the aerodrome is incapable of bearing the weight of the aeroplane under normal operating conditions; and
- (c) any obstacle capable of affecting the safety of the aeroplane;

“licence” –

- (a) means a licence issued under these regulations or under the law of another State; and
- (b) includes any certificate of competence or certificate of validity issued with the licence or required to be held in connection with the licence;

“licence for public use” means the licence referred to in regulation 103(4);

“licensed aerodrome” means an aerodrome licensed under regulation 103;

“licensed aerodrome operator” means the operator of an aerodrome who is licensed under the Act;

“life jacket” includes a device designed to support a person in or on water;

“log book”, in the case of an aircraft log book, an engine log book, a variable pitch propeller log book or a personal flying log book, includes a record kept in the book or by any other means approved by the Authority;

“main exit” means an exit in the side of an aircraft at floor level intended for the disembarkation of passengers in normal circumstances or in an emergency;

“manoeuvring area” –

- (a) means the part of an aerodrome provided for the take-off, landing and surface movement of an aircraft associated with take-off and landing; but
- (b) does not include the apron and any part of the aerodrome provided for the maintenance of aircraft;

“maximum total mass authorised”, in relation to an aircraft, means the maximum total mass of the aircraft and its contents at which the aircraft may take off anywhere in the world, in the

most favourable circumstances, in accordance with the certificate of airworthiness in force in respect of that aircraft;

“medical examiner” means a medical examiner registered under regulation 124A;

“microlight aeroplane” means an aeroplane, designed to carry not more than 2 persons, which has –

- (a) a maximum total mass authorised not exceeding –
 - (i) 300 kilogrammes for a single seat landplane, or 390 kilogrammes for a single seat landplane in respect of which a Mauritian permit to fly or certificate of airworthiness was in force before 1 January 2003;
 - (ii) 450 kilogrammes for a two-seat landplane;
 - (iii) 330 kilogrammes for a single seat amphibian or floatplane; or
 - (iv) 495 kilogrammes for an amphibian or two-seat floatplane; and
- (b) a wing loading at the maximum total mass authorised not exceeding 25 kilogrammes per square metre or a stalling speed at the maximum total mass authorised not exceeding 35 knots calibrated airspeed;

“minimum descent height”, in relation to the operation of an aircraft at an aerodrome, means the height in a non-precision approach below which descent may not be made without the required visual reference;

“month” means a calendar month, starting immediately after midnight UTC on the last day of the previous calendar month and ending at midnight UTC on the last day of the current calendar month;

“movement area” means the part of an aerodrome used for take-off, landing and taxiing of aircraft, consisting of the manoeuvring area and the apron;

“National Air Transport Facilitation Programme” means the programme referred to in regulation 136A;

“night” means the time from half an hour after sunset until half an hour before sunrise, sunset and sunrise being determined at surface level;

“non-precision approach” means an instrument approach using non-visual aids for guidance in azimuth or elevation which is not a precision approach;

“North Atlantic Minimum Navigation Performance Specification airspace” means the airspace specified in paragraph 18(3) of the Seventh Schedule;

“notice to airmen” or “NOTAM” means a notice containing information concerning the establishment, condition or change in any aeronautical facility, service, procedure or hazard, the timely knowledge of which is essential to personnel concerned with flight operations;

“notified” means set out by the Authority in a document published by or under an arrangement entered into with the Authority and entitled ‘NOTAM’ or ‘Mauritius AIP’ or ‘AIC’ and for the time being in force;

“operator” means a person engaged in or offering to engage in an aircraft operation;

“parascending parachute” means a parachute which is towed by cable in such a manner as to cause it to ascend;

“passenger” means a person on board an aircraft other than a member of the crew;

“performance group” means the performance group of an aircraft specified in the certificate of airworthiness in force in relation to that aircraft;

“permit to fly” means a permit issued under regulation 16(1);

“pilot in command”, in relation to an aircraft, means the person who is in charge of the piloting of the aircraft and is not under the direction of any other pilot in the aircraft;

“precision approach” means an instrument approach using Instrument Landing System, Microwave Landing System or Precision Approach Radar for guidance in both azimuth and elevation;

“pressurised aircraft” means an aircraft provided with means of maintaining, in any compartment, a pressure greater than that of the surrounding atmosphere;

“private flight” means a flight which is not for the purpose of aerial work or public transport;

“problematic use of substances” means the use of a psychoactive substance by aviation personnel in a way that –

(a) constitutes a direct hazard to the user or endangers the lives, health or welfare of others; or

(b) causes or worsens an occupational, social, mental or physical problem or disorder;

“proficiency check” has the meaning specified in –

(a) paragraph 1.001 of JAR-FCL 1, in respect of aeroplanes; and

(b) paragraph 2.001 in JAR-FCL 2, in respect of helicopters;

“prohibited area” means airspace of a defined dimension, above the land areas or territorial waters of Mauritius, within which the flight of an aircraft is prohibited;

“psychoactive substance” means alcohol, opioids, cannabinoids, sedatives, hypnotics, cocaine, other psychostimulants, hallucinogens, volatile solvents other than coffee and tobacco;

“public transport” means the carriage of persons or cargo effected by aircraft by an air transport undertaking for remuneration of any nature, or without remuneration;

“public transport aircraft” means aircraft flying, or intended by the operator to fly, for the purpose of public transport;

“qualified person” means a citizen of Mauritius or a body corporate registered in Mauritius under any enactment;

“rating” means an authorisation entered on a licence stating special conditions, privileges or limitations pertaining to the licence;

“reduced vertical separation minimum airspace” means airspace, between flight level 290 and flight level 410 inclusive, designated by the relevant competent authority as being airspace within which a vertical separation of minimum of 1,000 feet or 300 metres shall be applied;

“remotely piloted aircraft” means a remotely piloted aerial vehicle without persons on board;

“remotely piloted surveillance aircraft” means a remotely piloted aircraft which is equipped to undertake any form of surveillance or data acquisition;

“rendering valid” means the action taken by a Contracting State, as an alternative to issuing its own licence, in accepting a licence issued by any other Contracting State as the equivalent of its own licence;

“repair”, in relation to a compass, includes adjusting and compensating the compass;

“reportable occurrence” means an occurrence specified in paragraph 14 of the Seventh Schedule;

“reporting point” means a geographical location in relation to which the position of an aircraft is to be reported;

“restricted area” means airspace of defined dimensions above the land areas or territorial waters of Mauritius within which the flight of aircraft is restricted in accordance with conditions published by the Authority;

“rules of the air and air traffic control” means the rules specified in the Fifteenth Schedule;

“runway” means a defined rectangular area on an aerodrome prepared for the landing and take-off of an aircraft;

“runway visual range” means the maximum distance in the direction of take-off or landing, as the case may be, at which the runway surface markings or light delineating the runway or identifying its centre line can be seen from a point 5 metres above its centre line;

“scheduled journey” means one of a series of journeys undertaken by an aircraft for the purpose of public transport between the same 2 places and which together amount to a systematic service;

“self launching motor glider” or “SLMG” means an aircraft with the characteristics of a non-power-driven glider, fitted with one or more power units and designed or intended to take off under its own power;

“serious injury” means injury sustained by a person in an accident which –

- (a) requires hospitalisation for more than 48 hours, commencing within 7 days from the date the injury was received;
- (b) results in a fracture of bone other than a simple fracture of a finger, toe, or nose;
- (c) involves lacerations which cause severe haemorrhage or nerve, muscle or tendon damage;
- (d) involves injury to any internal organ; or
- (e) involves second or third degree burns, or any burn affecting more than 5 per cent of the body surface;

“signal area” means a selected part of an aerodrome used for the display of ground signals so as to be visible to an aircraft in the air;

“skill test”, in relation to –

- (a) an aeroplane, has the same meaning as in paragraph 1.001 of JAR-FCL1;
- (b) a helicopter, has the same meaning as in paragraph 2.001 of JAR-FCL2;

“solo flight” means a flight on which the pilot of an aircraft is not accompanied by another person holding a pilot’s licence granted or rendered valid under these regulations;

“special VFR Flight” means a flight made in –

- (a) instrument meteorological conditions or at night in a control zone or in a control zone notified for the purpose of paragraph 6 of Part III of the Fifteenth Schedule; or
- (b) any airspace in respect of which the appropriate air traffic control unit has given permission for the flight to be made in accordance with special instructions given by that unit instead of in accordance with the Instrument Flight Rules;

“State aircraft” means any aircraft of Mauritius or any other State registered as State aircraft;

“State of manufacture”, in relation to an aircraft, means the State responsible for the certification of the airworthiness of the prototype of the aircraft;

“State of registry” means the State on whose register an aircraft is entered;

“State of the operator” means the State in which an operator has his principal place of business or, if there is no such place of business, his permanent residence;

“step down fix” means a fix determined by means of radio navigation aids in the final approach segment and established for identifying a point at which a controlling obstacle has been safely overflown;

“take-off distance available” means –

- (a) the distance from the point on the surface of the aerodrome at which the aeroplane may commence its take-off run to the nearest obstacle, in the direction of take-off, projecting above the surface of the aerodrome and capable of affecting the safety of the aeroplane; or
- (b) one and one half times the take-off run available, whichever is less;

“type certificate”, in relation to an aircraft, engine or propeller, means a document issued by

the manufacturer and approved by the appropriate authority of the State of manufacture or design certifying that the type design of the aircraft, engine or propeller complies with the certification basis to which the certificate refers;

“type rating” in relation to –

- (a) an aeroplane, has the meaning specified in paragraph 1.215 of JAR-FCL 1;
- (b) a helicopter, has the meaning specified in paragraph 2.215 of JAR-FCL 2;

“UTC” means coordinated universal time;

“VFR Flight” means a flight conducted in accordance with VFR;

“Visual Flight Rules” or “VFR” means the visual flight rules set out in Part IV of the Fifteenth Schedule;

“visual meteorological conditions” means meteorological conditions expressed in terms of visibility, cloud ceiling and distance from cloud equal to or better than the specified minima.

- (2) For the purposes of these regulations, an aircraft shall be in flight in the case of –
- (a) a piloted flying machine, from the moment when, after the embarkation of its crew for the purpose of taking off, it first moves under its own power until the moment when it next comes to rest after landing;
 - (b) a pilotless flying machine or a glider, from the moment when it first moves for the purpose of taking off until the moment when it next comes to rest after landing;
 - (c) an airship, from the moment when it first becomes detached from the surface until the moment when it next becomes attached thereto or comes to rest thereon;
 - (d) a free balloon, from the moment when the balloon, including the canopy and basket, becomes separated from the surface until the moment it next comes to rest thereon;
 - (e) a captive balloon, from the moment when the balloon, including the canopy and basket, becomes separated from the surface, apart from a restraining device attaching it to the surface, until the moment when it next comes to rest thereon;
 - (f) a helicopter, from the moment the helicopter’s rotor blades start turning until the moment the helicopter finally comes to rest at the end of the flight and the rotor blades stop turning.

(3) (a) Subject to subparagraph (b), references in these regulations to the operator of an aircraft shall, for the purposes of the application of these regulations to a particular aircraft, be references to the person who, at the relevant time, has the management of that aircraft.

(b) Where, by virtue of any charter or other agreement for the hire or loan of an aircraft, a person, other than an air transport undertaking or an aerial work undertaking, has the management of that aircraft for a period not exceeding 14 days, Part IV shall apply as if the charter or other agreement had not been entered into.

[Reg. 2 amended by reg. 3 of GN 17 of 2010 w.e.f. 1 February 2010; reg. 3 of GN 139 of 2016 w.e.f. 1 July 2016.]

3. Application of regulations

- (1) Unless the context otherwise requires, these regulations shall extend to –
- (a) Mauritius;
 - (b) every aircraft registered in Mauritius and persons on such aircraft; and
 - (c) every aircraft registered in a State other than Mauritius, whilst in or flying over Mauritius, and persons on such aircraft.
- (2) These regulations, other than regulations 90 and 91, shall not apply to –
- (a) a balloon which, at any stage of its flight, is not more than 2 metres in any linear dimension, including any basket or other equipment attached to the balloon;
 - (b) a kite weighing not more than 2 kilogrammes; and
 - (c) any other aircraft weighing not more than 7 kilogrammes without fuel.

[Reg. 3 amended by reg. 4 of GN 17 of 2010 w.e.f. 1 February 2010.]

4. Exemption from regulations

(1) The Authority may exempt any aircraft or person from these regulations other than the payment of the prescribed fee.

(2) Any person who wishes to obtain an exemption under paragraph (1) shall make an application to the Authority.

(3) Where the Authority grants or rejects the application, it shall so inform the applicant in writing.

[Reg. 4 amended by reg. 5 of GN 17 of 2010 w.e.f. 1 February 2010.]

5. Variation or replacement of licence or certificate

(1) The Authority may, on application made to it by the holder of a licence or certificate, vary the licence or certificate.

(2) Where it appears to the satisfaction of the Authority that any certificate or licence issued under these regulations has been lost, destroyed or defaced, or is in a state of delapidation, the Authority may, on payment of the prescribed fee, issue a duplicate certificate or licence with the word "Duplicate" written on it.

5A. Additional fee for functions performed abroad

Where, in relation to any function in respect of which a fee is prescribed in these regulations, the Authority considers it necessary for its employee, or any other person appointed to act on its behalf, to travel outside Mauritius, the person who is required to pay the fee shall, in addition –

(a) pay to the Authority –

(i) 1,500 rupees per man/hour for the duration of the travel, to and from Mauritius, of the employee or the person appointed to act on behalf of the Authority; and

(ii) such subsistence allowance as the Authority may determine in respect of that person; and

(b) provide a return air ticket for such person.

[Reg. 5A inserted by reg. 6 of GN 17 of 2010 w.e.f. 1 February 2010.]

5B. Other fees not specified

Where the Authority performs any function relating to an aerodrome, the airworthiness of an aircraft, the operations of an aircraft, the licensing of cabin crew or flight crew and no fee is specified in these regulations for that function, the Authority may, in relation to –

(a) an aerodrome, levy a fee of 1,000 rupees per man/hour;

(b) the airworthiness of an aircraft, the operations of an aircraft or the licensing of cabin crew or flight crew, levy a fee of 6,000 rupees per man/hour.

[Reg. 5B inserted by reg. 6 of GN 17 of 2010 w.e.f. 1 February 2010.]

PART II – REGISTRATION OF AIRCRAFT

6. Registration of aircraft

(1) No person shall, subject to paragraph (2), fly an aircraft in or over Mauritius unless it is registered in –

(a) Mauritius;

(b) a Contracting State; or

(c) a State in relation to which there is in force an agreement between the Government of Mauritius and the Government of that State whereby an aircraft registered in that State is authorised to fly in or over Mauritius.

(2) Paragraph (1) shall not apply to –

(a) a glider, on a flight which –

(i) begins and ends in Mauritius without passing over any other State; and

(ii) is not for the purpose of public transport or aerial work, other than aerial work

which consists of the giving of instruction in flying or the conducting of flying tests in a glider owned or operated by a flying club, of which the person giving the instruction or conducting the test, and the person receiving the instruction or undergoing the test, are both members;

- (b) an aircraft, on a flight which –
 - (i) begins and ends in Mauritius without passing over any other State; and
 - (ii) complies with the B Conditions; or
- (c) a kite or captive balloon.

(3) Notwithstanding paragraph (2)(a), a glider shall comply with regulations 23, 26, 32 and 49.

(4) Where an aircraft flies in breach of paragraph (1) in such manner or circumstances that, if the aircraft had been registered in Mauritius, an offence against these regulations would have been committed, the same offence shall be committed in respect of that aircraft.

7. Procedure for registration of aircraft

(1) The Authority shall be responsible for the registration of an aircraft in Mauritius and for maintaining the register and shall record therein the particulars specified in paragraph (6) in a legible form, or a non-legible form where the recording is capable of being reproduced in a legible form.

(2) An application for the registration of an aircraft shall be made to the Authority and be accompanied by the following evidence –

- (a) a certificate under the hand of the Director-General of the Mauritius Revenue Authority to the effect that no customs duty or other duty, tax or charge, in respect of the aircraft, is due;
- (b) a description of the aircraft, as specified in the Third Schedule;
- (c) all particulars relating to the aircraft and its ownership; and
- (d) where the aircraft is leased, all particulars of the leasing.

(3) Subject to paragraphs (4) and (5), an aircraft shall not be registered or continue to be registered unless the Authority is satisfied that –

- (a) the aircraft has not already been registered outside Mauritius, or if it has, that such registration will cease by operation of law upon the aircraft being registered in Mauritius;
- (b) the owner, lessor, lessee, any sub-lessee or operator of the aircraft is a qualified person;
- (c) the aircraft may not more suitably be registered in another State; and
- (d) it will not be contrary to public interest for the aircraft to be, or to continue to be, registered.

(4) (a) Where any unqualified person residing or having a place of business in Mauritius, and holding a legal or beneficial interest in an aircraft, or a share therein, applies for registration of that aircraft, the Authority may, on being satisfied that the aircraft may otherwise be properly so registered, register the aircraft in the name of that person.

(b) A person referred to in subparagraph (a) shall not cause or permit the aircraft, while it is registered, to be used for the purpose of public transport or aerial work.

(5) Where an aircraft is leased to a qualified person, the Authority may, whether or not an unqualified person is entitled as owner to a legal or beneficial interest therein, register the aircraft in the name of the lessee on being satisfied that the aircraft may otherwise be properly so registered and, subject to this regulation, the aircraft may remain so registered during the subsistence of the lease.

(6) Where the Authority registers an aircraft, it shall –

- (a) enter in the register –
 - (i) the name of the registered owner;
 - (ii) the number of the certificate of registration;

- (iii) the nationality mark of the aircraft;
 - (iv) the registration mark assigned to the aircraft;
 - (v) the name of the manufacturer of the aircraft;
 - (vi) the name or the designation of the aircraft;
 - (vii) the serial number of the aircraft;
 - (viii) the name and address of any person who has an interest or a share in the aircraft;
 - (ix) where the aircraft is chartered by demise, the name of the charterer; and
 - (x) where the aircraft is registered under paragraph 4(a) or (b), an indication that it is so registered; and
- (b) issue to the registered owner a certificate of registration in the form set out in Part I of the Fourth Schedule.
- (7) Where –
- (a) there has been a change, other than a change in ownership, in the particulars furnished to the Authority in connection with the application for registration of an aircraft; or
 - (b) an aircraft has been destroyed or permanently withdrawn from use,

the registered owner of the aircraft shall, within 28 days of the change, destruction, or permanent withdrawal, as the case may be, give written notice of that fact to the Authority.

(8) On receipt of a written notice under paragraph (7), or on its own initiative, the Authority may, where it considers that it is expedient in the public interest so to do, cancel the registration of an aircraft or amend an entry in the register.

(9) (a) An application for a duplicate of a certificate of registration issued under this regulation shall be made to the Authority in such form and manner as the Authority may determine.

(b) A duplicate of a certificate of registration shall be issued on payment of the appropriate fee specified in the Second Schedule.

[Reg. 7 amended by reg. 7 of GN 17 of 2010 w.e.f. 1 February 2010.]

8. Temporary transfer of aircraft

The Minister may make such adaptation or modification to regulation 7, as he considers necessary or expedient for the purpose of providing for the temporary transfer of an aircraft to or from the register.

9. Change in ownership

- (1) Where there is a change in the ownership of an aircraft registered in Mauritius –
- (a) the registered owner of the aircraft shall forthwith give written notice of the change and surrender his certificate of registration to the Authority;
 - (b) the new owner of the aircraft shall –
 - (i) give a similar notice to the Authority; and
 - (ii) when he wishes to obtain a new certificate of registration, make an application to that effect to the Authority; and
 - (c) the aircraft shall not, except with the written permission of the Authority, be flown unless and until a new certificate of registration has been issued to the new owner.

(2) On a change in ownership of an aircraft, the new owner shall, without prejudice to any other liability on the part of the registered owner, be responsible for the payment of any charge outstanding in respect of the aircraft, whether liability for the payment of these charges was incurred before the change in ownership or not.

10. Nationality and registration marks

(1) An aircraft shall not fly in or over Mauritius unless it bears, painted on it or affixed to it, in the manner required by the law of the State in which it is registered, the nationality and registration marks required by that law.

(2) An aircraft registered in Mauritius shall bear the marks specified in the Fifth Schedule.

(3) An aircraft shall not bear any mark which purports to indicate –

(a) that the aircraft is registered in a State in which it is not so registered; or

(b) that the aircraft is a State aircraft of a particular State if it is not in fact such an aircraft,

unless the appropriate authority of that country has sanctioned the bearing of that mark.

PART III – AIR OPERATOR CERTIFICATE

11. Air operator certificate

(1) An aircraft registered in Mauritius shall not fly for the purpose of public transport unless –

(a) the operator of the aircraft is the holder of an air operator certificate; and

(b) the aircraft flies in accordance with the terms of the air operator certificate.

(2) An application for an air operator certificate shall be made to the Authority and shall contain

(a) particulars of the type of aircraft which the applicant intends to operate;

(b) the description of the flight on which the applicant intends to operate his aircraft, together with details of the purpose of the flight; and

(c) details regarding the management organisation, maintenance arrangements and operations in relation to the aircraft.

(2A) Where the number of hours required to examine an application made under paragraph (2) and relating to –

(a) an aircraft weighing not more than 2 tonnes, is more than 36 hours;

(b) an aircraft not less than 2 tonnes nor more than 15 tonnes, is more than 360 hours;

(c) an aircraft weighing more than 15 tonnes, is more than 480 hours,

the applicant shall pay an additional investigation fee of 3,000 rupees for every additional hour.

(3) Subject to paragraph (4), where the Authority is satisfied, having regard to –

(a) the applicant's previous conduct and experience;

(b) the applicant's equipment, organisation and staffing;

(c) the arrangements which the applicant proposes to make in relation to the maintenance of his aircraft, including the minimum equipment list referred to in regulation 24; and

(d) the applicant's flight crew, cabin crew and dangerous goods training programmes,

that the applicant is competent to secure the safe operation of aircraft of the types specified in the certificate on flights of the description and for the purposes so specified, it shall grant the application and issue an air operator certificate to the applicant.

(4) Every applicant shall satisfy the Authority that it has a management organisation capable of exercising operational control and supervision over any flight operated under the terms of the certificate and shall have nominated an accountable manager acceptable to the Authority to ensure that the maintenance of the operator's aircraft is carried out in accordance with the maintenance schedule approved by the Authority.

(5) An air operator certificate shall –

(a) specify the type of aircraft, which the holder of the certificate may operate;

(b) specify the description and purpose of every flight which the holder of the certificate may operate;

(c) certify that the holder of the certificate is competent to secure that an aircraft specified under subparagraph (a) is operated safely on a flight specified under subparagraph (b); and

(d) specify the period of validity.

- (6) The holder of an air operator certificate shall –
- (a) ensure that an aircraft registered in Mauritius is maintained and periodically inspected in accordance with the requirements of the maintenance schedule issued by the manufacturer and approved by the Authority, and that all airworthiness directives and mandatory service bulletins are complied with;
 - (b) ensure that an organisation approved by the Authority under regulation 22 maintains its aircraft in airworthy condition and in accordance with the approved maintenance schedule;
 - (c) establish and maintain an accident prevention and flight safety programme, the sole purpose of which shall be the prevention of accidents and which shall, in no circumstance, purport to apportion blame or liability;
 - (d) ensure that if the total mass authorised of the aircraft being flown by him for the purpose of public transport is more than 27,000 kilogrammes, a flight data monitoring programme is included as part of its accident prevention and flight safety programme.

(7) (a) Subject to subparagraphs (b) and (c), the holder of an air operator certificate shall, in respect of the number of flight hours flown by each of its aircraft pursuant to an air operator certificate in a year, pay, within one month at the expiry of every 3 months, during the whole or part of which the air operator certificate remains in force, the appropriate variable quarterly fee specified in the Second Schedule.

(b) Where the holder of an air operator certificate fails to pay the variable quarterly fee within the period of one month referred to in paragraph (a), he shall pay a surcharge of 5 per cent on every month due.

(c) This paragraph shall not apply to a non-revenue flight.

(d) For the purpose of this paragraph –

- (i) the number of flight hours shall be rounded to the nearest whole hour, with half hours being rounded up;
- (ii) a flight hour shall be calculated from the time an aircraft becomes airborne to the time the aircraft touches down, the time being in accordance with the aircraft's technical log time.

(8) Where the holder of an air operator certificate wishes that the certificate be varied by specifying a new aircraft type, he shall make an application to that effect to the Authority.

(9) Where the Authority grants an application made under paragraph (8), it shall specify the new aircraft type in the air operator certificate, subject to such terms and conditions as it may determine.

(10) Where, following the issue or renewal of an air operator certificate under this regulation, there is a change in the information furnished by the holder of the air operator certificate under paragraph (2) or (9), he shall make an application to the Authority for the variation of the air operator certificate.

(11) Where the Authority grants an application made under paragraph (10), it shall vary the air operator certificate.

[Reg. 11 amended by reg. 8 of GN 17 of 2010 w.e.f. 1 February 2010.]

12. Period of validity and renewal

(1) Subject to regulation 85, an air operator certificate shall remain in force for the period specified in the certificate.

(1A) Every person who wishes to renew his air operator certificate shall make an application to the Authority within one month of the expiry of the certificate.

(2) The Authority may renew an air operator certificate for such further period as it may determine, where it is satisfied that the holder of the certificate continues to meet the requirements of regulations 11(4) and 11(6).

(2A) Where the Authority grants an application made under paragraph (1A), it shall renew the air operator certificate.

12A. Route authorisation

(1) No person shall fly an aircraft, and no operator shall cause an aircraft to fly, on a route not located in the region specified in an air operator certificate granted under regulation 11.

(2) Where an operator intends to cause an aircraft to fly on a route not located in the region specified in its air operator certificate, it shall make an application for a variation of the certificate to the Authority.

(3) Where the Authority grants an application made under paragraph (2), it shall issue a written authorisation in respect of the new route.

[Reg. 12A inserted by reg. 10 of GN 17 of 2010 w.e.f. 1 February 2010.]

PART IV – AIRWORTHINESS AND EQUIPMENT OF AIRCRAFT

13. Type certificate

(1) The Authority shall accept or validate a type certificate in respect of any aircraft, engine or propeller that is imported into Mauritius where –

- (a) the airworthiness authority of the State of manufacture or design has issued a type certificate on the basis of FAR or JAR; and
- (b) the type certificate approval basis meets the airworthiness requirements laid down by the Authority.

(2) In any other case, the Authority may, in its discretion, accept or validate a type certificate that is issued by the airworthiness authority of the State of manufacture or design and the type certificate approval basis meets the airworthiness requirements laid down by the Authority.

14. Certificate of airworthiness

(1) Subject to paragraph (2), an aircraft shall not fly unless –

- (a) there is in force, in relation to that aircraft, a certificate of airworthiness; and
- (b) the aircraft flies in accordance with the terms of the certificate of airworthiness.

(2) Paragraph (1) shall not apply to a flight which begins and ends in Mauritius, without passing over any other State, and is made by –

- (a) a glider, which is not being used for public transport of passengers or aerial work;
- (b) a balloon, which is not being used for public transport of passengers;
- (c) a kite;
- (d) an aircraft which is flying in accordance with the A Conditions or B Conditions; or
- (e) an aircraft which is flying in accordance with a permit to fly issued by the Authority under regulation 16.

(3) In the case of an aircraft registered in Mauritius, the certificate of airworthiness referred to in paragraph (1) shall be a certificate issued or rendered valid in accordance with this regulation.

(4) The registered owner of an aircraft may apply to the Authority for a certificate of airworthiness in respect of the aircraft.

(5) Where the Authority is satisfied, having regard to –

- (a) the design, construction, workmanship and materials of –
 - (i) the aircraft, including in particular any engine fitted in the aircraft; and
 - (ii) any equipment carried in the aircraft, which it considers necessary for the airworthiness of the aircraft; and
- (b) the results of such flying trials and other tests of the aircraft as the Authority may require,

that the aircraft is fit to fly, it shall grant the application and issue a certificate of airworthiness in the form set out in Part II of the Fourth Schedule in respect of that aircraft.

(6) A certificate of airworthiness –

- (a) shall set out the category specified in the Sixth Schedule which, in the opinion of the Authority, is appropriate to the aircraft;
- (b) shall be issued subject to the condition that the aircraft shall not be flown for a purpose other than that specified in the Sixth Schedule in respect of the category to which the aircraft belongs; and
- (c) may designate, for the purpose of regulation 45(1), the performance group to which the aircraft belongs.

(6A) The registered owner of an aircraft may apply to the Authority for a variation of the category specified in a certificate of airworthiness.

(7) The Authority may issue, in respect of an aircraft registered in Mauritius, a certificate of validation rendering valid a certificate of airworthiness issued in respect of that aircraft under the law of a Contracting State.

(8) Subject to paragraph (9) and regulation 85, a certificate of airworthiness or of validation –

- (a) shall remain in force for the period specified in the certificate; and
- (b) may be renewed from time to time by the Authority for such further periods as it thinks fit, after satisfying itself that the aircraft is fit to fly.

(9) A certificate of airworthiness or of validation issued in respect of an aircraft shall cease to be in force where –

- (a) the aircraft, or such of its equipment as is necessary for the airworthiness of the aircraft, is overhauled, repaired or modified, or any part of the aircraft or of such equipment is removed or replaced, otherwise than in a manner and with material of a type other than that approved by the Authority, either generally or in relation to a class of aircraft or the particular aircraft;
- (b) the Authority has required an inspection of the aircraft or any equipment, specified in subparagraph (a), for the purpose of ascertaining the aircraft remains airworthy, until the completion of that inspection;
- (c) the Authority has required a modification of the aircraft, or any equipment, specified in subparagraph (a), for the purpose of ensuring that the aircraft remains airworthy, until the completion, to the satisfaction of the Authority, of that modification;
- (d) the aircraft has sustained damage of such a nature that, in the opinion of a person qualified under regulation 17(3), it is no longer fit to fly;
- (e) any Airworthiness Directive issued by the State of manufacture or design or any Mandatory Service Bulletin issued by the manufacturer of the aircraft is not complied with; or
- (f) an inspection required by a maintenance schedule approved by the Authority in relation to that aircraft has not been carried out, until completion of the inspection.

(10) The Authority may, for the purpose of this regulation, accept reports furnished to it by a person whom it may approve, either absolutely or subject to such conditions as it may determine, as qualified to furnish such reports.

[Reg. 14 amended by reg. 11 of GN 17 of 2010 w.e.f. 1 February 2010.]

14A. Validity and renewal of certificate of airworthiness

(1) A certificate of airworthiness shall be valid for such period as the Authority may determine and may be renewed.

(2) Notwithstanding the period for which a certificate of airworthiness is issued, the registered owner of an aircraft shall pay the appropriate fee specified in the Second Schedule, to the Authority, on an annual basis.

(3) An application for the renewal of a certificate of airworthiness shall be made to the Authority within one month of the expiry of the certificate.

(4) Where the Authority grants an application made under paragraph (3), it shall renew the certificate of airworthiness.

[Reg. 14A inserted by reg. 12 of GN 17 of 2010 w.e.f. 1 February 2010.]

14B. Certificate of airworthiness for export

(1) No person shall export an aircraft outside Mauritius unless there is a certificate of airworthiness for export in respect of that aircraft.

(2) An application for a certificate of airworthiness for export shall be made to the Authority.

(3) Where the Authority grants an application made under paragraph (2), it shall issue to the applicant a certificate of airworthiness for export.

(4) A certificate of airworthiness for export issued under paragraph (4) shall not confer on the holder of the certificate the same rights as those in respect of a certificate of airworthiness issued under regulation 14.

(5) (a) Unless specifically endorsed by the Authority, a certificate of airworthiness for export under this regulation shall not certify compliance with the airworthiness requirements of the importing State.

(b) In subparagraph (a) –

“importing State” means the State to which the aircraft is exported.

[Reg. 14B inserted by reg. 12 of GN 17 of 2010 w.e.f. 1 February 2010.]

15. Airworthiness directives, special inspections, modifications and repairs

(1) The Authority may, in the interest of safety, issue a directive that an aircraft registered in Mauritius, the aircraft engine, propeller or component shall be modified or undergo special inspection, and compliance with the directive shall be mandatory.

(2) Any airworthiness directive or its equivalent, issued by the State of manufacture and any mandatory service bulletin issued by the aircraft manufacturer shall be complied with.

(3) Every owner or operator of a Mauritius registered aircraft shall ensure that he receives all airworthiness directives and mandatory service bulletins that affect his aircraft and are issued by the Authority, the airworthiness authority in the State of manufacture or the manufacturer.

(4) (a) On the issue of an applicable airworthiness directive or mandatory service bulletin, the owner or operator of an aircraft shall –

(i) take immediate action for compliance; and

(ii) record the details of all actions taken, in the logbook, and other technical records of the aircraft.

(b) Any repair or modification shall be embodied only in accordance with approved data specified in the instructions issued by the Authority, the airworthiness authority of the State of manufacture, or the manufacturer, as the case may be.

(5) Every modification or repair carried out shall be subject to the approval of the Authority in accordance with –

(a) detailed drawings and other technical data adequate to define completely the proposed modification and using approved materials, parts and processes conforming to the manufacturer’s specifications; and

(b) the technical assessment showing compliance with an approved design standard.

(6) Every approval given by the Authority under paragraph (5) shall be subject to the payment of the appropriate fee specified in the Second Schedule.

[Reg. 15 amended by reg. 13 of GN 17 of 2010 w.e.f. 1 February 2010.]

16. Issue and renewal of permit to fly

(1) (a) Subject to subparagraph (b), the Authority shall issue, in respect of any aircraft, where a certificate of airworthiness cannot be issued for the aircraft, a permit to fly where it is satisfied that the aircraft is fit to fly having regard to the airworthiness of the aircraft and the conditions to be attached to the permit.

(b) The Authority shall not issue a permit to fly in respect of an aircraft if it appears to the Authority that the aircraft is eligible for, and ought to fly under and in accordance with, a certificate of airworthiness.

(2) (a) Subject to subparagraph (c), an aircraft flying in accordance with a permit to fly shall not fly for the purpose of public transport or aerial work, other than aerial work which consists of flights for the purpose of flying displays, associated practice, test and positioning flights or exhibition or demonstration of the aircraft.

(b) No aircraft shall carry any person during a flight for the purpose of flying displays or demonstration flying except the minimum flight crew, unless the prior permission of the Authority has been obtained.

(c) With the permission of the Authority, an aircraft flying in accordance with a permit to fly may fly for the purpose of aerial work which consists of the giving of instruction in flying or the conduct of flying tests, subject to the aircraft being owned or operated under arrangements entered into by a flying club, of which the person giving the instruction or conducting the test and the person receiving the instruction or undergoing the test are both members.

(3) An application for a permit to fly in respect of an aircraft shall be made by the operator to the Authority.

(3A) Where the Authority grants the application, it shall issue a permit to fly in relation to the airworthiness, operation or maintenance of the aircraft.

(4) Subject to paragraph (5) and regulation 85, a permit to fly issued under this regulation shall remain in force for such period as may be specified in the permit and may be renewed, from time to time, by the Authority for such further period as it may determine.

(4A) An application for the renewal of a permit to fly shall be made to the Authority, within one month of the expiry of the permit;

(4B) Where the Authority grants an application made under paragraph (4A), it shall renew the permit to fly.

(5) A permit to fly issued in respect of an aircraft shall cease to be in force –

(a) where any condition associated with the permit is not complied with;

(b) until the completion of any inspection, modification or maintenance of the aircraft or any of its equipment required for ascertaining whether the aircraft remains airworthy which is –

(i) classified as mandatory by the Authority; or

(ii) required as a condition of the permit to fly;

(c) where the aircraft, its engines or propellers, or such of its equipment as is necessary for the airworthiness of the aircraft, are modified or repaired, otherwise than where the repair or modification has been approved by the Authority or by a person approved by the Authority;

(d) unless the permit includes a current certificate of validity issued by the Authority or a person approved by the Authority.

(6) A placard shall be affixed to any aircraft flying in accordance with a permit to fly, in full view of the occupants, which shall be worded as follows –

OCCUPANT WARNING – THIS AIRCRAFT HAS NOT BEEN CERTIFICATED TO AN INTERNATIONAL REQUIREMENT

(7) An aircraft flying in accordance with a permit to fly shall be flown only by day and in accordance with the visual flight rules, unless the prior permission of the Authority has been obtained.

(8) Nothing in this regulation shall compel the Authority to accept an application for the issue, variation or renewal of a permit to fly where the application is not supported by such reports, from such approved persons, as the Authority may specify.

(9) A permission granted for the purpose of paragraph (2)(b) or (c) or (7) and an approval granted for the purpose of paragraph (5)(c) or (d) shall be in writing.

17. Certificate of maintenance review

(1) No aircraft registered in Mauritius, in respect of which a certificate of airworthiness in the transport or the aerial work category is in force, shall fly unless –

- (a) the aircraft, including its engines, together with its equipment and radio station, is maintained in accordance with a maintenance schedule approved by the Authority in relation to that aircraft;
- (b) there is in force a certificate of maintenance review issued in respect of the aircraft which certifies the date on which the maintenance review was carried out and the date when the next review is due; and
- (c) all airworthiness directives issued by the Authority, the State of manufacture or design, and all mandatory service bulletins issued by the manufacturer have been complied with.

(2) The approved maintenance schedule referred to in paragraph (1)(a) shall specify the occasions on which a review shall be carried out for the purpose of issuing a certificate of maintenance review.

(3) Subject to paragraph (4), a certificate of maintenance review shall not be issued by any person other than –

- (a) the holder of an aircraft maintenance engineer's licence which entitles him to issue that certificate;
- (b) a person whom the Authority has authorised to issue that certificate, and in accordance with that authorisation; or
- (c) a person approved by the Authority as being competent to issue that certificate, and in accordance with that approval.

(4) Where the Authority approves a maintenance schedule, it may direct that certificates of maintenance review relating to that schedule shall not be issued by any person other than the holder of such licence as the Authority may specify.

(5) A person referred to in paragraph (3) shall not issue a certificate of maintenance review unless he has first verified that –

- (a) maintenance has been carried out on the aircraft, in accordance with the maintenance schedule approved for that aircraft;
- (b) any inspection or modification required by the Authority under regulation 14 or 15 has been completed, as certified in the relevant certificate of release to service issued in accordance with regulation 19;
- (c) any defect entered in the technical log of the aircraft in accordance with regulation 18 has been rectified or its rectification has been deferred, in accordance with procedures approved by the Authority; and
- (d) a certificate of release to service has been issued, in accordance with regulation 19,

and for this purpose, the operator of the aircraft shall make such information, as is necessary, available to that person.

(6) A certificate of maintenance review shall be –

- (a) issued in 2 copies, one of which shall, during the period of validity of the certificate, be carried in the aircraft and the other be kept by the operator elsewhere than on board the aircraft; and
- (b) in a form approved by the Authority.

(7) Subject to regulation 84, every certificate of maintenance review shall be preserved by the operator of the aircraft for the period of validity of the certificate and for such further period as the Authority may require, but in any case for a minimum period of 2 years after the expiry of the period of validity.

18. Technical log

(1) A technical log shall be kept in respect of an aircraft registered in Mauritius in respect of which a certificate of airworthiness in the transport or aerial work category is in force.

(2) Subject to paragraph (3), the commander of an aircraft registered in Mauritius shall, at the end of every flight for any purpose specified in paragraph (1) –

- (a) enter in the technical log in ink or indelible pencil –
 - (i) the times when the aircraft took off and landed;
 - (ii) particulars of any defect known to him in any part of the aircraft or its equipment, being a part to which a maintenance schedule relates or, if no such defect is known to him, an entry to that effect; and
 - (iii) such other particulars in respect of the airworthiness or operation of the aircraft as the Authority may require; and
- (b) sign and date the entries.

(3) Where an aircraft is engaged on a number of consecutive flights beginning and ending on the same day and with the same person as commander of the aircraft, the commander of the aircraft may, if he is flying for the purpose of –

- (a) public transport and each of the consecutive flight begins and ends at the same aerodrome; or
- (b) dropping or projecting any material for agricultural, public health or any other similar purpose,

and, except where he becomes aware of a defect during a flight, make the entries specified in paragraph (2) in the technical log at the end of the last of the consecutive flights.

(4) On rectification of any defect which has been entered in the technical log, a person issuing a certificate of release to service, in respect of that defect, shall enter the certificate in the technical log in such a position or manner as to be readily identifiable with the entry of the defect to which it relates.

(5) The technical log referred to in paragraph (1) shall be carried in the aircraft.

(6) A copy of the certificate of release to service under paragraph (4) shall –

- (a) be kept on the ground; or
- (b) where, in the case of –
 - (i) an aeroplane, the maximum total authorised mass of which is not more than 2,730 kilogrammes; or
 - (ii) a helicopter,

it is not reasonably practicable for the copy to be kept on the ground, carried on board in a box approved by the Authority for that purpose.

(7) Subject to regulation 84, a technical log or any other approved record required to be kept under this regulation shall be preserved by the operator of the aircraft to which it relates until a date 2 years after the aircraft has been destroyed or permanently withdrawn from use, or for such shorter period as the Authority may permit in a particular case.

19. Certificate of release to service

(1) Subject to paragraphs (2), (3) and (4), an aircraft registered in Mauritius, in respect of which a certificate of airworthiness issued or rendered valid under these regulations is in force, shall not fly if a part of the aircraft or of such of its equipment as is necessary for the airworthiness of the aircraft, has been overhauled, repaired, replaced or modified, or has been inspected under regulation 14 or 15, unless there is in force a certificate of release to service relating to the overhaul, repair, replacement, modification or inspection, as the case may be.

(2) Subject to such directions as the Authority may give, a certificate of release to service shall not be required in respect of an aircraft –

- (a) the maximum total authorised mass of which is not more than 2,730 kilogrammes; and

(b) in respect of which a certificate of airworthiness of the Special Category referred to in the Sixth Schedule and granted under regulation 14 is in force.

(3) Where a repair or replacement of a part of an aircraft, or of its equipment, is carried out when the aircraft is at a place where it is not reasonably practicable for the repair or replacement to be carried out in such a manner that a certificate of release to service may be issued under this regulation, or for such a certificate to be issued while the aircraft is at that place –

(a) the aircraft may fly to a place at which such a certificate may be issued, being the nearest place –

(i) to which the aircraft may, in the opinion of the commander, safely fly by a route for which it is properly equipped; and

(ii) to which it is reasonable to fly having regard to any hazard to the liberty or health of any person on board; and

(b) the commander of the aircraft shall, within 10 days, cause written particulars of the flight, and the reasons for making it, to be given to the Authority.

(4) Where an aircraft, the maximum total authorised mass of which is not more than 2,730 kilogrammes, flies otherwise than for the purpose of public transport –

(a) no certificate of release to service is required where the only repair or replacement, in respect of which the certificate of release to service would otherwise have been required –

(i) is a repair or replacement specified in paragraph 13 of the Seventh Schedule; and

(ii) has been carried out personally by the owner or operator of the aircraft being the holder of a pilot's licence granted or rendered valid under these regulations;

(b) the owner or operator of the aircraft, shall –

(i) keep, in the aircraft log book, a record which identifies the repair or replacement;

(ii) sign and date the entry; and

(iii) subject to regulation 84, preserve the log book for a period of 2 years from the date of the last entry; and

(c) any equipment or part used in carrying out the repair or replacement shall be of a type approved by the Authority.

(5) Any equipment provided in accordance with paragraphs 1, 2, 4 and 5 of the Eighth Schedule, or any radio apparatus provided for use in an aircraft or any survival craft carried in an aircraft, whether or not that apparatus is provided in accordance with these regulations, shall not, after being overhauled, repaired or modified, be installed or placed on board for use in an aircraft registered in Mauritius, unless there is in force, in respect of the equipment or radio apparatus, at the time when it is installed or placed on board, a certificate of release to service issued in relation to the overhaul, repair or modification, as the case may be.

(6) A certificate of release to service may be issued –

(a) by the holder of an aircraft maintenance engineer's licence granted under these regulations and entitling him to issue that certificate;

(b) by the holder of a maintenance engineer's licence granted under the law of a State other than Mauritius and rendered valid under these regulations, in accordance with the privileges endorsed on the licence and subject to such conditions as the Authority may stipulate while granting the validation;

(c) in respect of an aircraft, the maximum total authorised mass of which is not more than 2,730 kilogrammes, by the holder of a licence, or authorisation of an engineer, granted or issued under the law of a Contracting State in which the overhaul, repair, replacement, modification or inspection has been carried out;

(d) by a person authorised or approved by the Authority to issue a certificate of compliance;

(e) by a person whom the Authority has authorised to issue the certificate in a particular

case, in accordance with that authorisation; or

- (f) in respect of the adjustment and compensation of direct reading magnetic compasses, by the holder of an airline transport pilot's licence or a flight navigator's licence granted or rendered valid under these regulations.
- (7) A certificate of release to service shall –
- (a) be in a form approved by the Authority;
 - (b) certify that the aircraft or its equipment has been overhauled, repaired, replaced, modified or maintained, in a manner and with material of a type approved by the Authority, and identify the overhaul, repair, replacement, modification or maintenance to which the certificate relates;
 - (c) include particulars of the work done;
 - (d) certify, in relation to any inspection required by the Authority, that the aircraft or its equipment, has been inspected in accordance with the requirements of the Authority and any consequential repair, replacement or modification has been carried out as specified in subparagraph (b); and
 - (e) subject to regulation 84, be preserved by the operator of the aircraft for the period of time for which he is required to preserve the log book relating to the same part of the aircraft or to the same equipment or apparatus.

20. Maintenance engineers

- (1) No person shall act or hold himself out as an aircraft maintenance engineer unless he –
- (a) holds an aircraft maintenance engineer's licence issued by the Authority; or
 - (b) holds a certificate issued under paragraph (5).

(1A) Every application for an aircraft maintenance engineer's licence shall be made to the Authority.

(1B) Where the Authority is satisfied that the applicant –

- (a) has passed such test as the Authority may require to establish that he has sufficient knowledge, experience, competence and skill in aeronautical engineering; and
- (b) is a fit and proper person to hold an aircraft maintenance engineer's licence,

it may issue to the applicant an aircraft maintenance engineer's licence of a category specified in the Ninth Schedule.

(2) Where, on the issue of a licence of a category specified in the Ninth Schedule, the Authority is satisfied that the applicant is qualified to issue, in respect of a particular type of aircraft or equipment the certificate specified in relation to that category, it may, subject to such terms and conditions as it may determine, include a rating specifying that type of aircraft or equipment, and the rating shall form part of the licence.

(3) A licence of a category specified in the Ninth Schedule shall, subject to any condition included in the licence, entitle the holder to issue, in respect of a type of aircraft or equipment specified in a rating included in the licence, a certificate specified in relation to that category.

(4) (a) Subject to regulation 85, a licence shall remain valid for the period specified in it and may be renewed.

(b) An application for the renewal of a licence shall be made to the Authority within one month of the expiry of the licence.

(c) Where the Authority is satisfied that the holder of a licence is a fit and proper person to hold such a licence for a further period, it shall grant the application and renew the licence, for such period as it may determine.

(4A) No person shall act or hold himself out as a maintenance engineer where he holds a licence granted under the law of another state, unless his licence has been validated by the Authority.

(4B) Every person who wishes to have his aircraft maintenance engineer's licence issued under

the law of another state rendered valid by the Authority, shall make an application to that effect to the Authority.

(5) Subject to paragraphs (9) and (10), and for such period as the Authority may specify, the Authority may issue a certificate rendering valid, a licence as an aircraft maintenance engineer granted under the law of any State other than Mauritius.

(6) On receipt of a licence issued under this regulation, the holder shall sign his name on the licence in ink, in order to make the licence valid.

(7) The holder of an aircraft maintenance engineer's licence shall not exercise the privileges of such a licence where he knows or suspects that his physical or mental condition renders him unfit to exercise such privileges.

(8) The holder of an aircraft maintenance engineer's licence shall not –

- (a) when exercising the privileges of such a licence, be under the influence of any psychoactive substance which may render him unable to safely and properly perform his duties; or
- (b) engage in any problematic use of substances.

(9) (a) For the purposes of paragraph (5), the Authority shall make the necessary comparative study for establishing the equivalence of licences issued by a Contracting State and their privileges with licences issued under these regulations and their privileges as specified in the Ninth Schedule.

(b) Where an equivalence specified in subparagraph (a) has been established, the Authority shall publish it in the form of a maintenance engineer's licensing notice or an aeronautical information circular.

(10) (a) For the purpose of –

- (i) determining whether a person is a fit and proper person to hold an aircraft maintenance engineer's licence under paragraph (1B)(b); or
- (ii) issuing a certificate under paragraph (5),

the Authority may subject the applicant to such tests, written or oral, as it may specify in writing or by way of notices.

(b) Where the applicant referred to in subparagraph (a) is required to take a test, he shall pay to the Authority the appropriate examination fee specified in the Second Schedule.

[Reg. 20 amended by reg. 15 of GN 17 of 2010 w.e.f. 1 February 2010.]

21. Approval of instructors, organisations and training courses

(1) No person shall provide a training course or instruction relating to civil aviation unless that person and the training course or instruction are approved by the Authority.

(2) Every person who wishes to provide a training course or instruction relating to civil aviation shall make an application to the Authority.

(3) Where the Authority grants an application made under paragraph (2), it shall issue a written approval in relation to the person and training course or instruction.

(4) Where the written approval issued under paragraph (3) is in relation to a training course or instruction –

- (a) the Authority shall specify the title of the training course or instruction on the written approval; and
- (b) the holder of that approval shall not provide an additional training course or instruction unless that training course or instruction has been approved by the Authority.

(5) Where the holder of the approval referred to in paragraph (4)(b) wishes to provide an additional training course or instruction, he shall make an application to the Authority for the variation of the approval.

(6) Any approval, other than an approval in relation to a training course or instruction, issued under this regulation shall be valid for a period of 12 months from the date of issue and may be renewed.

(7) An application for the renewal of an approval granted under this regulation shall be made to the Authority within one month of the expiry of the approval.

(8) Where the Authority grants an application made under paragraph (7), it shall renew the approval.

[Reg. 21 revoked and replaced by reg. 26 of GN 17 of 2010 w.e.f. 1 February 2010.]

22. Approval of maintenance organisations

(1) (a) An aircraft maintenance organisation shall not commence operations in Mauritius unless it has obtained the approval of the Authority.

(b) An aircraft maintenance organisation may make an application to the Authority for the issue, renewal or variation of a certificate of approval in respect of its activities.

(2) (a) Any aircraft maintenance organisation outside Mauritius shall not carry out maintenance, modify or repair an aircraft registered in Mauritius unless approval for the work has been given by the Authority.

(b) In granting an approval under paragraph (a), the Authority may accept, in relation to such organisation, the possession of a certificate of approval issued by the manufacturer of the aircraft, aircraft components or materials and by the competent authority of the State in which the organisation is located.

(3) The Authority shall issue a certificate of approval to an aircraft maintenance organisation which complies with its approved requirements as to facilities, resources, tools and equipment, data and documentation, and systems of quality control, adequate for the activity applied for.

(4) The aircraft maintenance organisation shall put out a maintenance organisation manual, approved by the Authority, that lays out the processes, procedures and quality systems applicable to its activities.

(5) (a) On receipt of an application made under paragraph (1)(b), the Authority may issue, renew or vary a certificate of approval.

(b) A certificate of approval shall, subject to regulation 85, remain in force for such period as may be specified therein, and may be renewed, within 2 months of the expiry of the approval, for such further period and subject to such conditions, including the issue by the authority of satisfactory audit reports, as the Authority may determine.

(c) A certificate of approval issued under this regulation may contain such limitations and particulars as may be determined by the Authority.

[Reg. 22 amended by reg. 17 of GN 17 of 2010 w.e.f. 1 February 2010.]

23. Equipment of aircraft

(1) An aircraft shall not fly unless it is equipped to –

(a) comply with the law of the State in which it is registered; and

(b) enable lights and markings to be displayed, and signals to be made, in accordance with these regulations.

(2) An aircraft registered in Mauritius shall not fly unless it is provided with such equipment as complies with the requirements of the Eighth Schedule.

(3) The equipment specified in paragraphs 1, 2, 4 and 5 of the Eighth Schedule shall be of a type approved by the Authority in relation to a class of aircraft or generally, and installed in a manner so approved.

(4) The Authority may, in any particular case, direct that an aircraft registered in Mauritius shall carry such additional or special equipment or supplies as it may specify for the purpose of facilitating –

(a) the navigation of the aircraft;

(b) the carrying out of search and rescue operations; and

(c) the survival of persons carried in the aircraft.

(5) Any equipment carried under this regulation shall be –

(a) installed or stowed;

- (b) maintained; and
- (c) adjusted,

in such manner as to be readily accessible and capable of being used by the person for whose use it is intended, and prevent injury to passengers or crew in the event of an accident or severe turbulence.

(6) The position of equipment provided for emergency use shall be indicated by clear markings in or on the aircraft.

(7) In every public transport aircraft registered in Mauritius, a notice indicating the location of life jackets, the brace position to be adopted in the event of an emergency landing, instructions on the use of safety belts, escape slides, life rafts, and oxygen masks, and location of the emergency exits and containing pictorial instructions regarding their use shall be –

- (a) exhibited in a prominent position in every passenger compartment; or
- (b) provided individually for every passenger.

(8) Every equipment carried in an aircraft shall not be installed, stowed, maintained or adjusted in such manner as to –

- (a) constitute a source of danger;
- (b) impair the airworthiness of the aircraft; or
- (c) impair the proper functioning of equipment or service necessary for the safety of the aircraft.

(9) Any navigational equipment, other than radio apparatus, capable of establishing –

- (a) the aircraft's position in relation to its position at an earlier time by computing and applying the resultant of the acceleration and gravitational forces acting upon it; and
- (b) automatically the latitude and relative bearing of selected celestial bodies,

shall, where carried in an aircraft registered in Mauritius, be of a type approved by the Authority.

(10) This regulation shall not apply to radio apparatus other than that specified in the Eighth Schedule.

24. Minimum equipment requirements

(1) The Authority may, subject to such conditions as it may determine, grant, in respect of any aircraft or class of aircraft registered in Mauritius, a permission authorising such aircraft to commence a flight in specified circumstances notwithstanding that any specified item of equipment, including radio apparatus, required by or under these regulations to be carried in the circumstances of the intended flight, is not carried or in a fit condition for use.

(2) An aircraft registered in Mauritius shall not commence a flight where any of the equipment, including radio apparatus, required by or under these regulations to be carried in the circumstances of the intended flight is not carried or in a fit condition for use unless –

- (a) it does so under and in accordance with the terms of a permission under paragraph (1) which has been granted to the operator, or a minimum equipment list derived from the manufacturer's master minimum equipment list and approved by the Authority identifying the minimum equipment and condition for an aircraft to maintain the certificate of airworthiness in force and defining operational procedures necessary to deal with inoperative equipment and prescribing maintenance procedures necessary to maintain the required level of safety and secure any inoperative equipment; and
- (b) in the case of an aircraft to which regulation 41 applies, the operations manual required thereby contains the particulars specified at paragraph 1(q) of Part I of the Thirteenth Schedule.

25. Noise certification

(1) No person shall fly an aircraft in or over Mauritius unless it complies with Annex 16 to the Convention relating to aircraft noise, engine emission and fuel venting and such other matters concerning the protection of the environment from the operation of aircraft or aircraft engines.

(2) Subject to paragraph (1), an aircraft shall not take off or land in Mauritius unless there is in force, in respect of that aircraft, a noise certificate issued by the Authority or issued or validated by the competent authority of the State in which the aircraft is registered, certifying that the aircraft complies with the applicable standards specified in Annex 16 to the Convention.

(2A) (a) Every application for a noise certificate shall be made to the Authority.

(b) Where the Authority grants an application made under subparagraph (a), it shall issue a noise certificate to the applicant.

(3) An aircraft shall not take off or land in Mauritius unless it carries a noise certificate that it is required to carry under the law of the State in which it is registered.

[Reg. 25 amended by reg. 18 of GN 17 of 2010 w.e.f. 1 February 2010.]

26. Radio equipment

(1) No aircraft shall fly unless it is equipped with a radio and radio navigation equipment to –

(a) comply with the law of the State in which the aircraft is registered; and

(b) enable communications to be made and the aircraft to be navigated in accordance with these regulations.

(2) Without prejudice to paragraph (1), an aircraft shall be equipped with radio and radio navigation equipment, in accordance with the Tenth Schedule.

(3) The Authority may direct that an aircraft registered in Mauritius shall carry such additional or special radio or radio navigation equipment as it may specify for the purpose of facilitating –

(a) the navigation of the aircraft;

(b) the carrying out of search and rescue operations; and

(c) the survival of any person carried in the aircraft.

(4) Subject to such exceptions as the Authority may specify, the radio and radio navigation equipment provided under this regulation in an aircraft registered in Mauritius shall, at all times, be maintained in a serviceable condition.

(5) Any radio and radio navigation equipment installed in an aircraft registered in Mauritius or carried on such an aircraft for use, in connection with the aircraft, whether or not in compliance with this regulation, shall be of a type approved by the Authority in relation to the purpose for which it is to be used, and, except in the case of a glider which is permitted under regulation 6 to fly unregistered, be installed in a manner approved by the Authority.

(6) Except with the approval of the Authority, no radio or radio navigation equipment specified in paragraph (5), or the manner in which such equipment is installed, shall be modified.

27. Aircraft, engine and propeller log books

(1) In addition to any other log book required under these regulations, the operator of an aircraft registered in Mauritius shall keep or cause to be kept, in respect of that aircraft –

(a) an aircraft log book;

(b) a log book in respect of every engine fitted in the aircraft; and

(c) a log book in respect of every variable pitch propeller fitted to the aircraft.

(2) A log book specified in paragraph (1) shall –

(a) contain the particulars specified in the Eleventh Schedule in relation to that log book;

(b) be of a type approved by the Authority; and

(c) contain entries and signatures in ink.

(3) An entry in a log book, other than an entry specified in paragraph 2(d)(ii) or 3(d)(ii) of the Eleventh Schedule shall –

(a) be made as soon as practicable after the occurrence to which the entry relates; and

(b) not be made more than 3 days after the expiration of the certificate of maintenance review in force, in respect of the aircraft, at the time of the occurrence.

(4) An entry specified in paragraph 2(d)(ii) or 3(d)(ii) of the Eleventh Schedule shall be made on every occasion that any maintenance, overhaul, repair, replacement, modification or inspection is undertaken on an engine or propeller.

(5) An entry in a log book may refer to any other document which shall be clearly identified and that other document shall, for the purpose of these regulations, be part of the log book.

(6) Subject to regulation 84, a log book shall be preserved by the operator of an aircraft for a period of 2 years after the aircraft, engine or variable pitch propeller, as the case may be, has been destroyed or permanently withdrawn from use.

28. Mass schedule

(1) Every flying machine or glider, in respect of which a certificate of airworthiness issued or rendered valid under these regulations is in force, shall be weighed and the position of its centre of gravity determined at such times and in such manner as the Authority may require or approve.

(2) Where an aircraft is weighed, the operator of the aircraft shall prepare a mass schedule showing –

- (a) the basic mass of the aircraft, being the mass of the aircraft empty together with the mass of unusable fuel and unusable oil in the aircraft and of such items of equipment as are indicated in the mass schedule, or such other mass as may be approved by the Authority in relation to that aircraft; and
- (b) the position of the centre of gravity of the aircraft when the aircraft contains only the items included in the basic mass, or such other position of the centre of gravity, as approved by the Authority in relation to that aircraft.

(3) Subject to regulation 84, the mass schedule shall be preserved by the operator until the next occasion on which the aircraft is weighed for the purpose of this regulation.

29. Access and inspection for airworthiness purposes

(1) The Authority may make or cause to be made any inspection, investigation, test, experiment or flight trial that it considers necessary for the purpose of these regulations.

(2) An authorised person may, at any reasonable time, inspect any document, part of an aircraft or its equipment, or material intended to be incorporated in or used in the manufacture of any part of an aircraft or its equipment and may, for that purpose, enter upon any aerodrome, aircraft, aircraft factory, maintenance facility, workshop or hangar.

(3) The owner of an aircraft, aircraft factory, maintenance facility, workshop or hangar shall, on demand, produce such records, reports and other particulars as the Authority or an authorised person may require.

PART V – AIRCRAFT CREW AND LICENSING

30. Flight crew of aircraft

(1) An aircraft shall not fly in or over Mauritius unless it carries a flight crew of the number and description required by the law of the State in which it is registered.

(2) Subject to paragraph (3), an aircraft registered in Mauritius shall carry a flight crew –

- (a) adequate in number and description to ensure the safety of the aircraft; and
- (b) of the number and description specified in –
 - (i) the certificate of airworthiness issued or rendered valid under these regulations; or
 - (ii) where no certificate of airworthiness is required under these regulations, the certificate, if any, last in force under these regulations in respect of that aircraft.

(3) A flying machine –

- (a) registered in Mauritius;
- (b) flying for the purpose of public transport; and
- (c) of a maximum total authorised mass exceeding 5,700 kilogrammes,

shall carry not less than 2 pilots as members of the flight crew.

(4) (a) Subject to subparagraph (b), an aeroplane registered in Mauritius, flying for the purpose of public transport in circumstances where the aircraft commander is required to comply with the Instrument Flight Rules, and having a maximum total authorised mass of not more than 5,700 kilogrammes and powered by –

- (i) one or more turbine jets;
- (ii) one or more turbine propeller engines and provided with a means of pressurising the personnel compartments;
- (iii) 2 or more turbine propeller engines and certificated to carry more than 9 passengers;
- (iv) 2 or more turbine propeller engines, certificated to carry fewer than 10 passengers and not provided with a means of pressurising the personnel compartments, unless it is equipped with an autopilot which has been approved by the Authority and which is serviceable on take-off; or
- (v) 2 or more piston engines, unless it is equipped with an autopilot which has been approved by the Authority and which is serviceable on take-off,

shall carry not less than 2 pilots as members of its flight crew.

(b) An aeroplane described in subparagraph (a)(iv) or (v) which is equipped with an approved autopilot shall not be required to carry 2 pilots, notwithstanding that before take-off the approved autopilot is found to be unserviceable, where the aeroplane flies in accordance with arrangements approved by the Authority.

(5) (a) Subject to subparagraph (b), a helicopter registered in Mauritius, having a maximum total authorised mass of not more than 5,700 kilogrammes and a maximum approved seating configuration of not more than 9, which is flying for the purpose of public transport in circumstances where the aircraft commander is required to comply with the Instrument Flight Rules or which is flying by night with visual ground reference, shall carry not less than 2 pilots as members of the flight crew unless it is equipped with an autopilot with, at least, altitude hold and heading mode which is serviceable on take-off.

(b) A helicopter described in subparagraph (a) which is equipped with an approved autopilot shall not be required to carry 2 pilots, notwithstanding that before take-off the approved autopilot is found to be unserviceable, where the helicopter flies in accordance with arrangements approved by the Authority.

(6) A public transport aircraft registered in Mauritius which is engaged on a flight, without landing, over a direct distance of more than 500 nautical miles, where the total distance between any 2 consecutive radio navigational fixing aids located within 20 nautical miles of the route of the proposed flight and capable of being used by the aircraft is more than 500 nautical miles, shall carry, in addition to the flight crew required to be carried by these regulations –

- (a) a flight navigator; or
- (b) navigational equipment approved by the Authority and used in accordance with any condition subject to which that approval may have been given.

(7) An aircraft registered in Mauritius which is required by regulation 26 to be equipped with radio communications apparatus shall carry a person holding a flight radiotelephony operator's licence as a member of the flight crew.

(8) The Authority may, in the interest of safety, require the operator of an aircraft registered in Mauritius to cease operating that aircraft, in circumstances that the Authority may specify, unless the aircraft carries, in addition to the flight crew required under these regulations, such additional members of the flight crew as the Authority may direct.

31. –

[Reg. 31 revoked by reg. 19 of GN 17 of 2010 w.e.f. 1 February 2010.]

32. Requirements for licensing of flight crew members

(1) A person shall not act as a member of the flight crew of an aircraft registered in Mauritius unless he is the holder of an appropriate licence granted or rendered valid under these regulations.

- (2) Notwithstanding paragraph (1), a person may, within Mauritius –
- (a) act as a flight radiotelephony operator where –
 - (i) he does so as the pilot of a glider not flying for the purpose of public transport or aerial work, or as a person being trained in an aircraft registered in Mauritius to perform duties as a member of the flight crew of an aircraft;
 - (ii) he is authorised under any enactment to operate the radiotelephony station by the holder of a licence granted in respect of that station;
 - (iii) messages are transmitted only for the purpose of instruction, or of the safety or navigation of the aircraft;
 - (iv) messages are transmitted on a frequency exceeding 60 megahertz, assigned by the Authority for use on flights on which a flight radiotelephony operator acts in one of the capacities specified in sub subparagraph (i);
 - (v) the transmitter is preset to one or more of the frequencies so assigned and cannot be adjusted in flight to any other frequency;
 - (vi) the operation of the transmitter requires the use of external switches only; and
 - (vii) the stability of the frequency radiated is maintained by the transmitter;
 - (b) subject to regulation 33(14), (15), (16) and (17), act as a pilot in command of an aircraft for the purpose of becoming qualified for the grant or renewal of a pilot's licence or inclusion or variation of any rating in a pilot's licence where –
 - (i) he is at least 17 years;
 - (ii) he is the holder of a valid medical certificate, issued by a person approved by the Authority, to the effect that he is fit so to act;
 - (iii) he complies with all the conditions subject to which that medical certificate was issued;
 - (iv) no other person is carried in the aircraft;
 - (v) the aircraft is not flying for the purpose of public transport or aerial work, other than aerial work which consists of giving instruction in flying or conducting flying tests; and
 - (vi) he so acts in accordance with instructions given by a person holding a pilot's licence, including a flying instructor's rating entitling him to give instructions in flying that type of aircraft;
 - (c) subject to regulation 33(14), (15), (16) and (17), act as pilot of an aircraft, in respect of which the flight crew required to be carried does not exceed one pilot for the purpose of becoming qualified for the grant or renewal of a pilot's licence or the inclusion or variation of any rating in a pilot's licence where –
 - (i) the aircraft is not flying for the purpose of public transport or aerial work, other than aerial work, which consists of the giving of instruction in flying or conducting flying tests;
 - (ii) he so acts in accordance with instructions given by a person holding a pilot's licence, including a flight Instructor rating, class rating instructor rating, flying instructor's rating or an assistant flying instructor's rating, entitling him to give instruction in flying the type of aircraft being flown; and
 - (iii) the aircraft is fitted with –
 - (A) dual controls and he is accompanied in the aircraft by the said instructor who is seated at the other set of controls; or
 - (B) controls designed for, and capable of use by, 2 persons and he is accompanied in the aircraft by the said instructor who is so seated as to be able to use the controls;
 - (d) subject to regulation 33(14), (15), (16) and (17), act as pilot in command of a helicopter

or gyroplane at night where –

- (i) he is the holder of an appropriate licence granted or rendered valid under these regulations in all respects save that the licence does not include an instrument rating and he has not, within the immediately preceding 13 months as pilot in command, carried out 5 take-offs and 5 landings at night;
 - (ii) he so acts in accordance with instructions given by a person holding a pilot's licence, including a flight instructor rating, flying instructor's rating or an assistant flying instructor's rating, entitling him to give instruction in flying the type of helicopter or gyroplane being flown by night, and no other person is carried; and
 - (iii) the helicopter or gyroplane is not flying for the purpose of public transport or aerial work, other than aerial work which consists of giving instruction in flying or conducting flying tests;
- (e) subject to regulation 33(14), (15), (16) and (17), act as pilot in command of a balloon where –
- (i) he is the holder of an appropriate licence granted or rendered valid under these regulations in all respects save that he has not, within the immediately preceding 13 months, carried out 5 flights each of not less than 5 minutes' duration as pilot in command;
 - (ii) he so acts in accordance with instructions given by a person authorised by the Authority to supervise flying in the type of balloon being flown, and no other person is carried; and
 - (iii) –
 - (iv) the balloon is not flying for the purpose of public transport or aerial work, other than aerial work which consists of giving of instruction in flying or conducting flying tests.

(3) No person shall act as a member of the flight crew in an aircraft registered in a State other than Mauritius unless –

- (a) in the case of an aircraft flying for the purpose of public transport or aerial work, he is the holder of an appropriate licence granted or rendered valid under the law of the State in which the aircraft is registered; or
- (b) in the case of any other aircraft –
 - (i) he is the holder of an appropriate licence granted or rendered valid under the law of the State in which the aircraft is registered; and
 - (ii) the Authority has not given any contrary direction.

(4) For the purpose of this regulation, a licence granted under the law of a Contracting State purporting to authorise the licence holder to act as a member of the flight crew of an aircraft, other than a licence purporting to authorise him to act as a student pilot only, shall, subject to such directions as the Authority may give, be a licence rendered valid under these regulations but shall not entitle the holder to act as a member of the flight crew of any aircraft flying for the purpose of public transport or aerial work or on any flight in respect of which he receives remuneration for his services as a member of the flight crew.

(5) Notwithstanding paragraph (1), a person may, unless the certificate of airworthiness in force in respect of the aircraft otherwise requires, act as pilot of an aircraft registered in Mauritius for the purpose of undergoing training or tests for the grant or renewal of a pilot's licence, where –

- (a) no other person is carried in the aircraft, or in an aircraft being towed, other than a person –
 - (i) carried as a member of the flight crew;
 - (ii) authorised by the Authority to witness the test; or
 - (iii) where the pilot in command of the aircraft is the holder of an appropriate licence,

carried for the purpose of being trained or tested as a member of the flight crew of an aircraft;

- (b) he holds a pilot's flight navigator's or engineer's licence;
- (c) the purpose of the training or test is to enable him to qualify under these regulations for the grant of a pilot's licence or for the inclusion of an additional type in the aircraft rating in his licence; and
- (d) he acts under the supervision of the holder of an appropriate licence.

(6) Paragraph (1) shall not apply to a person who acts as a member of the flight crew, other than the pilot of an aircraft registered in Mauritius, where –

- (a) he is undergoing training or tests for –
 - (i) the grant or renewal of a flight navigator's or flight engineer's licence; or
 - (ii) the inclusion, renewal or extension of a rating on the licence; and
- (b) he acts under the supervision and in the presence of the holder of the type of licence or rating for which he is undergoing the training or tests.

(7) Nothing under this regulation shall require a person to hold a licence by reason of his acting as a member of the flight crew of a glider, unless –

- (a) he acts as a flight radio operator; or
- (b) the flight is for the purpose of public transport or aerial work, other than aerial work which consists in giving instructions in flying a glider owned or operated by a flying club, of which the person giving and the person receiving instructions are both members.

(8) Notwithstanding this regulation, the holder of a licence –

- (a) shall not act as a member of the flight crew of an aircraft registered in Mauritius, in or over the territory of a Contracting State, except with the permission of the competent authority of that State, where the licence has been –
 - (i) granted or rendered valid under these regulations; and
 - (ii) endorsed to the effect that the holder does not satisfy fully the relevant international standard;
- (b) shall not act as a member of the flight crew of an aircraft in or over Mauritius, except with the permission of the Authority, whether or not the licence is or is rendered valid under these regulations, where the licence has been –
 - (i) granted or rendered valid under the law of a Contracting State; and
 - (ii) endorsed to the effect that the holder does not satisfy fully the relevant international standard.

33. Grant, renewal and effect of flight crew licences

(1) An application for a licence, of a class specified in Part I of the Twelfth Schedule, authorising the holder to act as a member of the flight crew of an aircraft registered in Mauritius shall be made in writing to the Authority.

(2) (a) On receipt of an application made under paragraph (1), the Authority may direct the applicant to undergo such medical examination, test or training course as it may consider necessary.

(b) Subject to subparagraph (c), where the Authority is satisfied that the applicant is fit to hold the licence applied for and is qualified, by reason of his knowledge, experience, competence, skill and physical and mental fitness, to act in the capacity to which the licence relates, it shall issue the licence.

(c) Where the applicant is under the minimum age specified in Part I of the Twelfth Schedule, the Authority shall reject the application.

(3) A licence granted under this regulation –

- (a) shall not be valid unless it bears the ordinary signature of the holder in ink;

- (b) shall remain in force for such period as may be indicated in the licence, but not exceeding the maximum period specified in Part I of the Twelfth Schedule; and
- (c) may be renewed by the Authority from time to time, for such further period as the Authority may determine, on being satisfied that the holder is fit to hold the licence.

(4) (a) Subject to subparagraph (b), the Authority may, on payment of the appropriate fee specified in the Second Schedule and subject to such terms and conditions as it may determine, include in a licence a rating specified in Part II of the Twelfth Schedule where it is satisfied that the applicant is qualified to act in the capacity to which the rating relates, and that rating shall form part of the licence.

(b) The Authority shall not include in a national private pilot's licence (aeroplanes) any rating other than an aircraft rating that includes one or more of a simple single engine aeroplane (NPPL) class rating, a microlight class rating or an SLMG class rating.

(5) Subject to any condition specified in the licence –

- (a) a licence shall entitle the holder to perform the functions specified, in respect of that licence, in Part I of the Twelfth Schedule; and
- (b) a rating included in the licence shall entitle the holder to perform the functions specified, in respect of that rating, in Part II of the Twelfth Schedule.

(6) Subject to paragraph (8), the holder of a pilot's licence or a flight engineer's licence –

- (a) shall not exercise the privileges of an aircraft rating contained in the licence on a flight unless the licence bears a valid certificate of test or experience appropriate to the functions which he is to perform on that flight, in accordance with Part III of the Twelfth Schedule; and
- (b) shall comply with Part III of the Twelfth Schedule.

(7) The holder of a flight navigator's licence –

- (a) shall not perform functions on a flight to which regulation 30(6) applies unless the licence bears a valid certificate of experience appropriate to the functions which he is to perform on that flight, in accordance with Part III of the Twelfth Schedule; and
- (b) shall comply with Part III of the Twelfth Schedule.

(8) Where the holder of a private pilot's licence or national private pilot's licence (aeroplanes) holds a certificate of experience or test issued under Part III of the Twelfth Schedule, he shall not exercise the privileges of an aircraft rating contained in the licence unless the certificate of test or experience required under paragraph (6) is included in the personal flying log book required to be kept by him under regulation 37.

(9) No person shall perform the functions to which an instrument rating (aeroplanes), an instrument rating (helicopters), a flying instructor's rating or an instrument meteorological conditions rating (aeroplanes) relates unless –

- (a) his licence bears a valid certificate of test appropriate to the functions to which the rating relates, in accordance with Part III of the Twelfth Schedule; and
- (b) he complies with Part III of the Twelfth Schedule.

(10) The holder of a licence granted under this regulation, other than a flight radiotelephony operator's licence, shall not perform any of the functions to which his licence relates unless the Authority has endorsed the licence with a valid medical certificate issued in relation to the holder.

(10A) The Authority shall not endorse the licence under paragraph (10) unless the holder of the licence has paid the appropriate fee specified in the Second Schedule.

(11) The holder of a licence granted under this regulation, other than a flight radiotelephony operator's licence, shall, where the Authority requires him to do so, submit himself to a medical examination by a medical examiner.

(12) Where a medical examination has been carried out under paragraph (11) –

- (a) the medical examiner shall make a report to the Authority in such form as the Authority may require; and
- (b) on the basis of that report the Authority may, subject to such terms and conditions as it may determine, issue a medical certificate to the effect that it has assessed the licence holder as fit to perform the functions to which the licence relates.

(13) A medical certificate issued under paragraph (12) shall be valid for such period as is specified in the certificate and shall form part of the licence.

(14) No person shall act as or perform the functions of a member of the flight crew of an aircraft registered in Mauritius where he knows or has reason to believe that his physical or mental condition rendered him temporarily or permanently unfit to act in that capacity or perform those functions.

(15) Where the holder of a medical certificate issued under regulation 24 or 25 –

- (a) suffers from any personal injury involving incapacity to undertake his functions as a member of the flight crew;
- (b) suffers from any illness involving incapacity to undertake these functions for a period of more than 20 days; or
- (c) in the case of a woman, has reason to believe that she is pregnant,

he or she shall give written notice of the injury, illness or pregnancy, as the case may be, to the Authority.

(16) A notice under paragraph (15) shall, in the case of –

- (a) injury or pregnancy, be given as soon as reasonably practicable;
- (b) illness, be given as soon as the period of 20 days has elapsed.

(17) A medical certificate issued under paragraph (15) shall be suspended on the occurrence of the injury or the confirmation of the pregnancy, or in the case of an illness, at the end of a period of 20 days, and –

- (a) in the case of injury or illness, the suspension shall cease on the holder being medically examined, under arrangements made by the Authority, and declared fit to resume his functions as a member of the flight crew, or the Authority exempting, subject to such terms and conditions as it may determine, the holder from a medical examination;
- (b) in the case of pregnancy, the suspension may be lifted by the Authority for such period and subject to such conditions as it thinks fit and shall cease on the holder being medically examined, under arrangements made by the Authority, after the end of the pregnancy and declared fit to resume her functions as a member of the flight crew.

(18) Nothing in these regulations shall prevent the holder of a pilot's licence from acting as pilot of an aircraft, the maximum total authorised mass of which is not more than 5,700 kilogrammes, where, with the permission of the Authority, he is testing any person for the purpose of paragraph (2), (4), (6), (7), (8) or (9), notwithstanding that the type of aircraft in which the test is conducted is not specified in the aircraft rating included in his licence or that the licence or personal flying log book, as the case may be, does not include a valid certificate of test or a valid certificate of experience in respect of the type of aircraft.

(19) - (20) –

(21) A person who, on the last occasion when he took a test for the purpose of paragraphs (6), (7), (8) and (9), failed that test, shall not be entitled to fly in the capacity for which that test would have qualified him if he had passed it.

(22) (a) Where the holder of a licence issued under this regulation wishes that his licence be varied by specifying a new rating in his licence, he shall make an application to that effect to the Authority.

(b) On receipt of an application under subparagraph (a), the Authority may direct the applicant to undergo such medical examination, test or training course as it may consider necessary.

(c) Where the Authority is satisfied that the applicant is fit to be granted the new rating and is qualified by reason of his knowledge, experience, competence, skill, and physical and mental

fitness, to act in the capacity to which the rating relates, it may grant the application.
[Reg. 33 amended by reg. 20 of GN 17 of 2010 w.e.f. 1 February 2010.]

33A. Approval of instructor, organisation, training course and examiner

(1) (a) No person shall provide any training course or instruction for the purpose of this Part unless he and the training course or instruction obtain the approval of the Authority.

(b) No person shall act as an examiner for the purpose of these regulations unless he obtains the approval of the Authority to act as such.

(2) Any person who wishes to be approved, or a training course or an instruction he intends to provide to be approved, by the Authority, shall make an application to the Authority.

(3) Any person who wishes to act as an examiner for the purpose of these regulations shall make an application to the Authority.

(4) Where the Authority grants an application made under paragraph (2) or (3), it shall issue a written approval to the applicant, subject to such conditions as the Authority may determine.

(5) An approval under this regulation, other than an approval in relation to a training course or an instruction, shall be valid for a period of 3 years from the date of issue and may be renewed.

(6) An application for the renewal of an approval shall be made to the Authority within 3 months of the expiry of the approval.

(7) Where the holder of an approval continues to satisfy any condition imposed under paragraph (4), the Authority may renew the approval.

[Reg. 33A inserted by reg. 21 of GN 17 of 2010 w.e.f. 1 February 2010.]

33B. Approved flight simulator

(1) No person shall conduct a test under these regulations in a flight simulator unless the flight simulator is approved by the Authority.

(2) Every person who wishes to conduct a test in a flight simulator shall make an application to the Authority for the approval of the flight simulator for a period not exceeding 12 months.

(3) On receipt of an application made under paragraph (2), the Authority may inspect the flight simulator.

(4) Where the Authority grants an application made under paragraph (2), it shall issue a written approval to the applicant.

(5) An approval issued under this regulation may be renewed.

(6) An application for the renewal of an approval shall be made to the Authority within one month of the expiry of the approval.

(7) Where the Authority grants an application made under paragraph (6), it shall renew the approval.

[Reg. 33B inserted by reg. 21 of GN 17 of 2010 w.e.f. 1 February 2010.]

34. Maintenance of privileges of aircraft ratings in licences

(1) The holder of –

- (a) a Private Pilot's Licence (Aeroplanes);
- (b) a Commercial Pilot's Licence (Aeroplanes);
- (c) an Airline Transport Pilot's Licence (Aeroplanes);
- (d) a Private Pilot's Licence (Helicopters),

granted under these regulations shall not be entitled to exercise the privileges of an aircraft rating contained in the licence on a flight unless –

- (i) the licence bears a valid certificate of revalidation, in respect of the rating, which is appropriate to the functions he is to perform on that flight, in accordance with Sub-part B of Part III of the Twelfth Schedule, and complies with that Part; and
- (ii) the holder has undertaken different training, in accordance with paragraph 1.235 of jar-fcl 1, in the case of an aeroplane, and paragraph 2.235 of jar-fcl 2, in the case of a helicopter, and has had particulars thereof entered in his personal flying log book, in accordance with the relevant paragraph.

(2) The holder of a flight engineer's licence shall not be entitled to exercise the privileges of an aircraft rating contained in the licence on a flight unless the licence bears a valid certificate of revalidation, in respect of the rating, and the certificate is appropriate to the functions he is to perform on the flight, in accordance with Sub-Part B of Part III of the Twelfth Schedule, and otherwise complies with that Part.

(3) The holder of –

- (a) a Private Pilot's Licence (Gyroplanes);
- (b) a Commercial Pilot's Licence (Helicopters and Gyroplanes);
- (c) an Airline Transport Pilot's Licence (Helicopters and Gyroplanes);
- (d) a Commercial Pilot's Licence (Balloons);
- (e) a Commercial Pilot's Licence (Airships);
- (f) a Commercial Pilot's Licence (Gliders),

shall not be entitled to exercise the privileges of an aircraft rating contained in the licence on a flight unless the licence bears a valid certificate of test or experience, in respect of the rating, and the certificate is appropriate to the functions he is to perform on that flight, in accordance with Sub-Part A of Part III of the Twelfth Schedule.

(4) The holder of a private pilot's licence (balloons and airships) shall be entitled to exercise the privileges of an aircraft rating contained in the licence where the licence does not bear a valid certificate of test or experience.

(5) The holder of a national private pilot's licence (aeroplanes) shall not be entitled to exercise the privileges –

- (a) of a simple single engine aeroplane (NPPL) class rating contained in the licence on a flight unless the rating is valid, in accordance with Sub-part C of Part III of the Twelfth Schedule; or
- (b) of a SLMG class rating or a Microlight class rating contained in the licence on a flight unless the licence includes a valid certificate of test or experience, in respect of the rating, and the certificate is appropriate to the functions he is to perform on that flight, in accordance with Sub-part A of Part III of the Twelfth Schedule, and otherwise complies with that Part.

(6) The holder of a flight navigator's licence shall not be entitled to perform functions on a flight to which regulation 30(6) applies unless the licence bears a valid certificate of experience which is appropriate to the functions he is required to perform on that flight, in accordance with Sub-part A of Part III of the Twelfth Schedule.

35. Maintenance of privileges of other ratings

(1) No person shall be entitled to perform the functions to which a flying instructor's rating (gyroplanes), an assistant flying instructor's rating (gyroplanes) or instrument meteorological conditions rating (aeroplanes) relates unless his licence bears a valid certificate of test which is appropriate to the functions to which the rating relates, in accordance with Sub-part A of Part III of the Twelfth Schedule, and otherwise complies with that Part.

(2) No person shall perform the functions to which an instrument rating or instructor's rating other than a flying instructor's rating (gyroplanes) relates unless his licence bears a valid certificate of revalidation appropriate to the functions to which the rating relates, in accordance with Sub-part B of Part III of the Twelfth Schedule.

(3) Every person referred to in paragraph (2) shall comply with Sub-part B of Part III of the Twelfth Schedule.

(4) For the purposes of this regulation, the rating refers to –

- (a) an instrument rating (aeroplane);
- (b) an instrument rating (helicopter);
- (c) any instructor's rating, other than a flying instructor's rating (gyroplanes) or an assistant

flying instructor's rating (gyroplanes).

[Reg. 35 amended by reg. 22 of GN 17 of 2010 w.e.f. 1 February 2010.]

36. Validation of licence

(1) (a) No person shall be a member of the flight crew of an aircraft registered in Mauritius where he holds a licence granted under the law of another State, unless his licence has been rendered valid by the Authority.

(b) Any person who wishes that his licence be rendered valid by the Authority shall make an application to the Authority.

(c) The Authority may, for such period not exceeding the period of validity of the licence or 6 months, whichever is less, as it may determine, issue a certificate of validation rendering valid, for the purpose of these regulations, the licence granted under the law of that other State.

(2) (a) Before issuing a certificate of validation, the Authority shall verify the authenticity of the licence from the issuing authority and establish its equivalence with the requirements for grant of, and the privileges attached to, the corresponding Mauritian licence.

(b) Where the Authority is unable to grant the certificate of validation, it shall inform the applicant of any additional requirements or tests that are necessary for the grant of the certificate of validation.

(3) For the purpose of paragraph (1), the Authority may subject the applicant to such tests, written or oral, as the Authority may specify in writing or by way of notice.

[Reg. 36 amended by reg. 23 of GN 17 of 2010 w.e.f. 1 February 2010.]

36A. Certificate of authenticity

(1) Any person who holds a licence may make an application to the Authority for a certificate of authenticity confirming the authenticity of the licence.

(2) Where the Authority grants the application, it shall issue a certificate of authenticity confirming the authenticity of the licence.

[Reg. 36A inserted by reg. 24 of GN 17 of 2010 w.e.f. 1 February 2010.]

37. Personal flying log book

Every member of the flight crew of an aircraft registered in Mauritius, and every person who engages in flying for the purpose of qualifying for the grant or renewal of a licence, shall keep a personal flying log book in which –

- (a) the name and address of the holder of the log book;
- (b) particulars of the holder's licence to act as a member of the flight crew;
- (c) the name and address of his employer;
- (d) particulars of every flight made as a member of the flight crew of an aircraft, or while flying for the purpose of qualifying for the grant or renewal of a licence, as the case may be, including –
 - (i) the date, duration and places of arrival and departure of every flight;
 - (ii) the type and registration mark of the aircraft;
 - (iii) the capacity in which the holder acted in flight;
 - (iv) particulars of any special condition under which the flight was conducted, including night flying and instrument flying; and
 - (v) particulars of any test or examination undertaken whilst in flight; and
- (e) particulars of any test or examination undertaken while in a flight simulator, including –
 - (i) the date of the test or examination;
 - (ii) the type of simulator;
 - (iii) the capacity in which the holder acted; and
 - (iv) the nature of the test or examination,

shall be recorded.

38. Instruction in flying

- (1) A person shall not give instruction in flying unless he holds a licence which –
 - (a) entitles him to give the instruction, and to act as pilot in command of the aircraft, for the purpose and in the circumstances under which the instruction is to be given; and
 - (b) includes an appropriate instructor's rating, in accordance with Part II of the Twelfth Schedule, entitling him to give the instruction.
- (2) Paragraph (1) –
 - (a) shall apply to instruction in flying given to a person flying, or about to fly, a flying machine or glider for the purpose of becoming qualified for –
 - (i) the grant of a pilot's licence; or
 - (ii) the inclusion or variation of any rating in his licence;
 - (b) shall not apply to instruction in flying given to a person to enable that person to become qualified for the inclusion in his licence of an aircraft rating entitling him to act as pilot of a multi-engined aircraft, or an aircraft of a class specified in the Third Schedule, where that person has, under these regulations, previously been entitled or qualified to act as pilot of a multi-engined aircraft, or of an aircraft of that class, as the case may be.

39. Flight operations officer

A person shall not act as a flight operations officer, for the purpose of regulation 44(1) and (4), unless he has been approved by the Authority on the basis of his training, qualifications and experience, as determined from time to time by the Authority, in accordance with Annex 6 to the Convention.

40. Glider pilot minimum age

A person under the age of 16 years shall not act as pilot in command of a glider.

40A. Cabin crew

(1) No person shall be a cabin crew member on an aircraft registered in Mauritius unless he holds a crew member certificate issued by the Authority under paragraph (4).

(2) Where the holder of an air operator certificate issued in relation to public transport wishes to employ a person as a cabin crew member, the holder of the air operator certificate shall make an application to the Authority for the issue of a crew member certificate to that person.

(3) On receipt of an application made under paragraph (2), the Authority may direct the holder of the air operator certificate to furnish the names of the person he wishes to employ as a cabin crew member.

(4) Where the Authority grants the application, it shall issue to the holder of the air operator certificate, a cabin crew certificate, subject to such terms and conditions as the Authority may determine.

- (5) A cabin crew certificate issued under paragraph (4) shall –
 - (a) include the names of the –
 - (i) person to be employed as cabin crew member; and
 - (ii) holder of the air operator certificate; and
 - (b) include such particulars as the Authority may consider necessary.

(6) Subject to paragraph (12), a cabin crew certificate shall be valid for a period of 12 months from the date of issue and may be renewed.

(7) An application for the renewal of a cabin crew certificate shall be made within one month of the expiry of the certificate.

- (8) Where the person named in the cabin crew certificate –
 - (a) is still employed by the holder of the air operator certificate;

- (b) is still a fit and proper person to hold the cabin crew certificate; and
- (c) continues to satisfy any term and condition imposed under paragraph (4),

the Authority may renew the cabin crew certificate.

(9) A cabin crew certificate issued or renewed under this regulation shall lapse where –

- (a) the person named in the cabin crew certificate –
 - (i) is no longer a fit and proper person to hold the certificate; or
 - (ii) is no longer employed by the holder of the air operator certificate; or
- (b) the applicant referred to in paragraph (2) no longer holds a valid air operator certificate.

(10) Where a cabin crew certificate is lost, defaced or rendered illegible, the Authority may, on payment of the appropriate fee specified in the Second Schedule, issue a duplicate certificate.

(11) Where a cabin crew certificate which has been lost is subsequently found, the holder of the cabin crew certificate shall forthwith –

- (a) inform the Authority that the lost cabin crew certificate has been found; and
- (b) surrender any duplicate cabin crew certificate issued to the Authority.

(12) Any person who –

- (a) knowingly retains a duplicate cabin crew certificate in contravention of paragraph (11); or
- (b) without reasonable excuse, has in his possession an original cabin crew certificate and its duplicate at the same time,

shall commit an offence.

[Reg. 40A inserted by reg. 25 of GN 17 of 2010 w.e.f. 1 February 2010.]

40B. Cabin crew on board aircraft

(1) An aircraft registered in Mauritius carrying passengers on a flight for the purpose of public transport shall –

- (a) where it carries not less than 20 passengers, or where, in accordance with its certificate of airworthiness, it may carry more than 35 passengers and at least one passenger is carried, carry not less than one cabin crew member for every 50, or fraction of 50, passenger seats installed in the aircraft, unless the Authority has granted written permission to the operator to carry a lesser number on that flight and the operator carries the number specified in that permission and complies with any other term and condition subject to which such permission is granted; or
- (b) where it has more than 200 passenger seats installed, carry a number of cabin crew members, which shall not be less than the number of main exits in the aircraft.

(2) A cabin crew member shall perform, in the interest of the safety of passengers, such duties as may be assigned to him by the operator or the person in command of the aircraft.

[Reg. 40B inserted by reg. 25 of GN 17 of 2010 w.e.f. 1 February 2010.]

PART VI – OPERATION OF AIRCRAFT

41. Operations manual

(1) This regulation shall apply to public transport aircraft registered in Mauritius, other than an aircraft used solely for flights not intended to exceed 60 minutes in duration and which are flights –

- (a) solely for training persons to perform duties in an aircraft; or
- (b) intended to begin and end at the same aerodrome.

(2) The operator of an aircraft shall –

- (a) make available to every member of his operating staff an operations manual;
- (b) ensure that every copy of the operations manual is kept up to date; and
- (c) ensure that on each flight every member of the crew has access to a copy of every part

of the operations manual which is relevant to his duties on the flight.

- (3) An operations manual –
- (a) shall contain –
 - (i) at least the information required by Annex 6 of the Convention, as applicable to the type of aircraft;
 - (ii) information and instructions relating to the matters specified in Part I of the Thirteenth Schedule; and
 - (iii) such other information and instructions as may be necessary, and acceptable to the Authority, to enable the operating staff to perform their assigned duties;
 - (b) shall not be required to contain information or instructions available in a flight manual accessible to the persons by whom the information or instructions may be required.

(4) An aircraft shall not fly unless, not less than 30 days before the flight, the operator of the aircraft has furnished to the Authority a copy of the whole of the operations manual, for the time being in force in respect of the aircraft, and has obtained the approval for the operations manual.

(5) Subject to paragraph (6), the operator shall notify the Authority of any amendment made to the operations manual before the amendment comes into operation.

(6) Where an amendment of the operations manual, including any addition, relates to an aspect of the operation of an aircraft to which the operations manual did not previously relate, that aircraft shall not fly for the purpose of public transport until the Authority has been notified of the amendment, and the approval for the amended operations manual has been granted.

(7) The operator shall make any amendment to the operations manual that the Authority may require for the purpose of ensuring the safety –

- (a) of the aircraft, or persons or property carried in the aircraft; or
- (b) efficiency or regularity of air navigation.

(8) Where, in the course of a flight on which any equipment required under scale O in paragraph 5 of the Eighth Schedule becomes unserviceable, the aircraft shall, for the remainder of that flight, be operated in accordance with any relevant instruction in the operations manual.

(9) In this regulation –
“operating staff” –

- (a) means the servants and agents employed by the operator, whether or not as members of the crew of the aircraft, to ensure that the flights of the aircraft are conducted in a safe manner; and
- (b) includes an operator who himself performs all or some of the functions specified in this regulation.

42. Training manual

(1) The operator of an aircraft registered in Mauritius and flying for the purpose of public transport shall –

- (a) make a training manual available to every person appointed by the operator to give or supervise the training, experience, practice or periodical tests required under regulation 43(3); and
- (b) ensure that every copy of that training manual is kept up to date.

(2) A training manual shall contain all necessary information and instructions relating to the matters specified in Part III of the Thirteenth Schedule and such other information and instructions as may be necessary to enable a person, appointed by the operator to give or supervise the training, experience, practice and periodical tests required under regulation 43(3), to perform his duties.

(3) No aircraft shall fly unless, not less than 30 days before the flight, the operator of the aircraft has furnished to the Authority a copy of the whole of his training manual relating to the crew of that aircraft and has obtained the approval for the training manual.

(4) Subject to paragraph (5), the operator shall notify the Authority of any amendment made to the training manual before or immediately after the amendment comes into operation.

(5) Where an amendment of the training manual, including any addition, in respect of an aircraft relates to an aspect of training, experience, practice or periodical tests to which the training manual did not previously relate, that aircraft shall not fly for the purpose of public transport until the Authority has been notified of the amendment, and the approval for the amended training manual has been granted.

(6) The operator shall make any amendment to the training manual that the Authority may require for the purpose of ensuring the safety of the aircraft, or persons or property carried in the aircraft, or the safety, efficiency or regularity of air navigation.

(7) An application for the approval of a training manual, or amendment thereof, shall be accompanied by the appropriate fee specified in the Second Schedule.

[Reg. 42 amended by reg. 26 of GN 17 of 2010 w.e.f. 1 February 2010.]

43. Responsibilities of public transport operator

(1) Subject to paragraph (2), the operator of an aircraft registered in Mauritius shall not permit the aircraft to fly for the purpose of public transport unless he has –

- (a) designated from among the flight crew a pilot to be the commander of the aircraft for the flight;
- (b) satisfied himself that the aeronautical radio stations and navigational aids serving the intended route or any planned diversion from that route are adequate for the safe navigation of the aircraft;
- (c) satisfied himself that the aerodrome at which it is intended to take off or land and any alternate aerodrome are suitable for the purpose and are adequately manned and equipped, including such manning and equipment as are set out in paragraph 12(2) of Part I of the Seventh Schedule, to ensure the safety of the aircraft and its passengers; and
- (d) established an accident prevention and flight safety programme.

(2) The operator of an aircraft to which this regulation applies shall not be required to satisfy himself as to the adequacy of fire fighting, search, rescue or other services which are required only after the occurrence of an accident.

(3) The operator of an aircraft registered in Mauritius –

- (a) shall not authorise any person to be a member of the crew of the aircraft during any flight for the purpose of public transport, other than a flight for the sole purpose of training persons to perform duties in an aircraft, unless –
 - (i) that person has had the training, experience, practice and periodical tests, specified in Part II of the Thirteenth Schedule in respect of the duties which he is to perform; and
 - (ii) the operator has satisfied himself that the person is competent to perform his duties and to use the equipment provided in the aircraft for that purpose;
- (b) shall maintain, preserve and, on demand, produce or furnish to the Authority, information relating to any matter specified in subparagraph (a), in accordance with Part II of the Thirteenth Schedule.

(4) The operator of an aircraft registered in Mauritius shall not permit any member of the flight crew of the aircraft, during any flight for the purpose of the public transport of passengers, to simulate emergency manoeuvres and procedures which the operator has reason to believe will adversely affect the flight characteristics of the aircraft.

(5) No aircraft shall be refueled when passengers are embarking or disembarking the aircraft unless it is properly attended by qualified personnel ready to initiate and direct an evacuation of the aircraft by the most practical and expeditious means available.

44. Loading of public transport aircraft

(1) The operator of an aircraft registered in Mauritius shall not, in relation to a flight for the

purpose of public transport, cause any load to be suspended from the aircraft or cause or permit the aircraft to be loaded, except under the supervision of a person who is a flight operations officer or a pilot holding a commercial pilot's licence or a higher category of licence, and has been furnished with written instructions as to the distribution and securing of the load to ensure that –

- (a) the load may safely be carried on the flight; and
- (b) any condition relating to the loading of the aircraft, subject to which the certificate of airworthiness in force in respect of the aircraft was issued or rendered valid, is complied with.

(2) Subject to paragraph (6), the instructions referred to in paragraph (1) shall specify –

- (a) the mass of the aircraft prepared for service, being the aggregate of the mass of the aircraft shown in the mass schedule referred to in regulation 28 and the mass of any additional item in or on the aircraft that the operator thinks fit to include;
- (b) any additional item referred to in subparagraph (a); and
- (c) the position of the centre of gravity of the aircraft at the mass indicated under subparagraph (a).

(3) Where an aircraft has been loaded in contravention of paragraph (1), an authorised person may require the aircraft to be unloaded.

(4) Subject to paragraphs (5) and (6), the person supervising the loading of an aircraft under paragraph (1) shall, before the commencement of a flight, prepare and sign a load sheet in duplicate, in accordance with paragraph 2 of Part I of the Seventh Schedule, and shall, unless he is himself the commander of the aircraft, submit the load sheet for examination by the commander who shall sign his name on the load sheet.

(5) Paragraph (4) shall not apply where the load and the manner in which it is distributed and secured upon the next intended flight are to be unchanged from the previous flight and the commander of the aircraft makes and signs an endorsement to that effect on the load sheet for the previous flight, indicating the date of the endorsement, place of departure and destination upon the next intended flight.

(6) Paragraphs (2) and (4) shall not apply where –

- (a) the maximum total authorised mass of the aircraft is not more than 1,150 kilogrammes;
- (b) the maximum total authorised mass of the aircraft is not more than 2,730 kilogrammes and the flight is intended not to exceed 60 minutes in duration and is a flight –
 - (i) solely for training persons to perform duties in an aircraft; or
 - (ii) intended to begin and end at the same aerodrome; or
- (c) the aircraft is a helicopter of a maximum total authorised mass which is not more than 3,000 kilogrammes and the total seating capacity of which is not more than 5 persons.

(7) Subject to paragraph (8), and regulation 81, the original of the load sheet shall be carried in the aircraft until the flight to which it relates has been completed and a copy of the load sheet, together with a copy of the instructions referred to in paragraph (1), shall be preserved by the operator for a period of 6 months and shall not be carried in the aircraft.

(8) Where, in the case of –

- (a) an aeroplane of a maximum total authorised mass which is not more than 2,730 kilogrammes; or
- (b) a helicopter,

it is not reasonably practicable for the copy of the load sheet to be kept on the ground, it may be carried on board in a box approved by the Authority for that purpose.

(9) The operator of an aircraft registered in Mauritius and flying for the purpose of public transport of passengers shall not cause or permit baggage to be carried in the passenger compartment of the aircraft unless such baggage may be properly secured and, in the case of an aircraft capable of seating more than 30 passengers, such baggage shall not exceed the capacity of the space, in the

passenger compartment, approved by the Authority for the purpose of stowing baggage.

45. Public transport (operating conditions)

(1) An aircraft registered in Mauritius shall not fly for the purpose of public transport, except for the sole purpose of training persons to perform duties in an aircraft, unless the requirements specified in Part I of the Seventh Schedule in respect of its mass and related performance are complied with.

(2) The assessment of the ability of an aircraft to comply with paragraph (1) shall be based –

- (a) on the information as to its performance contained in the certificate of airworthiness relating to the aircraft; or
- (b) where the information given in the certificate of airworthiness is not sufficient for the purpose, on the best information available to the commander of the aircraft.

(3) Subject to paragraphs (4), (5) and (6), a flying machine registered in Mauritius, when flying over water for the purpose of public transport, shall, except as may be necessary for the purpose of take-off or landing, fly at such an altitude as will enable it –

- (a) if it has one engine only, in the event of the failure of that engine; or
- (b) if it has more than one engine, in the event of the failure of one of those engines and with the remaining engine or engines operating within the maximum continuous power conditions specified in the certificate of airworthiness relating to the flying machine,

to reach a place at which it may safely land at a height sufficient to enable it to do so.

(4) An aeroplane, in respect of which a certificate of airworthiness is in force, designating the aeroplane as being of performance Group X, shall not fly over water for the purpose of public transport so as to be more than 90 minutes' flying time from the nearest shore, unless the aeroplane has more than 2 power units or is approved for extended range twin engine operations (ETOPs) by the Authority, in accordance with Chapter 4 of Annex 6 Part I to the Convention, or such other requirements issued from time to time by ICAO.

(5) A helicopter, in respect of which a certificate of airworthiness is in force, designating the helicopter as being of performance Group B, shall not fly over water –

- (a) for the purpose of public transport so as to be more than 20 seconds' flying time from a point from which it may make an autorotative descent to land suitably for an emergency landing unless it is equipped with an apparatus, approved by the Authority, enabling it to land safely on water;
- (b) on any flight for more than 3 minutes except with the permission, in writing, of the Authority and in accordance with any condition subject to which that permission may have been given.

(6) A helicopter, in respect of which a certificate of airworthiness is in force, designating the helicopter as being of performance Group A2, shall not fly over water for the purpose of public transport for more than 15 minutes unless it is equipped with an apparatus, approved by the Authority, enabling it to land safely on water.

(7) In this regulation, flying time shall be calculated –

- (a) for the purpose of paragraph (4), at normal cruising speed with one power unit inoperative; and
- (b) for the purpose of paragraph (5), on the assumption that the helicopter is flying in still air at the speed specified in the certificate of airworthiness, in force in respect of the helicopter, as the speed for compliance with regulations governing flights over water.

(8) For the purpose of paragraphs (5) and (6) –

'Group A' means a helicopter with more than one power unit with performance such that, in the event of the failure of one power unit, it is possible either to continue the flight or to land back on the take-off area and a Group A helicopter having engineering standards such that the probability of an emergency landing may be considered as –

- (a) remote, shall be classified as Group A1;

(b) reasonably probable, shall be classified as Group A2;

'Group B' means a helicopter with performance such that, in the event of the failure of one power unit at any point en-route, a landing has to be made.

46. Aerodrome operating minima for aircraft registered in Mauritius

(1) This regulation shall apply to aircraft to which regulation 41 applies.

(2) Subject to paragraph (3), the operator of an aircraft shall include, in the operations manual relating to the aircraft –

(a) the particulars of aerodrome operating minima established by the operator that are appropriate to every aerodrome of intended departure or landing and every alternate aerodrome; and

(b) the data and instructions that will enable the commander of the aircraft to calculate aerodrome operating minima appropriate to any aerodrome the use of which could not have reasonably been foreseen by the operator before the commencement of the flight.

(3) Where, in relation to any flight, it is not practicable to include the particulars referred to in paragraph (2)(a) in the operations manual, the operator of the aircraft shall –

(a) before the commencement of the flight furnish, in writing, to the commander of the aircraft, particulars of the aerodrome operating minima appropriate to every aerodrome of intended departure or landing and to every alternate aerodrome and calculated in accordance with the specified method; and

(b) keep a copy of the particulars under subparagraph (a) otherwise than on board the aircraft for a minimum period of 3 months.

(4) The aerodrome operating minima specified under this regulation shall not, in respect of an aerodrome, in any State, be less favourable than the operating minima declared in respect of that aerodrome by the competent authority of that State, unless that authority otherwise permits in writing.

(5) In establishing aerodrome operating minima under this regulation, the operator of an aircraft shall –

(a) take into account –

(i) the type, performance and handling characteristics of the aircraft and any relevant condition in its certificate of airworthiness;

(ii) the composition of the crew of the aircraft;

(iii) the physical characteristics of the relevant aerodrome and its surroundings;

(iv) the dimensions of the runways which may be selected for use;

(v) whether any visual or other aids to assist aircraft in approach, landing or take-off, being aids which the crew of the aircraft are trained and equipped to use, are in use at the aerodrome;

(vi) the procedure for approach, landing and take-off which may be adopted according to whether any aid under sub subparagraph (v) is in use;

(b) establish, in relation to every runway which may be selected for use, an aerodrome operating minima appropriate to every set of circumstances which may reasonably be expected.

(6) An aircraft shall not commence a flight at a time when –

(a) the cloud ceiling or runway visual range at the aerodrome of departure is less than the relevant minimum specified for take-off; or

(b) according to the information available to the commander of the aircraft, there is a likelihood that it would not be able, without flying in breach of paragraph (7), to commence or continue an approach to landing at the aerodrome of intended destination at the estimated time of arrival there or at any alternate aerodrome at a time at which, according to a reasonable estimate, the aircraft would arrive there.

(7) An aircraft shall not –

- (a) commence or continue an approach to landing at an aerodrome where the runway visual range at that aerodrome is, at that time, less than the specified minimum for landing, except that an approach to landing may be continued if, when the commander of the aircraft receives information that the runway visual range is less than the specified minimum for landing –
 - (i) the aircraft is below the specified decision height;
 - (ii) the specified visual reference has been established at the decision height and is maintained; and
 - (iii) the approach to landing has, at least until the specified visual reference has been established, been made by use of an instrument landing system notified for the purpose of these regulations;
- (b) continue an approach to landing at any aerodrome by flying below the specified decision height unless from that height the specified visual reference for landing is established and maintained; or
- (c) conduct a Category II, Category IIIA, Category IIIB or Category IIIC approach and landing, or take-off, otherwise than under, and in accordance with, the terms of a written approval granted by the Authority.

(8) A written approval granted under paragraph (7)(c) may be subject to such conditions as the Authority may determine.

(9) An aircraft shall not descend below the height specified at a final approach fix or step down fix unless the aircraft has overflowed the said fix.

(10) Where, according to the information available, an aircraft would be required by the Rules of the air and air traffic control to be flown in accordance with the Instrument Flight Rules at the aerodrome of intended landing, the commander of the aircraft shall select, before take-off, an alternate aerodrome unless no aerodrome suitable for that purpose is available.

(11) In this regulation –

“Category II approach and landing” means a landing following a precision approach using an Instrument Landing System or Microwave Landing System with –

- (a) a decision height below 200 feet but not less than 100 feet; and
- (b) a runway visual range of not less than 300 metres;

“Category IIIA approach and landing” means a landing following a precision approach using an Instrument Landing System or Microwave Landing System with –

- (a) a decision height lower than 100 feet; and
- (b) a runway visual range of not less than 200 metres;

“Category IIIB approach and landing” means a landing following a precision approach using an Instrument Landing System or Microwave Landing System with –

- (a) a decision height lower than 50 feet or no decision height; and
- (b) a runway visual range less than 200 metres but not less than 75 metres;

“Category IIIC approach and landing” means a landing following a precision approach using an Instrument Landing System or Microwave Landing System with no decision height and no runway visual range limitations;

“specified”, in relation to an aircraft, means specified by the operator in the aerodrome operating minima included in the operations manual or made available to the flight crew pursuant to paragraph (2).

47. Aerodrome operating minima for aircraft not registered in Mauritius

(1) This regulation shall apply to public transport aircraft registered in a State other than Mauritius.

- (2) An aircraft shall not fly in or over Mauritius unless the operator of the aircraft has –
- (a) furnished to the Authority such particulars, as the Authority may require, relating to the aerodrome operating minima specified by the operator in relation to aerodromes in Mauritius for the purpose of limiting the use of the aerodromes by the aircraft for take-off or landing, including any instruction given by the operator in relation to those aerodrome operating minima; and
 - (b) made such amendments or additions to the specified aerodrome operating minima and has given such instructions, as the Authority may require, for the purpose of ensuring the safety, efficiency or regularity of air navigation.

(3) An aircraft shall not begin or end a flight at an aerodrome in Mauritius in contravention of the aerodrome operating minima specified in relation to that aerodrome or of the instructions referred to in paragraph (2).

(4) Without prejudice to paragraph (3), an aircraft shall not –

- (a) commence or continue an approach to landing at an aerodrome in Mauritius where the runway visual range at the aerodrome is, at that time, less than the specified minimum for landing, except that an approach to landing may be continued where, when the commander of the aircraft receives information that the runway visual range is less than the specified minimum for landing –
 - (i) the aircraft is below the specified decision height;
 - (ii) the specified visual reference has been established at the decision height and is maintained; and
 - (iii) the approach to landing has, at least until the specified visual reference has been established, been made by use of an instrument landing system notified for the purpose of these regulations; or
- (b) continue an approach to landing at any aerodrome in Mauritius by flying below the specified decision height unless from that height the specified visual reference is established and maintained.

(5) An aircraft shall not descend below the height prescribed at a final approach fix or a step down fix unless the aircraft has overflown the said fix.

(6) (a) An aircraft shall not, where the relevant runway visual range is less than 150 metres, conduct a Category II, Category IIIA, Category IIIB or Category IIIC approach and landing or take off otherwise than under, and in accordance with, the terms of an approval granted by the Authority.

(b) An approval granted pursuant to subparagraph (a) shall be in writing and may be granted subject to such conditions as the Authority may determine.

(7) In this regulation –

“Category II”, “Category IIIA”, Category IIIB”, “Category IIIC”, and “specified”, in relation to an aircraft, have the same meaning as in regulation 46(11).

48. Aerodrome operating minima for non-public transport aircraft

(1) This regulation shall apply to an aircraft which is not a public transport aircraft.

(2) An aircraft shall not, where the relevant runway visual range is less than 150 metres, conduct a Category II, Category IIIA or Category IIIB approach and landing or take-off otherwise than under, and in accordance with, the terms of an approval to do so granted in accordance with the law of the State in which it is registered.

(3) In the case of an aircraft registered in Mauritius, an approval referred to in paragraph (2) shall –

- (a) be issued by the Authority in writing; and
- (b) be subject to such conditions as the Authority may determine.

(4) Without prejudice to paragraph (2), an aircraft shall not, when making a descent at an aerodrome to a runway in respect of which there is a notified instrument approach procedure, descend

from a height of 1,000 feet or more above the aerodrome to a height less than 1,000 feet above the aerodrome where the relevant runway visual range for that runway is, at that time, less than the specified minimum for landing.

(5) Without prejudice to paragraph (4), an aircraft shall not, when making a descent to a runway in respect of which there is a notified instrument approach procedure –

- (a) continue an approach to landing on such a runway by flying below the relevant specified descent height; or
- (b) descend below the relevant specified minimum descent height,

unless, in either case, from such height, the specified visual reference for landing is established and maintained.

(6) Where, according to the information available, an aircraft is, as regards any flight, required by the Rules of the air to be flown in accordance with the Instrument Flight Rules at the aerodrome of intended landing, the commander of the aircraft shall, before take-off, select an alternate aerodrome unless no aerodrome suitable for that purpose is available.

(7) In this regulation –

“Category II”, “Category IIIA”, “Category IIIB” and “Category IIIC” have, in relation to an approach and landing, the same meaning as in regulation 46 (11);

“specified”, in relation to aerodrome operating minima, means such particulars of aerodrome operating minima as have been notified in respect of the aerodrome or, if the relevant minima have not been notified, such minima as are ascertainable by reference to the notified method for calculating aerodrome operating minima.

49. Pre-flight action by commander of aircraft

The commander of an aircraft registered in Mauritius shall, before the aircraft takes off, satisfy himself that –

- (a) having regard to the latest information available as to the route and aerodromes to be used, the weather reports and forecasts available, and any alternative course of action which may be adopted in case the flight cannot be completed as planned, the flight may safely be made;
- (b) the radio apparatus and any other equipment, required under these regulations in the circumstances of the intended flight, is carried and is in a fit condition for use;
- (c) the aircraft is fit for the intended flight;
- (d) any certificate of maintenance review required under regulation 17(1) is in force and shall remain in force during the intended flight;
- (e) the load to be carried by the aircraft is of such mass and so distributed and secured that it may safely be carried on the intended flight;
- (f) in the case of a flying machine or airship, sufficient fuel, oil and engine coolant, if required, is carried for the intended flight and a safe margin has been allowed for contingencies and, in the case of a flight for the purpose of public transport, the instructions in the operations manual relating to fuel, oil and engine coolant have been complied with;
- (g) in the case of an airship or balloon, sufficient ballast is carried for the intended flight;
- (h) in the case of a flying machine, having regard to the performance of the flying machine in the conditions to be expected on the intended flight and to any obstructions at the places of departure and intended destination and on the intended route, it is capable of safely taking off, reaching and maintaining a safe height and making a safe landing at the place of intended destination; and
- (i) any pre-flight check system established by the operator, and set out in the operations manual or elsewhere, has been complied with by every crew member of the aircraft.

50. Pilot to remain at controls

(1) The commander of a flying machine or glider registered in Mauritius shall cause one pilot to remain at the controls at all times while the aircraft is in flight.

(2) Where a flying machine or glider registered in Mauritius is required under these regulations to carry 2 pilots, the commander shall cause both pilots to remain at the controls during take-off and landing.

(3) Where a flying machine or glider registered in Mauritius carries 2 or more pilots, whether or not it is required to do so, and is engaged on a flight for the purpose of the public transport of passengers, the commander shall remain at the controls during take-off and landing.

(4) Every pilot at the controls of a flying machine or glider shall be secured in his seat by a safety belt, with or without one diagonal shoulder strap or a safety harness, except that, during take-off and landing, a safety harness shall be worn if it is required under regulation 23 and the Eighth Schedule.

51. Duties of commander of public transport of passengers

(1) This regulation shall apply to a flight made for the purpose of public transport of passengers by an aircraft registered in Mauritius.

(2) The commander of an aircraft shall –

- (a) subject to paragraph (3), before the aircraft takes off, take all reasonable steps to ensure that every passenger is made familiar with the position and method of use of emergency exits, safety belts, harnesses, oxygen equipment, life jackets and all other devices required under these regulations and intended for use by passengers individually in case of an emergency;
- (b) where the aircraft is not a seaplane and is intended, in the course of the flight, to reach a point more than 30 minutes' flying time from the nearest land, take all reasonable steps to ensure that, before that point is reached, every passenger is given a practical demonstration of the method of use of the life jackets required under these regulations for the use of passengers;
- (c) where the aircraft is a seaplane, take all reasonable steps to ensure that, before the aircraft takes off, every passenger is given a practical demonstration of the method of use of the equipment referred to in subparagraph (b);
- (d) before the aircraft takes off or lands, take all reasonable steps to ensure that the members of the crew of the aircraft are properly secured in their seats and any person carried under regulation 31(1) is properly secured in a seat so situated in a passenger compartment that he may readily assist passengers;
- (e) before the aircraft takes off or lands or where, by reason of turbulent air or any emergency occurring during a flight, he considers it necessary, take all reasonable steps to ensure that –
 - (i) every passenger is properly secured in his seat by a safety belt or a safety harness; and
 - (ii) those items of baggage in the passenger compartment which he reasonably considers ought, by virtue of their size, weight or nature, to be properly secured, are properly secured and, in the case of an aircraft capable of seating more than 30 passengers, such baggage is stowed in the passenger compartment stowage spaces approved by the Authority for the purpose, or is carried in accordance with the terms of a written permission granted by the Authority, which permission may be granted subject to such conditions as the Authority may determine;
- (f) in an emergency, take all reasonable steps to ensure that every passenger is instructed in the emergency action which he should take;
- (g) except where a pressure greater than 700 *hectopascal* is maintained in all passenger and crew compartments throughout the flight, take all reasonable steps to ensure that –
 - (i) before the aircraft reaches flight level 130, the method of use of oxygen provided in the aircraft, in compliance with the requirements of regulation 23 and the Seventh Schedule, is demonstrated to every passenger;
 - (ii) on reaching flight level 130, every passenger is recommended to use oxygen;

- (iii) oxygen is used by the crew of the aircraft where the aircraft is flying above flight level 130, or during any continuous period exceeding 30 minutes where the aircraft is flying above flight level 100 but not above flight level 130.

(3) The requirement specified in paragraph (2)(a) in respect of life jackets may, except in the case of a seaplane, be complied with at any time before the aircraft reaches a point beyond gliding distance from land.

(4) In this regulation, flying time shall be calculated on the assumption that the aircraft is flying in still air at the speed specified in the certificate of airworthiness, in force in respect of the aircraft, as the speed for compliance with regulations governing flights over water.

52. Operation of radio in aircraft

(1) The radio station in an aircraft shall not be operated, whether or not the aircraft is in flight, except in accordance with the conditions of a licence issued in respect of that station, under the law of the State in which the aircraft is registered, and by a person duly licensed, or otherwise permitted to operate the radio, under that law.

(2) Subject to paragraph (3), where an aircraft is in flight in such circumstances that it is required under these regulations to be equipped with a radio communication apparatus, a continuous radio watch shall be maintained by a member of the flight crew listening to the signals transmitted on the frequency notified, or designated by a message received from an appropriate aeronautical radio station, for use by that aircraft.

(3) The radio watch under paragraph (2) may –

- (a) where a message under paragraph (2) so permits, be discontinued or continued on another frequency; and
- (b) be kept by a device installed in the aircraft where –
 - (i) the appropriate aeronautical radio station has been informed to that effect and has raised no objection; and
 - (ii) that station is notified or, in the case of a station situated in a State other than Mauritius, otherwise designated to transmit a signal suitable for that purpose.

(4) Subject to paragraph (5), no person shall make an emission from a radio station in an aircraft other than –

- (a) an emission of the class and frequency for the time being in use, in accordance with general international aeronautical practice, in the airspace in which the aircraft is flying;
- (b) a distress, urgency or safety message or signal, in accordance with general international aeronautical practice;
- (c) a message or signal relating to the flight of the aircraft, in accordance with general international aeronautical practice; or
- (d) a public correspondence message permitted under the aircraft radio station licence referred to in paragraph (1).

(5) The radio station in an aircraft shall not be operated so as to cause interference which impairs the efficiency of aeronautical telecommunications or navigational services.

(6) Subject to paragraph (7), where an aircraft registered in Mauritius is equipped with a radio communication apparatus, a telecommunications log book shall be kept in which shall be recorded –

- (a) the identification of the aircraft station;
- (b) the date and time of the beginning and of every radio watch maintained in the aircraft and the frequency of a distress signal or distress message;
- (c) the date and time and particulars of any message or signal sent or received;
- (d) particulars of any action taken upon the receipt of a distress signal or distress message; and
- (e) particulars, and the cause, of any failure or interruption of radio communications.

(7) A telecommunications log book shall not be required to be kept in respect of communications by radiotelephony with a radio station on land or on a ship which provides a radio service for aircraft.

(8) The flight radio operator maintaining radio watch shall sign the entries in the telecommunications log book indicating the times at which he began and ended the maintenance of his watch.

(9) Subject to regulation 84, the telecommunications log book shall be preserved by the operator of the aircraft for a period of 6 months after the date of the last entry.

(10) In any flying machine registered in Mauritius which is engaged on a flight for the purpose of public transport, the pilot and the flight engineer, if any, shall not make use of a hand-held microphone, whether for the purpose of radio communication or of intercommunication within the aircraft, while the aircraft is flying in controlled airspace below flight level 150 or is taking off or landing.

53. Minimum navigation performance

(1) This regulation shall apply to an aircraft registered in Mauritius which is engaged on a flight specified in regulation 30(6).

(2) A person shall not fly an aircraft or an operator shall not cause an aircraft to fly unless –

- (a) it is equipped with navigation systems, required under paragraph 18(1) of Part I of the Seventh Schedule, to enable the aircraft to maintain the prescribed navigation performance capability for the airspace through which it is flying;
- (b) the navigation systems required under subparagraph (a) have been approved by the Authority and installed and maintained in a manner approved by the Authority;
- (c) the operating procedures for the navigation systems required under subparagraph (a) have been approved by the Authority; and
- (d) the equipment is operated in accordance with the approved procedures while the aircraft is in flight.

(3) Where an operator intends to cause an aircraft to fly, it shall make an application to the Authority for the approval of the navigation systems, required under paragraph (2)(a), and the operating procedures of the navigation systems.

(4) Where the Authority grants the application, it shall issue a written approval in respect of the navigation systems and their operating procedures.

[Reg. 53 amended by reg. 27 of GN 17 of 2010 w.e.f. 1 February 2010.]

54. Height keeping performance of aircraft registered in Mauritius

(1) Unless otherwise authorised by the appropriate air traffic control unit, an aircraft registered in Mauritius shall not fly in reduced vertical separation minimum airspace, notified for the purpose of this regulation, unless it is equipped with height keeping systems, required under paragraph 18(2) of Part I of the Seventh Schedule, capable of being operated to enable the aircraft to maintain the prescribed height keeping performance and the systems are so operated.

(2) The equipment required under paragraph (1) shall –

- (a) be approved, installed and maintained in a manner approved by the Authority; and
- (b) while the aircraft is flying in the said airspace, be operated in accordance with procedures approved by the Authority.

(2A) Every operator of an aircraft registered in Mauritius shall make an application to the Authority for the approval of the height keeping systems referred to in paragraph (1).

(3) Where the Authority grants the application, it shall issue a written approval in respect of the height keeping systems referred to in paragraph (1).

[Reg. 54 amended by reg. 28 of GN 17 of 2010 w.e.f. 1 February 2010.]

55. Height keeping performance of aircraft registered elsewhere than in Mauritius

Unless otherwise authorised by the appropriate air traffic control unit, an aircraft registered elsewhere than in Mauritius shall not fly in Mauritius in reduced vertical separation minimum airspace, notified for the purpose of this regulation, unless –

- (a) it is so equipped with height keeping systems as to comply with the law of the State in which it is registered insofar as that law requires it to be so equipped when flying in any specified area; and
- (b) the equipment is capable of being operated so as to enable the aircraft to maintain the height keeping performance prescribed in respect of the airspace in which the aircraft is flying, and it is so operated.

56. Area navigation equipment of aircraft registered in Mauritius

- (1) No aircraft registered in Mauritius shall fly in any controlled airspace unless –
 - (a) it is equipped with area navigation equipment which is –
 - (i) approved by the Authority in relation to the purpose for which it is to be used; and
 - (ii) installed and maintained in a manner approved by the Authority; and
 - (b) the equipment is capable of being operated to enable the aircraft to maintain the navigation accuracy, notified in respect of the airspace in which the aircraft is flying, and it is so operated.
- (2) An approval referred to in paragraph (1) –
 - (a) shall be in writing and may be subject to such conditions as the Authority may determine; and
 - (b) may be granted in respect of any aircraft, or specified class or category of aircraft, or a specified type or types of equipment.

57. Area navigation equipment of aircraft registered elsewhere than in Mauritius

- (1) No aircraft registered elsewhere than in Mauritius shall fly in any controlled airspace unless –
 - (a) it is so equipped with area navigation equipment to comply with the law of the State in which the aircraft is registered insofar as that law requires it to be equipped when flying within any specified area; and
 - (b) the equipment is capable of being operated to enable the aircraft to maintain the navigation accuracy, notified in respect of the airspace in which the aircraft is flying, and it is so operated.
- (2) No aircraft registered elsewhere than in the Mauritius shall, when flying in any controlled airspace, be navigated by means of area navigation equipment unless –
 - (a) the equipment complies with the law of the State in which the aircraft is registered insofar as that law requires it to be so equipped when flying within any specified area; and
 - (b) the equipment is capable of being operated to enable the aircraft to maintain the navigation accuracy, notified in respect of the airspace in which the aircraft is flying, and it is so operated.

58. Use of airborne collision avoidance system

On any flight on which an airborne collision avoidance system is required by the Tenth Schedule to be carried on board, the system shall be operated in the case of an aircraft –

- (a) to which regulation 41 applies, in accordance with procedures specified in the operations manual for the aircraft;
- (b) registered in Mauritius and to which regulation 41 does not apply, in accordance with procedures which are suitable, having regard to the purposes of the equipment;
- (c) registered elsewhere than in Mauritius, in accordance with any procedure with which it is required to comply under the law of the State in which the aircraft is registered.

59. Flight recorders and records

(1) A flight data recorder or a cockpit voice recorder required under paragraphs 4 and 5 of the Eighth Schedule to be carried in an aeroplane shall be in use, at all times, from the beginning of the take-off run to the end of the landing run.

- (2) Subject to regulation 84, the operator of an aeroplane shall –
 - (a) at all times preserve –
 - (i) the last 25 hours of recording made by any flight data recorder required under these regulations to be carried in the aeroplane; and
 - (ii) the recording of not less than one representative flight which was made within the preceding 12 months and includes a take-off, climb, cruise, descent, approach to landing and landing, together with a means of identifying the recording with the flight to which it relates; and
 - (b) where required to do so by the Authority, preserve for such period as the Authority may determine, any recording specified in subparagraph (a).

60. Towing of gliders

(1) No aircraft in flight shall tow a glider unless the certificate of airworthiness issued or rendered valid in respect of the towing aircraft, under the law of the State in which that aircraft is registered, expressly provides that it may be used for that purpose.

(2) The length of the combination of towing aircraft, tow rope and glider in flight shall not exceed 150 metres.

(3) The commander of an aircraft which is about to tow a glider shall, before the towing aircraft takes off, satisfy himself that –

- (a) the tow rope is in good condition and is of adequate strength for the purpose and the combination of towing aircraft and glider is capable of flying in the manner specified in regulation 49(h);
- (b) signals have been agreed upon between, and communication established with, persons suitably stationed to enable the glider to take off safely;
- (c) emergency signals have been agreed upon between the commander of the towing aircraft and the commander of the glider, to be used –
 - (i) by the commander of the towing aircraft, to indicate that the tow should immediately be released by the glider;
 - (ii) by the commander of the glider, to indicate that the towing cannot be released.

(4) The glider shall, before the aircraft takes off, be attached to the towing aircraft by means of the tow rope.

61. Towing, picking up and raising of persons and articles

(1) No aircraft in flight shall, by means external to the aircraft, tow any article, other than a glider, or pick up or raise any person, animal or article, unless the certificate of airworthiness issued or rendered valid expressly provides that it may be used for that purpose.

(2) No aircraft in flight shall tow any article, other than a glider, at night or when the flight visibility is less than one nautical mile.

(3) The length of the combination of towing aircraft, tow rope and article in tow shall not exceed 150 metres.

(4) A helicopter shall not fly at any height over a congested part of a city, town or settlement at any time when a person, animal, or article is suspended from the helicopter.

(5) A passenger shall not be carried in a helicopter at any time when a person, animal or article is suspended from it, unless that passenger has duties to perform in connection with the person, animal or article.

(6) Nothing under this regulation shall –

- (a) prohibit the towing, in a reasonable manner, by an aircraft in flight of any radio aerial instrument which is being used for experimental purposes, or signal apparatus or other article required or permitted under these regulations to be towed or displayed by an aircraft in flight;

- (b) prohibit the picking up or raising of any person, animal or article in an emergency or for the purpose of saving life;
- (c) apply to any aircraft while it is flying, in accordance with Part II of the First Schedule;
- (d) be construed to permit the towing or picking up of a glider otherwise than in accordance with regulation 60.

62. Dropping of persons, animals and articles

(1) No animal or article, whether or not attached to a parachute, shall be dropped or permitted to drop from an aircraft in flight so as to endanger persons or property.

(2) Except with the permission in writing of the Authority, and subject to paragraphs (3), (4) and to regulation 63, no person, animal or article, whether or not attached to a parachute, shall be dropped or permitted to be dropped to the surface from an aircraft flying over Mauritius.

(3) Paragraph (2) shall not apply –

- (a) to the descent of any person by parachute from an aircraft in an emergency;
- (b) where, by or with the authority of the commander of an aircraft –
 - (i) an article is dropped for the purpose of saving life;
 - (ii) fuel or any other article in the aircraft is jettisoned in an emergency;
 - (iii) ballast in the form of fine sand or water is dropped;
 - (iv) any article is dropped solely for the purpose of navigating the aircraft, in accordance with ordinary practice or these regulations;
 - (v) a rope, banner, or similar article towed by aircraft is dropped at any aerodrome, in accordance with these regulations; or
 - (vi) an article is dropped for the purpose of public health or as a measure against weather conditions, surface icing or oil pollution or for training in the dropping of articles for these purposes, where the article is dropped with the permission of the Authority and in accordance with any condition subject to which that permission may have been given.

(4) Nothing in this regulation shall prohibit the lowering of any person, animal or article from a helicopter to the surface where the certificate of airworthiness issued or rendered valid in respect of the helicopter expressly provides that it may be used for that purpose.

63. Aerial application certificate

(1) No person shall use an aircraft to –

- (a) drop an article for the purpose of agriculture, horticulture or forestry;
- (b) train a person in the dropping of an article for any of the purposes referred to in subparagraph (a); or
- (c) drop a person or an animal,

unless he is the holder of an aerial application certificate issued under this regulation.

(2) An application for an aerial application certificate shall be –

- (a) made in writing to the Authority; and
- (b) accompanied by an aerial application manual containing such information and instruction as may be necessary to enable the operating staff to perform their duties under the certificate.

(3) Where the Authority is satisfied, having regard to –

- (a) the applicant's previous conduct and experience;
- (b) the applicant's equipment, organisation and staffing; and
- (c) the arrangements which the applicant proposes to make in relation to the maintenance of his aircraft,

that the applicant is a fit and competent person to secure the safe operation of the aircraft, it shall issue to the applicant an aerial application certificate.

(4) An aerial application certificate shall remain in force for the period specified in the certificate and may be renewed by the Authority, for such period as it may determine, on being satisfied that the holder is a fit person for holding such a certificate.

(4A) An application for the renewal of an aerial application certificate shall be made to the Authority within one month of the expiry of the certificate;

(4B) Where the Authority continues to be satisfied of the requirements in paragraph (3), it may grant an application made under paragraph (4A) and renew the aerial application certificate for such period as it may determine.

(5) The holder of an aerial application certificate shall –

(a) make available to every member of his operating staff a copy of the manual referred to in paragraph (2); and

(b) make any amendment or addition to the manual that the Authority may require.

[Reg. 63 amended by reg. 29 of GN 17 of 2010 w.e.f. 1 February 2010.]

64. Carriage of weapons and munition of war

(1) Subject to paragraph (4), no operator shall carry any munition of war on board an aircraft unless –

(a) it is carried with the written approval of the Authority and in accordance with any condition relating thereto; and

(b) the commander of the aircraft is informed, in writing, by the operator, before the flight commences, of the type, weight or quantity and location of any such munition of war on board or suspended beneath the aircraft and any condition to the approval of the Authority.

(1A) Where any munition of war is intended to be carried on an aircraft, the operator shall make an application to the Authority.

(1B) Where the Authority grants an application made under paragraph (1A), it shall issue a written approval to the operator.

(2) Notwithstanding paragraph (1), it shall be an offence for –

(a) an aircraft to carry any munition of war in any compartment or apparatus to which passengers have access; or

(b) any person on board an aircraft to carry any munition of war on his person or in his hand baggage.

(3) It shall be an offence for a person to carry, have in his possession or take or cause to be taken on board an aircraft, to suspend or cause to be suspended beneath an aircraft or to deliver or cause to be delivered for carriage thereon, any sporting weapon unless –

(a) the sporting weapon –

(i) is part of the baggage of a passenger on the aircraft or consigned as cargo to be carried thereby;

(ii) is carried in a part of the aircraft, or in any apparatus attached to the aircraft, inaccessible to passengers; and

(iii) in the case of a firearm, is unloaded;

(b) particulars of the sporting weapon have been furnished by that passenger or by the consignor to the operator before the flight commences; and

(c) the operator consents to the carriage of such sporting weapon on the aircraft and has obtained the written approval of the Authority.

(3A) Where any sporting weapon is intended to be carried on an aircraft, the operator shall make an application to the Authority.

(3B) Where the Authority grants an application made under paragraph (3A), it shall issue a written approval to the operator.

(4) Nothing in this regulation shall apply to any sporting weapon or munition of war taken or carried on board an aircraft registered in a State other than Mauritius where the sporting weapon or munition of war may, under the law of the State in which the aircraft is registered, be lawfully taken or carried on board for the purpose of ensuring the safety of the aircraft or persons on board.

(5) For the purposes of this regulation –

“munition of war” means any –

- (a) weapon or ammunition;
- (b) article containing an explosive, noxious liquid or gas; or
- (c) other thing,

which is designed or made for use in warfare or against persons, including parts, whether components or accessories, for such weapon, ammunition or article;

“sporting weapon” means any –

- (a) weapon or ammunition;
- (b) article containing an explosive, noxious liquid; or
- (c) other thing, including part, whether component or accessory, for such weapon, ammunition or article,

which is not a munition of war.

[Reg. 64 amended by reg. 30 of GN 17 of 2010 w.e.f. 1 February 2010.]

65. Carriage of dangerous goods

(1) (a) Without prejudice to these regulations, no person shall carry, cause to be carried, or in any manner be involved in the carriage of, dangerous goods unless the carriage of the dangerous goods is in conformity with –

- (i) Annex 18 of the Convention;
- (ii) the technical instructions of the carriage of dangerous goods issued, from time to time, by ICAO; and
- (iii) a dangerous goods manual approved under regulation 65A.

(b) Every operator of an aircraft registered in Mauritius, and flying for the purpose of public transport, shall establish training programmes relating to the carriage of dangerous goods and such programmes shall be subject to the approval of the Authority.

(2) Any person who contravenes, permits the contravention of or fails to comply with any regulation made under the Act relating to the carriage of dangerous goods shall commit an offence.

(3) This regulation and any other regulations made under the Act, relating to the carriage of dangerous goods, shall be in addition to, and not in derogation of, regulation 64.

[Reg. 65 amended by reg. 31 of GN 17 of 2010 w.e.f. 1 February 2010.]

65A. Dangerous goods manual

(1) No person shall, unless it is approved by the Authority, use a dangerous goods manual for the purpose of these regulations.

(2) Every person who intends to use a dangerous goods manual for the purpose of these regulations shall make an application to the Authority for the approval of the manual.

(3) The Authority shall not grant an application unless the manual is in conformity with the dangerous goods requirements issued by the Authority under regulation 135.

(4) Where the Authority grants an application made under paragraph (2), it shall issue a written approval.

[Reg. 65A inserted by reg. 32 of GN 17 of 2010 w.e.f. 1 February 2010.]

66. Method of carriage of persons

- (1) Subject to paragraph (2), no person shall be –
 - (a) in, or on, any part of an aircraft in flight which is not a part intended for the accommodation of persons;
 - (b) on the wings or undercarriage of an aircraft;
 - (c) in or on any object, other than a glider, towed by or attached to an aircraft in flight.
- (2) A person may have temporary access to any part of an aircraft –
 - (a) for the purpose of taking action necessary for the safety of the aircraft or of any person, animal or article on the aircraft; or
 - (b) in which cargo or stores are carried, and which is a part of the aircraft which was intended to be accessible to a person while the aircraft is in flight.

67. Exits and break-in markings

- (1) This regulation shall apply to every public transport aircraft registered in Mauritius.
- (2) Subject to paragraphs (3), (4), (5), (12) and (13), where an aircraft is carrying passengers, every exit from, and every internal door in, the aircraft shall –
 - (a) be in working order; and
 - (b) during take-off, landing or any emergency –
 - (i) be kept free from any obstruction; and
 - (ii) not be fastened by locking or otherwise to prevent, hinder or delay its use by passengers.
- (3) An exit may be obstructed by cargo where it is an exit which, in accordance with arrangements approved by the Authority, is not required to be used by passengers.
- (4) A door between the flight crew compartment, and any adjacent compartment to which passengers have access, may be locked or bolted where the commander of the aircraft so decides, to prevent access by passengers to the flight crew compartment.
- (5) Paragraph (2) shall not apply to an internal door so placed that it cannot prevent, hinder or delay the exit of passengers from the aircraft in an emergency if it is not in working order.
- (6) Every exit from an aircraft shall –
 - (a) be marked with instructions in the English language and diagrams to indicate the correct method of opening the exit;
 - (b) in the case of an exit intended to be used by passengers in normal circumstances, be marked with the word 'EXIT';
 - (c) in the case of an exit intended to be used by passengers in an emergency only, be marked with the words 'EMERGENCY EXIT'.
- (7) The markings under paragraph (6) shall be placed –
 - (a) on or near the inside surface of the door or other closure of the exit; and
 - (b) in the case of an exit which may be opened from outside the aircraft, on or near the exterior surface.
- (8) An aircraft shall, where its maximum total authorised mass is more than 3,600 kilogrammes, bear, on the exterior surface of its fuselage, markings to show the break-in areas of the aircraft.
- (9) A break-in area shall –
 - (a) be rectangular in shape;
 - (b) be marked by right-angled corner markings, every arm of which shall be 10 centimetres long along its outer edge and of a width of 2.5 centimetres; and
 - (c) have the words 'CUT HERE IN EMERGENCY' marked across its centre.
- (10) An aircraft shall, where its maximum total authorised mass exceeds 5,700 kilogrammes, be

marked, on the exterior of every exit intended to be used by passengers in an emergency, with a band not less than 5 centimetres wide outlining the exit.

(11) Every marking under this regulation shall –

- (a) be painted or otherwise permanently affixed;
- (b) except in the case of the markings required under paragraph (10), be red in colour, and, where the colour of the adjacent background is such as to render red markings not readily visible, be outlined in any other contrasting colour in such a manner as to render them readily visible;
- (c) in the case of the markings required under paragraph (10), be of a colour clearly contrasting with the background on which it appears; and
- (d) at all times, be kept clean and unobscured.

(12) Subject to paragraph (13), where not more than one exit from an aircraft becomes inoperative at a place where it is not reasonably practicable for it to be repaired or replaced, the aircraft may carry passengers until it next lands at a place where the exit may be repaired or replaced.

(13) Where an aircraft carries passengers in circumstances specified in paragraph (12) –

- (a) the number of passengers carried and the position of the seats which they will occupy shall be in accordance with the arrangements approved by the Authority; and
- (b) the operator shall, in relation to the inoperative exit, ensure that –
 - (i) the exit shall be fastened by locking or otherwise;
 - (ii) the words 'EXIT' or 'EMERGENCY EXIT' shall be covered; and
 - (iii) the exit shall be marked by a red disc at least 23 centimetres in diameter with a horizontal white bar across it bearing the words 'NO EXIT' in red letters.

68. Endangering safety of aircraft

No person shall act in a manner likely to endanger an aircraft or any person in an aircraft.

69. Use of electronic equipment on board an aircraft

No person shall operate a mobile phone, a personal computer or similar electronic equipment on board an aircraft at a time when the operation of such equipment is prohibited by a notice to that effect given by or on behalf of the commander of the aircraft.

70. Endangering safety of person or property

No person shall cause or permit an aircraft to endanger any person or property.

71. Drunkenness in aircraft

(1) No person shall be in a state of drunkenness whilst in an aircraft.

(2) No person, when acting as a member of the crew of any aircraft or being carried in any aircraft for the purpose of so acting, shall –

- (a) be under the influence of any psychoactive substance which might render him unable to safely and properly perform his duties;
- (b) engage in any problematic use of substances.

72. Smoking in aircraft

(1) Notices indicating when smoking is prohibited shall be exhibited in every aircraft registered in Mauritius so as to be visible from every passenger seat.

(2) No person shall smoke in a compartment of an aircraft registered in Mauritius at a time when smoking is prohibited in that compartment by a notice to that effect exhibited by, or on behalf of, the commander of the aircraft.

73. Authority of commander of aircraft

Every person in an aircraft registered in Mauritius shall obey every lawful command which the commander of that aircraft may give for the purpose of securing –

- (a) the safety of the aircraft and of persons or property carried in the aircraft; or

(b) the safety, efficiency or regularity of air navigation.

74. Stowaways

No person shall secrete himself for the purpose of being carried in an aircraft without the consent of the operator or commander of the aircraft or any other person entitled to give consent to his being carried in the aircraft.

75. Flying displays

(1) No person shall act as the organiser of a flying display (“flying display director”) unless he has been authorised by the Authority, in writing, under paragraph (4), for that flying display and complies with any condition specified in the authorisation.

(2) (a) The commander of an aircraft intending to participate in a flying display shall take all reasonable steps to satisfy himself, before he participates in the flying display, that –

- (i) the flying display director has been authorised under paragraph (4);
- (ii) the flight shall be in conformity with any relevant condition subject to which that authorisation may have been granted; and
- (iii) the pilot has been granted a pilot display authorisation under paragraph (5).

(b) The commander of an aircraft participating in a flying display for which authorisation has been granted shall comply with any condition subject to which that authorisation may have been granted.

(c) No person shall act as pilot of an aircraft participating in a flying display unless he holds an appropriate pilot display authorisation and he complies with any condition subject to which the authorisation may have been given.

(3) The flying display director shall not permit any person to act as pilot of an aircraft which participates in a flying display unless such person holds an appropriate pilot display authorisation.

(4) (a) The Authority shall grant an authorisation or a permission, required by virtue of paragraph (1), where it is satisfied that the applicant is a fit and competent person, having regard in particular to his previous conduct and experience, organisation, staffing and other arrangements, to safely organise the proposed flying display.

(b) The authorisation or permission, referred to in subparagraph (a), may be granted subject to such conditions, which may include conditions in respect of military aircraft, as the Authority may determine and shall, subject to regulation 85, remain in force for the period specified in the permission or authorisation.

(5) The Authority shall either unconditionally or subject to such conditions as it may determine –

- (a) grant a pilot display authorisation authorising the holder to act as pilot of an aircraft taking part in a flying display where it is satisfied that the applicant holds an appropriate pilot licence and is a fit person to hold the authorisation and is qualified by reason of his knowledge, experience, competence, skill, physical and mental fitness to fly in accordance therewith and, for that purpose, the applicant shall furnish such evidence and undergo such examination and test as the Authority may require; and
- (b) authorise a person to conduct such examination or test as it may specify.

(6) A pilot display authorisation granted, in accordance with paragraph (5), shall, subject to regulation 85, remain in force for the period indicated in the authorisation.

(7) A flying display director shall not permit any military aircraft to participate in a flying display unless it complies with any condition specified in respect of military aircraft subject to which permission for the flying display may have been granted.

(8) This regulation shall not apply to –

- (a) an aircraft race or contest;
- (b) an aircraft taking part in such a race or contest; or
- (c) the commander or pilot of an aircraft, whether or not the race or contest is held in association with a flying display.

76. Protection of aircrew from cosmic radiation

- (1) Every operator shall take appropriate measures to –
 - (a) assess the exposure to cosmic radiation, when in flight, of those crew members who are liable to be subject to cosmic radiation in excess of one *milliSievert* per annum;
 - (b) take into account the assessed exposure when organising work schedules with a view to reducing the risk to highly exposed crew members; and
 - (c) inform the crew members concerned of the health risks their work involves.

(2) The operator shall ensure that, in relation to a pregnant crew member, the conditions of exposure to cosmic radiation when she is in flight are such that the corresponding amount to the foetus shall be as low as reasonably achievable and be unlikely to exceed one *milliSievert* during the remainder of the pregnancy.

(3) Nothing in paragraph (2) shall require the operator to take any action in relation to a crew member unless he has been notified in writing that she is pregnant.

- (4) In this regulation –

“highly exposed crew” means a crew member likely to be subject to cosmic radiation exceeding one *milliSievert* per year frequently;

“*milliSievert*” means 0.001 joule per kilogramme;

“year” means any period of 12 months.

PART VII – FATIGUE OF CREW

77. Application of Part VII

- (1) This Part shall –
 - (a) apply to an aircraft registered in Mauritius which is –
 - (i) engaged on a flight for the purpose of public transport; or
 - (ii) operated by an air transport undertaking; but
 - (b) not apply to an aircraft which is engaged on a flight made only for the purpose of instruction in flying given by, or on behalf of, a –
 - (i) flying club;
 - (ii) flying school; or
 - (iii) person which is not an air transport undertaking.

78. Operator’s responsibilities for crew fatigue

- (1) The operator of an aircraft shall not cause or permit it to fly unless –
 - (a) he has established a scheme for the control of flight time and duty periods for every member of the crew carried in the aircraft;
 - (b) the scheme has been approved by the Authority, subject to such terms and conditions as it may determine;
 - (c) the scheme has been incorporated –
 - (i) in an operations manual referred to in regulation 41; or
 - (ii) where an operations manual is not required under that regulation, in a document, a copy of which has been made available to every crew member flying in that aircraft; and
 - (d) he has taken all such steps as are reasonably practicable to ensure that the provisions of the scheme will be complied with in relation to every crew member flying in that aircraft.

(2) The operator of an aircraft shall not cause or permit any person to fly in the aircraft as a crew member –

- (a) where he knows, or has reason to believe, that the person is suffering from or, having regard to the circumstances of the flight to be undertaken, is likely to suffer from, such fatigue while he is flying as may endanger the safety of the aircraft or its occupants; and
 - (b) unless he has in his possession, in respect of the 28 days immediately preceding the flight, an accurate record of all the flight times of that person and brief particulars of the nature of the functions performed by him in the course of those flights.
- (3) The record referred to in paragraph (2)(b) shall, subject to regulation 84, be preserved by the operator of the aircraft for a period of 12 months after the flight referred to in that paragraph.
- (4) In this regulation –
- “flight duty period” means a continuous period of duty which includes a flight, or series of flights, together with all duties that a flight crew member may be required to carry out from the moment that he reports at his place of employment on the day of the flight until he is relieved of his duties, having completed the flight, or series of flights, as a crew member.

[Reg. 78 amended by reg. 33 of GN 17 of 2010 w.e.f. 1 February 2010.]

79. Responsibilities of crew for crew fatigue

(1) No person shall act as a crew member of an aircraft where he knows or suspects that he is suffering from or, having regard to the circumstances of the flight to be undertaken, is likely to suffer from such fatigue as may endanger the safety of the aircraft or its occupants.

(2) No person shall act as a member of the flight crew of an aircraft unless he has ensured that the operator of the aircraft is aware of his flight times during the 28 days preceding the flight.

80. Responsibilities of flight crew for flight times

(1) No person shall act as a member of the flight crew of an aircraft where, at the beginning of the flight, the aggregate of all his flight times –

- (a) during the 28 consecutive days immediately preceding the day on which the flight begins, exceeds 100 hours; and
- (b) during the period of 12 months expiring at the end of the previous month, exceeds 900 hours.

(2) Paragraph (1) shall not apply to an aircraft –

- (a) the maximum total authorised mass of which is not more than 1,600 kilogrammes and which is not flying for the purpose of public transport or aerial work; or
- (b) which is not flying for the purpose of public transport nor operated by an air transport undertaking where, at the time when the flight begins, the aggregate of all the flight times of any member of the flight crew, since he was last medically examined and found fit by a person approved by the Authority under regulation 33(11), does not exceed 25 hours.

PART VIII – DOCUMENTS AND RECORDS

81. Documents to be carried

(1) An aircraft shall not fly in or over Mauritius unless it carries the documents which it is required to carry under the law of the State in which it is registered.

(2) In relation to an aircraft registered in Mauritius, the documents specified in the Fourteenth Schedule –

- (a) shall, during a flight, be carried in the aircraft; or
- (b) where the flight is intended to begin and end at the same aerodrome and does not include passage over the territory of any State other than Mauritius, may be kept at that aerodrome.

82. Records to be kept

The operator of a public transport aircraft registered in Mauritius shall, in respect of any flight by that aircraft during which it flies at an altitude of more than 49,000 feet, keep a record, in the prescribed

manner, of the total dose of cosmic radiation to which the aircraft is exposed together with the names of the crew members during the flight.

83. Production of documents and records

- (1) The commander of an aircraft shall, on demand, produce to an authorised person –
 - (a) the certificates of registration and airworthiness in force in respect of the aircraft;
 - (b) the licences of its flight crew; and
 - (c) any other document that the aircraft is required, under regulation 81, to carry during a flight.

- (2) The operator of an aircraft registered in Mauritius shall, on demand, produce to an authorised person any of the following documents or records which are required under these regulations to be in force or carried, preserved or made available –

- (a) documents A, B, C and G specified in the Fourteenth Schedule;
- (b) the aircraft log book, engine log books and variable pitch propeller log books required to be kept under regulation 27;
- (c) the mass schedule, if any, required to be preserved under regulation 28;
- (d) in the case of a public transport aircraft or aerial work aircraft, documents D, E, and F specified in the Fourteenth Schedule;
- (e) any record of flight time, required to be preserved under regulation 78(3), and any other document or information, in the possession or control of the operator, that the authorised person may require for the purpose of determining whether the record is complete and accurate;
- (f) any operations manual that is required to be made available under regulation 41;
- (g) any record made by any flight data recorder; and
- (h) any record made by cosmic radiation detection equipment together with a record of the names of the crew members of the aircraft required to be kept under regulation 82.

- (3) The holder of a licence granted or rendered valid shall, on demand, produce to an authorised person the licence together with any certificate of validation or medical certificate attached to the licence.

- (4) Every person required by regulation 37 to keep a personal flying log book shall, on demand, produce the log book to an authorised person where the demand is made within 2 years from the date of the last entry in the log book.

- (5) An authorised person shall have the power to inspect and copy any certificate, licence, log book, document or record which he has power to require to be produced to him under this regulation.

84. Preservation of documents and records

- (1) Subject to paragraphs (2), (3) and (4), any document or record required, under these regulations, to be kept by any person, by reason of his being the operator of an aircraft registered in Mauritius, shall –

- (a) where he ceases to be the operator of the aircraft, continue to be preserved by him as if he had not ceased to be the operator; and
- (b) in the event of his death, be preserved by his personal representative.

- (2) Where a person ceases to be the operator of an aircraft registered in Mauritius, he or his personal representative, as the case may be, shall, where another person becomes the operator of the aircraft and the aircraft remains registered in Mauritius, deliver to that other person, on demand, the following documents which are in force or required to be preserved in respect of that aircraft –

- (a) the certificates of maintenance review and release to service;
- (b) the log books;
- (c) the mass schedule; and

(d) any record made by a flight data recorder and preserved in accordance with regulation 59(2).

(3) The operator of an aircraft registered in Mauritius or his personal representative, as the case may be, shall, where an engine or variable pitch propeller has been removed from the aircraft and installed in another aircraft operated by another person and registered in Mauritius, deliver to that other person, on demand, the log book relating to that engine or propeller.

(4) The operator of an aircraft registered in Mauritius or his personal representative, as the case may be, shall, where any person in respect of whom he has kept a record under regulation 78 becomes a member of the flight crew of a public transport aircraft registered in Mauritius and operated by another person, deliver that record to that other person, on demand.

(5) A person to whom a document or record has been delivered under this regulation shall deal with the document or record as if it had been kept or preserved by him in the first instance.

85. Revocation, suspension and variation of certificates, licences and other documents

(1) The Authority may, if it thinks fit, provisionally suspend or amend any certificate, licence, approval, permission, exemption, authorisation or other document issued, granted or having effect under these regulations, pending inquiry into, or consideration of, the case.

(2) The Authority may, on sufficient ground being shown to its satisfaction, after due inquiry, revoke, suspend or amend any certificate, licence, approval, permission, exemption, authorisation or other document referred to in paragraph (1).

(3) The holder, or any other person having the possession or custody, of any certificate, licence, approval, permission, exemption or other document which has been revoked, suspended or amended under this regulation shall, on being required to do so by the Authority, surrender it to the Authority.

(4) The breach of a condition –

(a) subject to which a certificate, licence, approval, permission, exemption or other document, other than a licence issued in respect of an aerodrome, has been granted or issued; or

(b) which has effect under these regulations,

shall, in the absence of any contrary provision in the document, render the document invalid during the continuance of the breach.

(5) Notwithstanding paragraph (1), a flight manual, performance schedule or other document incorporated by reference in a certificate of airworthiness may be amended, on sufficient ground being shown to the satisfaction of the Authority, whether or not after due inquiry.

86. Offences in relation to documents and records

(1) No person shall, with intent to deceive –

(a) use a certificate, licence, approval, permission, exemption or other document issued, having effect or required under these regulations, which has been forged, altered, revoked or suspended, or to which he is not entitled;

(b) lend to any other person a document referred to in subparagraph (a) or allow it to be used by any other person; or

(c) make a false representation for the purpose of procuring for himself, or any other person, the grant, issue, renewal or variation of a document referred to in subparagraph (a).

(2) No person shall –

(a) damage, alter or render illegible a logbook or other record required under these regulations to be maintained, or an entry made in it;

(b) make, procure or assist in the making of any false entry in, or material omission from, a log book or record referred to in subparagraph (a); or

(c) destroy a logbook or record referred to in subparagraph (a) during the period for which it is required to be preserved under these regulations.

(3) An entry made in writing in a logbook or other record required under these regulations shall be made in ink or indelible pencil.

(4) No person shall –

- (a) make, in a load sheet, an entry that is incorrect in any material particular or omit to make an entry which is material;
- (b) purport to issue a certificate under these regulations without being authorised to do so; or
- (c) issue a certificate under these regulations without satisfying himself that every statement in the certificate is correct.

(5) In this regulation, a reference to a document includes a reference to a copy of that document.

PART IX – MOVEMENT OF AIRCRAFT AND AIR TRAFFIC SERVICES

87. Rules of air and air traffic control

(1) The operator and, where appropriate, the commander of an aircraft in or over Mauritius shall comply with the Rules of the air and air traffic control or in the Civil Aviation Navigation Requirements published by the Authority, whichever is applicable.

(2) No aircraft registered in Mauritius, or engaged in a flight undertaken by an operator having its principal place of business or permanent residence in Mauritius, shall be operated otherwise than in conformity with the applicable air traffic control rules of the State in whose airspace it is flying, including any rule or procedure for interception of aircraft laid down by the competent authority of that State.

88. Contravention of Rules of air and air traffic control

(1) Subject to paragraph (2), any person who contravenes, or permits the contravention of, the Rules of the air and air traffic control shall commit an offence.

(2) It shall be lawful for the Rules of the air and air traffic control to be departed from, to the extent necessary –

- (a) for avoiding immediate danger; or
- (b) for complying with the law of any State other than Mauritius, within which the aircraft then is.

(3) Where any departure from the Rules of the air and air traffic control is made for the purpose of avoiding immediate danger, the commander of the aircraft shall cause written particulars of the departure, and of the circumstances giving rise to it, to be given within 10 days thereafter to the competent authority of the State in whose territory the departure was made or, where the departure was made over the high seas, to the Authority.

(4) Nothing in the Rules of the air and air traffic control shall exonerate any person from the consequences of any neglect in the use of lights or signals or of any neglect of any precautions required by ordinary aviation practice or special circumstances of the case.

89. Power to prohibit or restrict flying

(1) Where the Minister considers it necessary in the public interest to restrict or prohibit flying by reason of –

- (a) the intended gathering or movement of a large number of persons;
- (b) the intended holding of an aircraft race or contest or a flying display; or
- (c) national defence or any other reason affecting the public interest,

he may issue directions prohibiting, restricting or imposing conditions on the flight by any aircraft, whether or not registered in Mauritius, in any airspace over Mauritius or in the neighbourhood of an offshore installation or in airspace in respect of which the Government of Mauritius has, in pursuance of international arrangements, undertaken to provide navigation services for aircraft.

(2) Any person who contravenes any direction issued under paragraph (1) shall commit an

offence.

(3) Where the commander of an aircraft becomes aware that the aircraft is flying in contravention of any direction issued under paragraph (1)(c), he shall, unless otherwise instructed pursuant to paragraph (4), cause the aircraft to leave the area to which the regulations relate by flying to the least possible extent over such area and the aircraft shall not start descending while over such area.

(4) The commander of an aircraft flying within an area, in relation to which directions have been issued under paragraph (1)(c), or airspace, notified as a danger area, shall forthwith comply with instructions given by radio by the appropriate air traffic control unit or by, or on behalf of, the person responsible for safety within the relevant airspace.

90. Balloons, kites, airships, gliders and parascending parachutes

(1) Except with the permission, in writing, of the Authority and in accordance with any condition subject to which that permission may have been granted, no person shall –

- (a) fly a balloon in captive or tethered flight within 60 metres of any vessel, vehicle or structure except with the permission of the person in charge of any such vessel, vehicle or structure;
- (b) launch a glider or parascending parachute by winch and cable or by ground tow to a height of more than 60 metres above ground level;
- (c) fly a balloon in captive flight within 5 kilometres of a notified aerodrome;
- (d) fly a balloon in captive or tethered flight at a height measured to the top of the balloon of more than 60 metres above ground level;
- (e) fly a balloon, exceeding 2 metres in any linear dimension at any stage of its flight, including any basket or other equipment attached to the balloon, in controlled airspace;
- (f) fly a kite within 5 kilometres of a notified aerodrome;
- (g) fly a kite at a height of more than 60 metres above ground level; or
- (h) launch a parascending parachute by winch and cable or by ground tow within 5 kilometres of a notified aerodrome.

(2) A balloon, when in captive flight, shall be securely moored and shall not be left unattended unless it is fitted with a device which ensures its automatic deflation if it breaks free of its moorings.

(3) An airship with a capacity exceeding 3,000 cubic metres shall not be moored, other than at a notified aerodrome, except with the permission, in writing, of the Authority and in accordance with any condition subject to which that permission may have been granted.

(4) No airship with a capacity not exceeding 3,000 cubic metres shall, unless it is moored on a notified aerodrome, be moored –

- (a) within 2 kilometres of a congested area; or
- (b) within the aerodrome traffic zone of a notified aerodrome,

except with the permission, in writing, of the Authority and in accordance with any condition subject to which that permission may have been granted.

(5) An airship when moored in the open shall be securely moored and shall not be left unattended.

(6) (a) No person shall cause or permit a group of small balloons, exceeding 100 in number, to be simultaneously released at a single site except with the permission, in writing, of the Authority and in accordance with any condition subject to which such a permission may have been granted.

(b) For the purposes of subparagraph (a) –

“simultaneously released at a single site” means the release of a specified number of balloons during a period not exceeding 15 minutes from within an area not exceeding one kilometre square.

(7) No permission shall be granted to a person under this regulation unless that person pays the appropriate fee, specified in the Second Schedule.

[Reg. 90 amended by reg. 34 of GN 17 of 2010 w.e.f. 1 February 2010.]

91. Remotely piloted aircraft

(1) No person shall cause or permit any article or animal, whether or not that article or animal is attached to a parachute, to be dropped from a remotely piloted aircraft.

(2) No person in charge of a remotely piloted aircraft shall fly the aircraft unless he is reasonably satisfied that the flight may safely be made.

(3) A person in charge of a remotely piloted aircraft shall, for the purpose of avoiding collisions, maintain direct and unaided visual contact with the aircraft sufficient to monitor its flight path in relation to other aircraft, persons, vehicles, vessels and structures.

(4) No person in charge of a remotely piloted aircraft shall fly the aircraft –

(a) in Class A airspace, Class C airspace, Class D airspace or Class E airspace without the permission of the Authority;

(b) within an aerodrome traffic zone during the notified hours of watch of the air traffic control unit at that aerodrome unless permission of the air traffic control unit is obtained; or

(c) at a height of more than 400 feet above the surface unless it is flying in airspace specified in subparagraph (a) or (b) and in accordance with the requirements for that airspace.

(5) Where a person intends to fly a remotely piloted aircraft –

(a) in an airspace referred to in paragraph (4)(a), he shall make an application seeking the permission of the Authority in such manner as the Authority may determine;

(b) in a zone and during the time referred to in paragraph (4)(b), he shall make an application to the air traffic control unit in such manner as the air traffic control unit may determine.

(6) (a) Where the applicant meets the conditions set out in the civil airworthiness requirements specified in regulation 135 for flying a remotely piloted aircraft in the airspace referred to in paragraph (5)(a), the Authority shall, on payment of the appropriate fee specified in the Sixteenth Schedule, grant permission to the applicant.

(b) Where the air traffic control unit considers that the applicant may fly a remotely piloted aircraft in a zone and during the time referred to in paragraph (5)(b) without threat to flight safety, the air traffic control unit shall, on payment of the appropriate fee specified in the Sixteenth Schedule, grant permission to the applicant.

[Reg. 91 revoked and replaced by reg. 4 of GN 139 of 2016 w.e.f. 1 July 2016.]

91A. Remotely piloted surveillance aircraft

(1) No person in charge of a remotely piloted surveillance aircraft shall, except with the permission of the Authority, fly the aircraft –

(a) over a congested area or within 150 metres of that area;

(b) over an organised open-air assembly of more than 500 persons or within 150 metres of that assembly;

(c) within 50 metres of any vessel, vehicle or structure which is not under the control of the person in charge of the aircraft; or

(d) subject to paragraphs (2) and (3), within 50 metres of any person.

(2) Subject to paragraph (3), no remotely piloted surveillance aircraft shall be flown within 30 metres of a person during take-off or landing.

(3) Paragraphs (1)(d) and (2) shall not apply to a person in charge of a remotely piloted surveillance aircraft or a person under the control of the person in charge of the aircraft.

(4) Nothing in this regulation shall be construed as a derogation to the Data Protection Act.

(5) This regulation shall be in addition to, and not in derogation from, regulation 91.

(6) Where a person intends to fly a remotely piloted surveillance aircraft in an area referred to in paragraph (1), he shall make an application seeking the permission of the Authority in such manner as the Authority may determine.

(7) Where the applicant meets the conditions set out in the civil airworthiness requirements

specified in regulation 135 for flying a remotely piloted surveillance aircraft in the area referred to in paragraph (1), the Authority shall, on payment of the appropriate fee specified in the Sixteenth Schedule, grant permission to the applicant.

[Reg. 91A inserted by reg. 5 of GN 139 of 2016 w.e.f. 1 July 2016.]

91B. Remotely piloted aircraft or remotely piloted surveillance aircraft used for aerial work

(1) No person in charge of a remotely piloted aircraft or a remotely piloted surveillance aircraft shall use the aircraft for the purpose of aerial work except in accordance with a permission granted by the Authority.

(2) Where a person intends to use a remotely piloted aircraft or remotely piloted surveillance aircraft for the purpose of aerial work, he shall make an application seeking the permission of the Authority in such manner as the Authority may determine.

(3) Where the applicant meets the conditions set out in the civil airworthiness requirements specified in regulation 135 for using a remotely piloted aircraft or remotely piloted surveillance aircraft for the purpose of aerial work, the Authority shall, on payment of the appropriate fee specified in the Sixteenth Schedule, grant permission to the applicant.

[Reg. 91B inserted by reg. 5 of GN 139 of 2016 w.e.f. 1 July 2016.]

91C. Remotely piloted aircraft or remotely piloted surveillance aircraft used for leisure or recreational purposes

(1) Regulations 91 and 91A shall not apply to a remotely piloted aircraft or a remotely piloted surveillance aircraft weighing not more than 7 kilogrammes, which is flown strictly for leisure or recreational purposes, provided that the aircraft is not flown –

- (a) in Class A airspace, Class C airspace, Class D airspace or Class E airspace without the permission of the Authority;
- (b) within an aerodrome traffic zone during the notified hours of watch of the air traffic control unit at that aerodrome unless permission of the air traffic control unit is obtained;
- (c) at a height exceeding 400 feet above the surface unless it is flying in airspace specified in subparagraph (a) or (b) and in accordance with the requirements for that airspace;
- (d) over the property of any person unless the permission of that person has been obtained;
- (e) over any area to which the public has access; or
- (f) at night.

(2) No person shall fly, for leisure or recreational purposes, a remotely piloted aircraft or a remotely piloted surveillance aircraft which weighs more than 7 kilogrammes but less than 20 kilogrammes without its fuel, but including any article or equipment installed in or attached to the aircraft at the commencement of its flight.

(3) Where a person intends to fly, for leisure or recreational purposes, a remotely piloted aircraft or a remotely piloted surveillance aircraft in an airspace specified in paragraph 1(a) or in a zone and at a time specified in paragraph 1(b), he shall make an application seeking the permission of the Authority in such manner as the Authority may determine.

(4) Where the applicant meets the conditions set out in the civil airworthiness requirements specified in regulation 135 for flying a remotely piloted aircraft or a remotely piloted surveillance aircraft weighing not more than 7 kilogrammes for leisure or recreational purposes, the Authority shall, on payment of the appropriate fee specified in the Sixteenth Schedule, grant permission to the applicant.

[Reg. 91C inserted by reg. 5 of GN 139 of 2016 w.e.f. 1 July 2016.]

92. Approval for the provision of air traffic services

(1) No person, in charge of the provision of an air traffic control service, other than the Authority, shall provide such a service in respect of Mauritian airspace or airspace outside Mauritius for which Mauritius has, in pursuance of International arrangements, undertaken to provide air navigation services otherwise than under, and in accordance with, the terms of an air traffic control approval granted by the Minister.

(2) An application for approval for the provision of an air traffic control service shall be made to the Minister in such form as the Authority may approve.

(3) The Minister shall grant an air traffic control approval where he is satisfied that the applicant is

competent, having regard to his organisation, staffing, equipment, maintenance and other arrangements, to provide a service which is safe for use by aircraft.

(4) An air traffic control approval may be granted subject to such conditions as the Authority may determine and shall, subject to regulation 85, remain in force for the period specified in the approval.

93. Manual of air traffic services

No person shall provide an air traffic control service at any place unless –

- (a) the service is provided in accordance with the standards and procedures specified in a manual of air traffic services in respect of that place;
- (b) the manual is produced to the Authority within a reasonable time after a request for its production is made by the Authority; and
- (c) such amendments or additions have been made to the manual as the Authority may, from time to time, require.

94. Licensing of air traffic controllers and student air traffic controllers

(1) (a) Subject to subparagraph (b), the Authority may grant a licence, subject to such condition as it may determine, to any person to act as an air traffic controller or a student air traffic controller where it is satisfied that the applicant is a fit person to hold the licence and is qualified by reason of his knowledge, experience, competence, skill and physical and mental fitness so to act, and, for that purpose, the applicant shall furnish such evidence and undergo such examinations and tests, including in particular medical examinations, and undertake such approved courses of training as the Authority may require of him.

(b) The Authority shall not grant a student air traffic controller's licence to any person under the age of 18 years.

(c) The Authority shall not grant an air traffic controller's licence to any person under the age of 21 years.

(2) (a) Subject to regulation 85, a licence to act as an air traffic controller or a student air traffic controller shall remain in force for the period indicated in the licence and may be renewed by the Authority, from time to time, where it is satisfied that the applicant is a fit person and is qualified.

(b) Where no period is indicated in the licence, it shall remain in force for the lifetime of the holder.

(3) The Authority may include in an air traffic controller's licence, subject to such condition as it may determine, and where it is satisfied that the applicant is qualified to act in the capacity to which the rating relates, a rating of any of the classes set out in the Sixteenth Schedule, specifying the type of air traffic control service which the licence holder is competent to provide and such rating shall form part of the licence.

(4) (a) The holder of an air traffic controller's licence shall not be entitled to exercise the privileges of a rating contained in the licence at any place or for any sector or with any type of radar equipment unless the licence includes a valid certificate of competence, in respect of that rating, which is appropriate to that place or sector and that equipment, if any, and which certificate complies with subparagraph (b).

(b) A valid certificate of competence shall not be appropriate to the exercise of the privileges of a rating at any place or for any sector or with any type of radar equipment unless the certificate –

- (i) specifies that place or sector and that type of radar equipment, if any, with the aid of which the service is to be provided;
- (ii) certifies that the person signing the endorsement is satisfied that on a date specified in the certificate, the holder of the licence of which the certificate forms part, has passed an appropriate test of his ability to exercise the privileges of the rating at the place or for the sector and with the type of radar equipment, if any, specified in the certificate; and
- (iii) specifies the date on which it was signed.

(c) (i) A valid certificate shall be signed by a person authorised by the Authority to do so.

(ii) A certificate shall be valid, subject to paragraph (2), for 13 months after the date of the test which it certifies.

(5) (a) Where throughout any period of 90 days the holder of a licence has not at any time provided, at a particular place or for a particular sector and with the aid of the type of radar equipment, if any, specified in the certificate of competence, the type of air traffic control service specified in the rating to which the certificate relates, the certificate of competence shall, without prejudice to the Authority's powers under regulation 85, cease to be valid for that place or sector at the end of that period.

(b) Where a certificate of competence ceases to be valid for a place or sector, the licence holder shall –

- (i) forthwith inform the person, who is approved by the Authority under regulation 92 to provide an air traffic control service at that place or for that sector, of that fact; and
- (ii) forward the licence to a person, approved by the Authority for that purpose, who shall endorse the licence accordingly and return it to the holder forthwith.

(6) Every licence to act as a student air traffic controller shall be valid only for the purpose of authorising the holder to act as an air traffic controller under the supervision of another person who is present at the time, is the holder of an air traffic controller's licence entitling him to provide, unsupervised, the type of air traffic control service which is being provided by the student air traffic controller and is approved by the Authority for this purpose.

(7) A licence to act as an air traffic controller or a student air traffic controller shall not be valid unless the licence holder has signed his name thereon in ink with his ordinary signature.

(8) Every holder of an air traffic controller's licence or a student air traffic controller's licence shall, on such occasion as the Authority may require, submit himself to such examinations and tests, including in particular medical examinations, and furnish such evidence as to his knowledge, experience, competence and skill, and undergo such approved courses of training, as the Authority may require.

(9) (a) On the basis of the medical examinations referred to in paragraph (8), the Authority, or any person approved by it as competent to do so, may issue a medical certificate subject to such conditions as it or he may determine to the effect that the licence holder has been assessed as fit to perform the functions to which the licence relates.

(b) The certificate shall, subject to regulation 85, be valid for such period as is specified in the certificate and shall form part of the licence.

(10) (a) The holder of an air traffic controller's licence shall not act as an air traffic controller unless his licence includes a medical certificate issued and in force under paragraph (9).

(b) The holder of a student air traffic controller's licence shall not act in accordance with paragraph (6) unless his licence includes a medical certificate issued and in force under paragraph (9).

(11) For the purpose of this Part and the Sixteenth Schedule –

“acting as an air traffic controller” means giving instructions or advice or instructions and advice by means of radio signals to aircraft in the interests of safety, directly or indirectly, via a person acting in accordance with regulation 95(3) .

95. Power to act as air traffic controller

(1) Subject to paragraphs (3), (4) and (5), no person shall act as an air traffic controller or hold himself out, whether by use of a radio call sign or in any other way, as a person who may so act unless he is the holder of, and complies with the terms of –

- (a) a valid student air traffic controller's licence granted under these regulations and is supervised in accordance with regulation 94(6);
- (b) a valid air traffic controller's licence so granted authorising him to provide that type of service at that place or for that sector and with the type of radar equipment being used, if any; or
- (c) a valid air traffic controller's licence so granted which does not authorise him to provide that type of service at that place or for that sector and with the type of radar equipment being used, if any, but he is supervised as though he was a holder of a student air traffic controller's licence.

(2) No person shall act as an air traffic controller unless he has identified himself in such a

manner as the Authority may determine.

(3) A licence shall not be required by any person who, acting in the course of his employment, passes on such instructions or advice as he has been instructed so to do by the holder of an air traffic controller's licence entitling its holder to give such instructions or advice.

(4) Nothing under this regulation shall prohibit the holder of a valid air traffic controller's licence from providing, at any place or for any sector for which the licence includes a valid certificate of competence, information to an aircraft in flight in the interests of safety.

(5) A public officer may act as an air traffic controller without a licence where the Authority is satisfied that he meets the requirements of age, knowledge, experience, skill and medical fitness as specified in Chapter 4 of Annex 1 to the Convention.

96. Incapacity of air traffic controllers

(1) Every holder of an air traffic controller's or a student air traffic controller's licence granted under regulation 94 who –

- (a) suffers any personal injury or illness involving incapacity to undertake the functions to which his licence relates for a period of 20 consecutive days; or
- (b) in the case of a woman, has reason to believe that she is pregnant,

shall, as soon as possible, inform the Authority, in writing, of such injury, illness or pregnancy.

(2) The holder of an air traffic controller's or a student air traffic controller's licence shall not resume the functions relating to his licence on the expiry of the period of injury or illness, referred to in paragraph (1)(a), unless –

- (a) he has been medically examined under arrangements made by the Authority and pronounced fit to resume his functions under the licence; or
- (b) the Authority has granted him an exemption from the requirement of a medical examination subject to such conditions as the Authority may determine and he abides by those conditions.

(3) The holder of an air traffic controller's licence, a student air traffic controller's licence or an unlicensed public officer acting as air traffic controller under regulation 95(5) shall not –

- (a) be under the influence of any psychoactive substance which may render him unable to safely and properly perform his duties; or
- (b) engage in any problematic use of substances.

(4) No person holding an air traffic controller's licence, a student air traffic controller's licence or an unlicensed public officer shall act as an air traffic controller where he knows or suspects that he is suffering from or, having regard to the circumstances of the period of duty to be undertaken, is likely to suffer from such fatigue as may endanger the safety of any aircraft to which an air traffic control service may be provided.

97. Approval of flight information service officers

(1) (a) Subject to subparagraph (b), the Authority shall grant an approval, subject to such condition as it may determine, to any person to act as a flight information service officer where it is satisfied that the applicant is a fit person to be granted such an approval and is qualified by reason of his knowledge, competence, skill and physical and mental fitness so to act and, for that purpose, the applicant shall furnish such evidence and undergo such examinations and tests and undertake such approved courses of training as the Authority may require of him.

(b) The Authority shall not grant an approval referred to in subparagraph (a) to any person under the age of 20 years.

(2) (a) Subject to subparagraph (b) and regulation 85, an approval to act as a flight information service officer shall remain in force for the period indicated in the approval and may be renewed by the Authority from time to time, on being satisfied that the applicant is a fit and qualified person.

(b) Where no period is indicated in the approval, it shall remain in force, subject to paragraph (1), for the lifetime of the holder.

(3) (a) The holder of a flight information service officer's approval shall not be entitled to provide a flight information service at an aerodrome or area control centre unless that aerodrome or area control centre has been specified in the approval given by the Authority for the purpose.

(b) Where, throughout any period of 90 days, the holder of the approval has not, at any time, provided a flight information service at a particular aerodrome or area control centre, the approval shall cease to be valid for that aerodrome or area control centre at the end of that period until the approval has been revalidated in respect of that aerodrome or area control centre by the Authority for that purpose.

(4) Every holder of a flight information service officer's approval shall, on such occasion as the Authority may require, submit himself to such examinations and tests and furnish such evidence as to his knowledge, experience, competence and skill and undergo such approved courses of training, as the Authority may require.

98. Prohibition of unapproved flight information service officers

(1) No person shall, at an aerodrome or area control centre, provide a flight information service, or hold himself out, whether by use of a radio call sign or in any other way, as a person who may provide such a service unless he is the holder of, and complies with the terms of, a flight information service officer's approval, granted under regulation 97, authorising him to provide such a service at that aerodrome or area control centre.

(2) No person shall provide a flight information service unless he has identified himself in such a manner as the Authority may determine.

99. Flight information service manual

No person shall provide a flight information service at an aerodrome or area control centre unless

- (a) the service is provided in accordance with the standards and procedures specified in a flight information service manual approved by the Authority in respect of that aerodrome or area control centre;
- (b) the manual is produced to the Authority within a reasonable time after a request for its production is made by the Authority; and
- (c) such amendments or additions have been made to the manual as the Authority may, from time to time, determine.

100. Approval of courses and persons

The Authority may, for the purpose of regulation 97, and subject to such condition as it may determine –

- (a) approve any course of training or instruction;
- (b) authorise a person to conduct such examinations or tests as it may specify; and
- (c) approve a person to provide any course of training or instruction.

PART X – AERODROMES, AERONAUTICAL LIGHTS AND DANGEROUS LIGHTS

101. Use of aerodrome

(1) An aircraft shall not take off or land at a place in Mauritius other than –

- (a) an aerodrome licensed for the take-off and landing of such aircraft; or
- (b) a Government aerodrome, or an aerodrome owned or managed by the Authority, notified as available for the take-off and landing of such aircraft, or in respect of which the person in charge of the aerodrome has given his permission for the particular aircraft to take off or land, as the case may be; or
- (c) any other place for which permission has been obtained from the Authority,

and it shall do so in accordance with any condition subject to which the aerodrome may have been licensed or notified, or subject to which such permission may have been given.

(2) Subject to paragraph (3), paragraph (1) shall apply to –

- (a) aeroplanes of a maximum total authorised mass of more than 2,730 kilogrammes and which are flying for the purpose of –
 - (i) the public transport of passengers;
 - (ii) instruction in flying given to any person for the purpose of becoming qualified for the grant of a pilot's licence or inclusion of an aircraft rating or a night rating in a licence; or

- (iii) carrying out flying tests in respect of the grant of a pilot's licence or inclusion of an aircraft rating or a night rating in a licence;
- (b) aeroplanes of a maximum total authorised mass of not more than 2,730 kilogrammes engaged on –
 - (i) scheduled journeys for the purpose of the public transport of passengers; or
 - (ii) flights for the purpose of the public transport of passengers beginning and ending at the same aerodrome; or
 - (iii) flights for the purpose of –
 - (A) instruction in flying given to any person for the purpose of becoming qualified for the grant of a pilot's licence or inclusion of an aircraft rating or a night rating in a licence; or
 - (B) a flying test in respect of the grant of a pilot's licence or inclusion of an aircraft rating or a night rating in a licence; or
 - (iv) flights for the purpose of the public transport of passengers at night;
- (c) helicopters and gyroplanes engaged on such flights as are specified in subparagraph (b); and
- (d) gliders, other than gliders being flown under arrangements made by a flying club, and carrying no person other than a member of the club, which are flying for the purpose of the public transport of passengers or instruction in flying.

(3) (a) The person in charge of any area in Mauritius intended to be used for the taking off or landing of helicopters at night, other than such a place as is specified in paragraph (1), shall cause to be in operation, whenever a helicopter flying for the purpose of the public transport of passengers is taking off or landing at that area by night, such lighting as will enable the pilot of the helicopter –

- (i) in the case of landing, to identify the landing area in flight, determine the landing direction and make a safe approach and landing; and
- (ii) in the case of taking off, to make a safe take-off.

(b) A helicopter flying for the purpose of the public transport of passengers at night shall not take off or land at a place to which subparagraph (a) applies unless such lighting is in operation.

102. Use of Government aerodrome

The Minister may, subject to such terms and conditions as he may determine, cause a Government aerodrome to be notified in the Gazette, or in such manner as he considers appropriate, as an aerodrome available for the take-off and landing of any aircraft engaged on flights for the purpose of the public transport of passengers or instruction in flying.

[Reg. 102 amended by reg. 35 of GN 17 of 2010 w.e.f. 1 February 2010.]

103. Licensing of aerodrome

(1) An application for a licence to operate an aerodrome in Mauritius shall be made to the Minister in such form and manner as the Authority may determine.

(2) On receipt of an application under paragraph (1), the Minister may –

- (a) direct the applicant to furnish any additional information that it may require; and
- (b) where he is satisfied, having regard to –
 - (i) the applicant's previous conduct and experience;
 - (ii) his equipment, organisation and staffing;
 - (iii) the arrangements that he proposes to make to ensure that the aerodrome and its aerodrome traffic zone are properly maintained and safe for use by an aircraft;
 - (iv) the physical characteristics of the aerodrome and its surroundings, and
 - (v) the aerodrome manual submitted pursuant to paragraph (8), that the applicant is competent and the aerodrome is safe for use by an aircraft,

grant the application and issue the licence subject to such terms and conditions as he may determine.

(3) A licence issued under paragraph (2) shall remain in force for the period specified in the licence and may be renewed for such further period, as the Authority may determine, on being satisfied that the holder is competent and the aerodrome is safe for use by aircraft.

(3A) An application for the renewal of a licence shall be made to the Authority within 2 months of the expiry of the licence.

(3B) Where the Authority grants an application made under paragraph (3A), it shall renew the licence.

(3C) Every holder of a valid licence shall, not later than the fifth day of every month, pay the monthly fee, specified in the Second Schedule, with respect to passengers arriving at the aerodrome in the preceding month.

(4) The Minister may issue a licence under paragraph (2) as a licence for public use.

(5) Where a licence for public use is issued, the aerodrome shall be made available, at all times when it is available for the take-off and landing of an aircraft, to all users on equal terms and conditions.

(6) The holder of a licence issued under this regulation shall –

- (a) at the request of any interested person, furnish information concerning the terms of the licence; and
- (b) in the case of a licence for public use, cause to be notified the times during which the aerodrome will be available for the take-off and landing of an aircraft engaged on flights for the purpose of public transport of passengers or instruction in flying.

(7) No person shall operate an aerodrome in Mauritius unless he –

- (a) holds a licence to that effect; and
- (b) operates the aerodrome in accordance with the terms and conditions of the licence.

(8) On making an application for an aerodrome licence, the applicant shall submit to the Authority for approval –

- (a) an aerodrome manual;
- (b) a safety management system manual;
- (c) an aerodrome emergency manual; and
- (d) an airside driving manual,

for that aerodrome.

(9) An aerodrome manual, required pursuant to paragraph (8), shall contain all such information and instructions as may be necessary to enable the aerodrome operating staff to perform their duties, including all such particulars and information as are specified in Annexes 4, 14 and 15 to the Convention.

(9A) The applicant shall, for every submission made under paragraph (8), pay to the Authority the appropriate fee specified in the Second Schedule.

(10) Every holder of an aerodrome licence shall –

- (a) furnish to the Authority any amendment or addition to the aerodrome manual before they come into effect;
- (b) make such amendments or addition to the aerodrome manual, as the Authority may require, for the purpose of ensuring the safe operation of an aircraft or the safety of air navigation;
- (c) maintain the aerodrome manual and make such amendments as may be necessary for the purpose of keeping its contents up to date; and
- (d) make available, to every member of the aerodrome operating staff, a copy of the aerodrome manual, or of every part which is relevant to his duties.

(11) In this regulation –

“aerodrome operating staff” –

- (a) means every person, whether or not being the holder of the aerodrome licence; and
- (b) includes any person, whether or not employed by the holder of the aerodrome licence, whose duties –
 - (i) are to ensure that the aerodrome and airspace, within which its visual traffic pattern is normally contained, are safe for an aircraft; or

(ii) require them to have access to the aerodrome manoeuvring area or apron.

[Reg. 103 amended by reg. 36 of GN 17 of 2010 w.e.f. 1 February 2010.]

103A. Approval of instructors, training courses and examiners

(1) (a) No instructor shall provide a training course or an instruction, for the purpose of regulation 103, unless he and the training course or instruction obtain the approval of the Authority.

(b) No person shall conduct an examination or test, for the purpose of regulation 103, unless he has obtained the approval of the Authority to act as examiner.

(2) Every person who wishes to –

(a) provide a training course or an instruction; or

(b) conduct an examination or test,

relating to civil aviation, as the case may be, shall make an application to the Authority.

(3) Where the Authority grants the application, it shall issue a written approval in respect of –

(a) the instructor and the training course or instruction; or

(b) the examiner,

as the case may be.

(4) Where the written approval granted under paragraph (3) is in relation to a training course or an instruction, the Authority shall specify the title of the training course or instruction, as the case may be, on the written approval.

(5) The holder of an approval in relation to a training course or an instruction shall not provide an additional training course or instruction unless that training course or instruction has been approved by the Authority.

(6) Where the holder of an approval referred to in paragraph (5) wishes to provide an additional training course or instruction, he shall make an application to the Authority.

(7) An approval, other than an approval in relation to a training course or instruction, issued under this regulation shall be valid for a period of 12 months from the date of issue and may be renewed.

(8) An application for the renewal of an approval shall be made to the Authority within one month of the expiry of the approval.

(9) Where the Authority grants the application made under paragraph (6) or (8), it shall issue a written approval.

[Reg. 103A inserted by reg. 37 of GN 17 of 2010 w.e.f. 1 February 2010.]

103B. Inspection of aerodrome

(1) The Authority may, for safety reasons or in the public interest, or at the request of the holder of an aerodrome licence, inspect an aerodrome or carry out a follow-up or partial audit of the aerodrome.

(2) Where the Authority inspects an aerodrome under paragraph (1), the holder of the aerodrome licence shall pay to the Authority the appropriate fee specified in the Second Schedule.

[Reg. 103B inserted by reg. 37 of GN 17 of 2010 w.e.f. 1 February 2010.]

103C. Helipad

(1) No person shall use or cause to be used a helipad at any place in Mauritius unless the helipad is approved by the Authority.

(2) An application for the use of a helipad shall be made to the Authority.

(3) Where the Authority, having regard to –

(a) the arrangements that the applicant proposes to make; and

(b) the physical characteristics of the helipad and its surroundings,

is satisfied that the helipad is properly maintained and safe for use by an aircraft, it may grant the application and issue a written approval.

(4) An approval given by the Authority under this regulation shall be valid for a period of 12 months from the date of issue and may be renewed.

(5) An application for the renewal of an approval shall be made to the Authority within 3 months of the expiry of the approval.

(6) Where the Authority grants an application made under paragraph (5), it shall renew the approval.

[Reg. 103C inserted by reg. 37 of GN 17 of 2010 w.e.f. 1 February 2010.]

103D. Airside vehicle permit

(1) Subject to paragraph (7), no person shall –

- (a) drive a motor vehicle on the airside; or
- (b) permit or employ any person to drive a motor vehicle on the airside,

unless an airside vehicle permit is issued by the Authority in respect of that motor vehicle.

(2) An application for an airside vehicle permit shall be –

- (a) made to the Authority;
- (b) accompanied by –
 - (i) the following particulars with respect to the motor vehicle –
 - (A) the name of the owner;
 - (B) the postal address of the owner;
 - (C) the description of the type of motor vehicle; and
 - (D) the type and colour of body of the motor vehicle; and

(ii) a copy of –

- (A) the policy of insurance in relation to the use of the motor vehicle by the applicant or by other persons, on his order or permission, in respect of third party risks;
- (B) the apron worthiness certificate in relation to the use of the motor vehicle issued by a licensed aerodrome operator; and
- (C) the maintenance certificate of the motor vehicle issued by a person recognised by the Authority.

(3) Where the Authority grants the application, it shall issue to the applicant an airside vehicle permit.

(4) An airside vehicle permit granted under this regulation shall be valid for a period of 12 months from the date of issue and may be renewed.

(5) An application for the renewal of an airside vehicle permit shall be –

- (a) made to the Authority within 3 months of the expiry of the permit; and
- (b) accompanied by –
 - (i) the particulars referred to in paragraph (2)(b)(i);
 - (ii) the documents referred to in paragraph (2)(b)(ii); and
 - (iii) the appropriate fee specified in the Sixteenth Schedule.

(6) Where the Authority grants an application made under paragraph (5), it shall renew the airside vehicle permit.

(7) (a) The Authority may, in relation to such class of persons as it may determine, exempt every person of that class from complying with this regulation.

(b) An exemption granted by the Authority under subparagraph (a) may be subject to such terms and conditions as it may determine.

[Reg. 103D inserted by reg. 37 of GN 17 of 2010 w.e.f. 1 February 2010.]

103E. Airside vehicle licence

(1) Subject to paragraph (8), no person shall –

- (a) drive a motor vehicle; or
- (b) permit or employ any person to drive a motor vehicle,

on the airside of an aerodrome, unless he is the holder of an airside vehicle licence and –

- (i) a valid driving licence, issued under the Road Traffic Act, authorising him to drive a motor vehicle of that class or description;
- (ii) a training certificate, issued by a licensed aerodrome operator, certifying that he has the required knowledge and competence to drive a motor vehicle on the airside of an aerodrome; and
- (iii) an aviation security identification card issued under the Civil Aviation (Security) Regulations 2008.

(2) An application for an airside vehicle licence shall be made to the Authority.

(3) Where the Authority grants an application made under paragraph (2), it shall issue to the applicant an airside vehicle licence.

(4) An airside vehicle licence granted under this regulation shall be valid for a period of 12 months from the date of issue and may be renewed.

(5) An application for the renewal of an airside vehicle licence under this regulation shall be –

- (a) made to the Authority within one month of the expiry of the licence; and
- (b) accompanied by a training certificate, issued by a licensed aerodrome operator, certifying that he has the required knowledge and competence to drive a motor vehicle on the airside of an aerodrome.

(6) Where the Authority grants an application made under paragraph (5), it shall renew the airside vehicle permit.

(7) The Authority shall not grant an application for renewal made under paragraph (5) unless the applicant holds a valid driving licence and an aviation security identification card referred to in paragraph (1).

(8) (a) The Authority may, in relation to such class of persons as it may determine, exempt every person of that class from complying with this regulation.

(b) An exemption granted by the Authority under subparagraph (a) may be subject to such terms and conditions as it may determine.

[Reg. 103E inserted by reg. 37 of GN 17 of 2010 w.e.f. 1 February 2010.]

103F. Passenger boarding bridge

(1) No person shall –

- (a) operate a passenger boarding bridge; or
- (b) permit any person to operate a passenger boarding bridge,

at an aerodrome, unless the passenger boarding bridge is approved by the Authority.

(2) An application for the approval of a passenger boarding bridge shall be –

- (a) made to the Authority; and
- (b) accompanied by a certificate, issued by the manufacturer of the passenger boarding bridge, certifying that it is fit and safe to be used.

(3) Where the Authority grants an application made under paragraph (2), it shall issue a written approval.

(4) An approval granted under paragraph (3) shall be valid for a period of 12 months from the date of issue and may be renewed.

(5) An application for the renewal of an approval granted under this regulation shall be –

- (a) made to the Authority within 3 months of the expiry of the approval; and
- (b) accompanied by –
 - (i) a maintenance certificate issued by a licensed aerodrome operator; and
 - (ii) the appropriate fee specified in the Second Schedule.

(6) Where the Authority grants an application made under paragraph (5), it shall renew the approval.

[Reg. 103F inserted by reg. 37 of GN 17 of 2010 w.e.f. 1 February 2010.]

103G. Passenger boarding bridge operator permit

- (1) No person shall –
 - (a) operate a passenger boarding bridge; or
 - (b) permit any person to operate a passenger boarding bridge,

at an aerodrome, unless the person holds a passenger boarding bridge operator permit.

- (2) An application for a passenger boarding bridge operator permit shall be –
 - (a) made by the employer on behalf of the employee he wishes to appoint as a passenger boarding bridge operator; and
 - (b) made to the Authority.

(3) Where the Authority grants an application made under paragraph (2), it shall issue to the applicant a passenger boarding bridge operator permit.

(4) Every passenger boarding bridge operator shall, at all times, carry his passenger boarding bridge operator permit.

(5) Subject to paragraph (6), a passenger boarding bridge operator permit shall be valid for a period of 12 months from the date of issue and may be renewed.

(6) A passenger boarding bridge operator permit shall cease to be valid where the employer of the holder of the passenger boarding bridge operator permit –

- (a) is no longer using his services; or
- (b) has ceased his business.

(7) Where a passenger boarding bridge operator permit ceases to be valid, its holder shall forthwith surrender the permit to the Authority.

(8) An application for the renewal of a passenger boarding bridge operator permit shall, within one month of the expiry of the permit, be made to the Authority.

(9) Where the Authority grants an application made under paragraph (8), it shall renew the permit.

[Reg. 103G inserted by reg. 37 of GN 17 of 2010 w.e.f. 1 February 2010.]

104. Radio equipment at aerodrome

(1) This regulation shall apply to any person approved under regulation 92 for providing air traffic control service at an aerodrome at which an air traffic control service is not provided by the Authority.

(2) No person shall cause or permit any radio communication, radar or radio navigation equipment to be used to facilitate an aircraft's approach to land, or landing, at an aerodrome unless the equipment is –

- (a) approved by the Authority as suitable for the service to be provided;
- (b) installed and maintained in a manner approved by the Authority; and
- (c) flight checked, overhauled, repaired or modified by, or under the supervision of, a person approved by the Authority.

105. Records at aerodrome

(1) This regulation shall apply to an aerodrome to which regulation 104 applies.

(2) Every air traffic control service provider shall –

- (a) in respect of every installation of radio communication, radar or radio navigation equipment provided by him and used to facilitate an aircraft's approach to land, or landing, at the aerodrome, keep a written record of particulars of functional tests and flight checks of the equipment as well as particulars of any overhaul, repair, replacement or modification of the equipment;
- (b) preserve the record for a period of one year or such longer period as the Authority may,

in a particular case, direct; and

(c) on demand, produce the record to an authorised person.

(3) An air traffic control service provider shall, where the aerodrome is provided with –

(a) two-way radio communication equipment with an aircraft; and

(b) radar equipment or very high frequency direction finding apparatus for the purpose of providing holding aid, let-down aid or approach aid,

provide, at the aerodrome, an apparatus which is capable of recording the content of any radio message or signal transmitted to an aircraft, alone or in common with other aircraft, or received from an aircraft, by the air traffic control unit at the aerodrome.

(4) The apparatus provided under paragraph (3) shall be –

(a) of a type approved by the Authority, in relation to the aerodrome;

(b) installed in a manner approved by the Authority;

(c) at all times maintained in a serviceable condition; and

(d) in use at all times when any navigation service is being provided by the air traffic control unit, at the aerodrome, to any aircraft.

(5) An air traffic control service provider shall ensure that every record made by an apparatus under paragraph (3) includes –

(a) the date on which the record was made;

(b) a means of identifying –

(i) the person at the aerodrome by whom the message or signal was transmitted or received;

(ii) the frequency on which the message or signal was transmitted or received, and the aircraft to which it was transmitted or from which it was received; and

(iii) the time at which every message or signal was transmitted or received; and

(c) where applicable, the time at which the radio station at the aerodrome opened or closed within the period covered by every record.

(6) Where the apparatus under paragraph (3) ceases to be capable of recording the matters required under this regulation to be included in the record, the air traffic control service provider shall ensure that those matters are recorded in writing.

(7) An air traffic control service provider shall –

(a) preserve the records kept under this regulation for a period of 30 days from the date on which the message or signal was recorded or such longer period as the Authority may, in a particular case, direct; and

(b) on demand, produce that record to an authorised person.

(8) Where a person required under this regulation to preserve any record, by reason of his being an air traffic control service provider, ceases to provide the service, that record shall –

(a) subject to subparagraph (b), continue to be preserved by him, or, in the event of his death, by his personal representative, as if he had not ceased to be such service provider;

(b) where another person becomes such service provider, be delivered, on demand, to that other person.

(9) A person to whom a record has been delivered under paragraph (8) shall deal with the record as if it had been kept or preserved by him in the first instance.

106. Charges at aerodromes licensed for public use

(1) Every holder of a licence in respect of an aerodrome for public use shall submit to the Minister, for approval, any charge in relation to the use of the aerodrome or the provision of any service at the aerodrome in connection with any aircraft, including provisions for the safety, efficiency

or regularity of air navigation.

(2) On receipt of a request for approval under paragraph (1), the Minister may, in relation to any aerodrome in respect of which a licence for public use has been granted, approve the charge to be made, and the conditions to be complied with, in relation to the use of the aerodrome or the provision of a service at the aerodrome in connection with any aircraft, including provisions for the safety, efficiency or regularity of air navigation.

(3) The holder of a licence in respect of an aerodrome in relation to which the Minister has given an approval under paragraph (2) and the air traffic control service provider situated at the aerodrome shall –

- (a) cause particulars of any approved charge to be kept exhibited at the aerodrome in such a place and manner as to be readily available for the information of any interested person; and
- (b) not cause or permit any charge to be made in contravention of what is approved under paragraph (2).

(4) The holder of a licence in respect of an aerodrome for public use, or an air traffic control service provider, shall, when required by the Minister, furnish to him such particulars as he may require of the charge made by the holder for the use of the aerodrome or any facility provided at the aerodrome for the safety, efficiency or regularity of air navigation.

107. Use of aerodrome by aircraft of Contracting State

(1) Every person in charge of an aerodrome in respect of which a licence for public use has been issued and is open to international air traffic, shall cause the aerodrome to be available for use by any aircraft registered in a Contracting State on the same terms and conditions as by an aircraft registered in Mauritius.

(2) The provider of air traffic control service at an aerodrome in respect of which a licence for public use has been issued and is open to international air traffic, shall provide the air traffic control service and navigation facilities to any aircraft registered in a Contracting State on the same terms and conditions as to an aircraft registered in Mauritius.

108. Aeronautical ground lights

(1) Except with the permission of the Authority and in accordance with any condition subject to which the permission may be granted, no person shall establish, maintain or alter the character of –

- (a) an aeronautical beacon within Mauritius; or
- (b) any aeronautical ground light, other than an aeronautical beacon, at an aerodrome licensed under these regulations, or which forms part of the lighting system, for use by an aircraft taking off from, or landing at, such an aerodrome.

(2) Where an aeronautical beacon is, or may be, visible from the waters within an area of a general lighthouse authority, the Authority shall not give its permission under this regulation except with the consent of that lighthouse authority.

(2A) Every permission given by the Authority under this regulation shall be subject to –

- (a) the payment of the appropriate fee specified in the Second Schedule; and
- (b) such terms and conditions as the Authority may determine.

(3) No person shall damage, or interfere with, an aeronautical ground light established and maintained by, or with the permission of, the Authority.

[Reg. 108 amended by reg. 38 of GN 17 of 2010 w.e.f. 1 February 2010.]

109. Dangerous lights

(1) No person shall exhibit any light which –

- (a) by reason of its glare, is likely to endanger an aircraft taking off from, or landing, at an aerodrome; or
- (b) by reason of the likelihood of it being mistaken for an aeronautical ground light, is likely to endanger an aircraft.

(2) Where it appears to the Authority that a light is exhibited in contravention of paragraph (1), the Authority may cause a notice to be served on the person who is the occupier of the place where the light is exhibited or has charge of the light, directing that person, within a reasonable time to be specified in the notice, to take such steps as may be specified in the notice with a view to extinguish or screen the light, or prevent for the future, the exhibition of any light which may similarly endanger an aircraft.

(3) A notice under paragraph (2) shall be served personally, by post or by affixing it in some conspicuous place near the light to which it relates.

(4) In the case of a light which is, or may be, visible from any waters within the area of a general lighthouse authority, the powers of the Authority under this regulation shall not be exercised except with the consent of that lighthouse authority.

110. Customs airports

The Minister may, with the concurrence of the Director-General of the Mauritius Revenue Authority, and subject to such terms and conditions as they may determine, designate an aerodrome to be a place for the landing and departure of an aircraft for the purpose of any enactment relating to customs and excise.

[Reg. 110 amended by reg. 39 of GN 17 of 2010 w.e.f. 1 February 2010.]

111. Aviation fuel installation at aerodrome

(1) Subject to paragraph (2), a person who has the management of any aviation fuel installation on an aerodrome shall not cause or permit any fuel to be delivered to that installation, or from it to an aircraft, unless –

- (a) in the case of aviation fuel delivered to the installation, he is satisfied that –
 - (i) the installation is capable of storing and dispensing the fuel so as not to render it unfit for use in aircraft;
 - (ii) the installation is marked in a manner appropriate to the grade of fuel stored or, if different grades are stored in different parts, every part is marked accordingly; and
 - (iii) where delivery to the installation is made from a vehicle or vessel, the fuel has been sampled and is of a grade appropriate to that installation and is fit for use in an aircraft;
- (b) where aviation fuel is delivered from the installation to an aircraft, he is satisfied, as a result of sampling, that the fuel is fit for use in an aircraft; and
- (c) the aviation fuel installation has been approved by the Authority.

(2) Paragraph (1) shall not apply in respect of fuel which has been removed from an aircraft and is intended for use in another aircraft operated by the same operator.

(2A) Any person who wishes to obtain the approval of the Authority for the management of an aviation fuel installation at an aerodrome in Mauritius shall make an application to the Authority.

(2B) Every application made under paragraph (2A) shall be for a period of not less than 6 months and not more than 12 months.

(2C) Where the Authority grants an application made under paragraph (2A), it shall issue a written approval to the applicant for such period as may be specified in the approval.

(2D) An approval issued under paragraph (2C) shall be valid for such period as may be determined by the Authority and may be renewed.

(2E) An application for renewal of an approval shall be made to the Authority within one month of the expiry of the approval.

(3) A person to whom paragraph (1) applies shall keep a written record in respect of every installation of which he has the management.

(4) A record kept under paragraph (3) shall include particulars of –

- (a) the grade and quantity of aviation fuel delivered and the date of delivery;
- (b) all samples of the aviation fuel taken and of the results of tests of those samples; and

(c) the maintenance and cleaning of the installation.

(5) A record referred to in paragraph (3) shall –

(a) be preserved for a period of 12 months or such longer period as the Authority may direct; and

(b) on demand, be produced to an authorised person.

(6) No person shall cause or permit aviation fuel to be delivered to an aircraft where he knows, or has reason to believe, that the aviation fuel is not fit for use in an aircraft.

(7) Where it appears to the Authority, or an authorised person, that aviation fuel is likely to be delivered in contravention of this regulation, the Authority, or the authorised person, may direct the person having the management of the installation not to deliver the fuel from that installation.

(8) The Authority may, at any reasonable time, conduct an inspection of the fuel installation and the records kept under paragraphs (3) and (4), to ensure compliance with this regulation.

(9) –

[Reg. 111 amended by reg. 40 of GN 17 of 2010 w.e.f. 1 February 2010.]

111A. Ground handling service

(1) No person shall provide a ground handling service at an aerodrome unless he has obtained the written approval of the Authority.

(2) Any person who wishes to provide a ground handling service shall make an application to the Authority.

(3) Every application made under paragraph (2) shall contain the types of ground handling services which the applicant proposes to provide.

(4) Where the Authority grants an application made under paragraph (2), it shall issue a written approval to the applicant.

(5) An approval granted under paragraph (4) shall be valid for a period of 12 months from the date of issue and may be renewed.

(6) An application for the renewal of an approval shall be made to the Authority within one month of the expiry of the approval.

(7) Where the Authority grants an application made under paragraph (6), it shall renew the approval.

[Reg. 111A inserted by reg. 41 of GN 17 of 2010 w.e.f. 1 February 2010.]

PART XI – AIRCRAFT ACCIDENT INVESTIGATION

112. Application

(1) This Part shall apply to an accident which arises out of, or in the course of, air navigation and involves a civil aircraft.

(2) Any notice or other document required or authorised by this Part to be served on or given to any person may be served or given by –

(a) delivering it to that person;

(b) leaving it at his usual or last known residence or place of business in Mauritius or elsewhere;

(c) sending it to him by post at that address; or

(d) sending it to him at that address by telex, by facsimile transmission or other similar means which produces a document containing a text of the communication, in which event the document shall be regarded as served when it is received.

113. Requirement of notification

(1) On the occurrence of an accident, the commander of the aircraft involved in the accident or, if he is killed or incapacitated, the owner, operator, hirer or other person on whose behalf he was in command of the aircraft, as the case may be, shall notify the Authority of the accident with a minimum of delay and by the most suitable and quickest means available and, in any case, not later than 24

hours after the occurrence of the accident.

(2) On receipt of a notification under paragraph (1), the Authority shall, in the case of an accident occurring in or over Mauritius, forthwith transmit a copy of the notification to the Commissioner of Police.

(3) The notification of an accident under this regulation shall commence with the identifying abbreviation 'ACCID' and, subject to paragraph (4), shall contain the following information –

- (a) the type, model, nationality and registration marks of the aircraft;
- (b) the name of the owner, operator, hirer or other person on whose behalf the aircraft was being flown;
- (c) the name of the commander of the aircraft;
- (d) the date and time of the accident;
- (e) the last point of departure and point of intended landing of the aircraft;
- (f) the position of the aircraft with reference to some easily defined geographical point;
- (g) the number of persons on board the aircraft at the time of the accident;
- (h) the number of persons on board the aircraft who are killed or seriously injured as a result of the accident;
- (i) the number of persons killed or seriously injured elsewhere than on the aircraft;
- (j) the nature of the accident and the extent of damage to the aircraft;
- (k) the nature and purpose of the flight; and
- (l) the physical characteristics of the accident area.

(4) Where, at the time of dispatch of a notification under this regulation, any information required under paragraph (3) is not readily available –

- (a) the dispatch of the notification shall not be delayed on that account; and
- (b) the information shall be submitted as soon as reasonably practicable.

114. Removal of damaged aircraft

(1) Subject to paragraph (2), where an accident occurs in or over Mauritius, no person shall, except with the permission of the Authority, have access to the aircraft involved in the accident or remove, or otherwise interfere with, it.

(2) Where an aircraft has been involved in an accident, the aircraft or any of its parts or contents may be removed or interfered with so far as may be necessary for the purpose of –

- (a) extricating any person or animal, whether dead or alive;
- (b) preventing the destruction of the aircraft or its content by fire or any other cause;
- (c) preventing any damage or obstruction to the public or to air navigation or to other means of transport; or
- (d) in the case of an aircraft which has landed on water, bringing it to a place of safety.

(3) Where an aircraft has been involved in an accident, its contents, including the personal baggage of passengers and members of the flight crew, shall not be removed from the aircraft except under the supervision of the Authority, a customs officer, a police officer and –

- (a) in the case of cargo, a health and an agricultural officer;
- (b) in the case of mail, a postal officer.

(4) The Authority may authorise any person to take measures for the preservation of any aircraft involved in an accident and may, for that purpose, authorise him to have access to the aircraft with a view to examine, or otherwise deal with, it.

(5) An operator shall ensure, to the extent possible, in the event the aircraft becomes involved in an accident, the preservation of all flight recorder records and, if necessary, the associated flight recorders and their retention, in safe custody, pending action in accordance with paragraph (4).

115. Duty to carry out investigations

(1) On receipt of a notification of an accident under regulation 113, or on its own initiative, the Authority may carry out, or appoint an Inspector to carry out, an investigation into the causes and circumstances of any accident, in accordance with Chapter 5 of Annex 13 to the Convention.

(2) Where an investigation is to be carried out under paragraph (1), the Authority shall, in such manner as it may determine, give public notice to the effect that an investigation is due to take place and that any person who desires to make representations concerning the causes or circumstances of the accident may do so in writing within a time to be specified in the notice.

116. Powers in relation to investigations

For the purpose of an investigation under regulation 115, the Authority or an Inspector may –

- (a) summon and examine any person, whether on oath or otherwise;
- (b) require any person to answer any question or furnish any information;
- (c) require any person to make and to sign a declaration regarding the true nature of a statement made by him;
- (d) demand the production of any book, paper, document or article pending completion of the investigation;
- (e) have access to and examine –
 - (i) an aircraft involved in the accident;
 - (ii) the place where the accident occurred; or
 - (iii) any other place or building, the examination of which appears to the Authority or the Inspector to be necessary;
- (f) examine, remove, test, take measures for the preservation of, or otherwise deal with, the aircraft or anything contained in it, including the flight recorders and any other recording; and
- (g) take such measures as may be necessary for the preservation of evidence.

117. Conduct of investigations

(1) The investigation of an accident under regulation 115 shall, unless the Minister directs otherwise, be held in private.

(2) In determining the circumstances and causes of an accident, the Authority or an Inspector, shall have regard to the principle that an investigation is carried out with a view to avoid accidents in the future, and not for apportioning blame or liability.

118. Report of investigations

(1) Where an investigation of an accident has been carried out under regulation 115, a report shall be forwarded –

- (a) in the case of an investigation carried out by the Authority, to the Minister; and
- (b) in the case of an investigation carried out by an Inspector, to the Authority who shall transmit it to the Minister with such comments as it may think fit to make on the report.

(2) A report under paragraph (1) shall contain –

- (a) all relevant facts with regard to the accident;
- (b) the conclusions reached with regard to the circumstances and causes of the accident; and
- (c) any observation or recommendation which the person making the request thinks fit and proper to make with a view to preservation of life and avoidance of similar accidents in the future.

119. Committee of inquiry

(1) Notwithstanding this Part, the Minister may appoint a Committee of Inquiry, consisting of 2 or more persons, to hold an inquiry into any accident and that Committee shall, for the purposes of the inquiry, have all the powers of the Authority or an Inspector under regulation 116.

(2) Unless the Minister directs otherwise, a Committee of Inquiry shall sit in private.

(3) Where a Committee of Inquiry has been appointed, the Minister shall give public notice to the effect that an inquiry is due to take place and that any person who desires to make representations concerning the circumstances or causes of the accident may do so in writing within a time to be specified in the notice.

(4) The Committee of Inquiry shall make a report to the Minister, stating all relevant facts with regard to the accident and its conclusions with regard to the circumstances and causes of the accident, together with any observation or recommendation which it thinks fit to make with a view to preservation of life and avoidance of similar accidents in the future.

(5) Where the Minister has appointed a Committee of Inquiry to inquire into an accident, the Authority or an Inspector shall not, unless the Minister otherwise directs, carry out any investigation into the same accident.

120. Report to Minister

(1) On receipt of a report under regulation 118 or 119, the Minister may, subject to paragraphs (2) and (3), cause the report to be published.

(2) Where it is likely that the report may adversely affect the reputation of any person, the Minister shall not cause any part of that report to be published unless –

- (a) he has served on that person a written notice containing particulars of the relevant parts of the report; and
- (b) having regard to any written representation made by, or on behalf of, that person within 28 days of service of the notice, he is satisfied that it would not be contrary to the public interest to do so.

(3) The Minister may, at any stage before or after the publication of a report –

- (a) direct a rehearing of the investigation or inquiry; or
- (b) appoint a suitably qualified person to review the findings and conclusions of the investigation or inquiry and make appropriate recommendations.

(4) The rehearing shall, unless the Minister decides otherwise, be –

- (a) held in private; and
- (b) conducted by the same person who, in the first instance, carried out the investigation and heard the inquiry.

121. Obstruction of proceedings

No person shall obstruct or impede, or without reasonable excuse, fail to comply with any summons, direction or requisition of a Committee of Inquiry, the Authority, an Inspector or any other person acting in the performance of any function conferred under this Part.

122. Accidents to aircraft registered in a foreign state

(1) Where an investigation or any inquiry under this Part relates to an accident which has occurred in or over Mauritius, involving an aircraft registered in a State other than Mauritius, an accredited representative of the State of the operator, the State of design, the State of manufacture and any other State which has, on request, furnished information in connection with the accident, may participate in the investigation or inquiry, as the case may be.

(2) An accredited representative referred to in paragraph (1) may be accompanied by such technical or other advisers as may be considered necessary by the State by which he is appointed.

123. Release of aircraft

On completion of an investigation or inquiry into an accident to which regulation 122 applies, the Authority shall release the aircraft and its contents or parts to any person duly designated by the State of registry where the aircraft is registered.

124. Report in respect of foreign aircraft

Subject to the approval of the Minister, the Authority shall, after the close of an investigation or

inquiry relating to a foreign aircraft, transmit to the state of registry where the aircraft is registered a report containing the findings of the Authority, Inspector or Committee of Inquiry, as the case may be, together with a summary of evidence and other essential information on which the findings were based.

PART XII – MISCELLANEOUS

124A. Medical examiner

(1) No medical practitioner shall act or hold himself out as a medical examiner for the purpose of these regulations unless he is registered with the Authority.

(2) Every medical practitioner who wishes to be a medical examiner for the purpose of these regulations shall make an application for registration to the Authority.

(3) Where the Authority grants the application, it shall register the applicant subject to such conditions as it may determine.

(4) Subject to paragraph (8), no medical practitioner shall be registered with the Authority as a medical examiner, unless –

(a) he is registered or is exempted from registration, under the Medical Council Act, to practise medicine, or is entitled to practise medicine under the law of a Contracting State; and

(b) he has knowledge and competence relating to aviation medicine.

(5) A registration made under this regulation shall be valid for a period of 3 years from the date of issue and may be renewed.

(6) An application for the renewal of a registration shall be made to the Authority within 3 months of the expiry of the registration.

(7) Where a medical examiner continues to comply with this regulation and any condition imposed under paragraph (3), the Authority may renew the registration.

(8) Where a medical practitioner is beyond the age of 70, the Authority shall not –

(a) register him as a medical examiner; or

(b) renew his registration as a medical examiner.

[Reg. 124A inserted by reg. 42 of GN 17 of 2010 w.e.f. 1 February 2010.]

125. Carriage in aircraft not registered in Mauritius

Where an aircraft registered in a Contracting or in a foreign State carries passengers or cargo for hire or reward, it shall not take on board or discharge the passengers or cargo in Mauritius except with the permission of the Minister granted to the operator, charterer of the aircraft or Government of the State in which the aircraft is registered.

126. Filing and approval of tariffs

(1) Where a permission granted under regulation 125 contains a tariff provision, the operator or charterer of the aircraft concerned shall file with the Minister the tariff which it proposes to apply on flights to which the permission relates and the Minister shall consider the proposed tariff and may, if he may determine, approve or disapprove it.

(2) In this regulation –

“tariff provision” means a condition as to –

(a) the price to be charged for the carriage of passengers, baggage or cargo on flights to which a permission granted under regulation 125 relates;

(b) any additional good, service or other benefit to be provided in connection with such carriage;

(c) the price, if any, to be charged for any such additional good, service or benefit; or

(d) the commission, or rates of commission, to be paid in relation to the carriage of passengers, baggage or cargo and includes any condition as to the applicability of any such price, the provision of any such good, service or benefit or the payment of any

such commission or of commission at any such rate.

127. Restriction with respect to aerial photography and survey from aircraft registered outside Mauritius

Except with the written authorisation of the Minister, an aircraft registered in a Contracting or foreign State shall not fly over Mauritius for the purpose of aerial photography or aerial survey.

128. Mandatory reporting

- (1) Where a reportable occurrence takes place, every person who –
 - (a) is the operator or commander of a public transport aircraft which is registered in Mauritius and the maximum total authorised mass of which exceeds 2,300 kilogrammes;
 - (b) carries on business of manufacturing, repairing or overhauling an aircraft, or any equipment or part of an aircraft referred to in subparagraph (a);
 - (c) signs a certificate of maintenance or compliance in respect of an aircraft referred to in subparagraph (a), or any equipment or part of that aircraft;
 - (d) performs the function of an air traffic controller; or
 - (e) is the licence holder or manager of a licensed aerodrome,

shall submit a report in accordance with paragraph 14 of the Seventh Schedule.

(2) This regulation shall not require a person to report any occurrence which he has reason to believe has been, or will be, reported by another person to the Authority under this regulation.

(3) No person shall, under this regulation, make a report which he knows, or has reason to believe, to be false in any material particular.

(4) Subject to paragraph (5) and to regulation 84, the operator of an aircraft shall, if he has reason to believe that a report has been, or will be, made under this regulation, preserve any data from a flight data recorder relevant to the reportable occurrence for 14 days from the date on which a report is made to the Authority or for such longer period as the Authority may direct.

(5) The operator of an aircraft may erase the recording from a flight data recorder if the aircraft is outside Mauritius and it is not reasonably practicable to preserve the record until the aircraft reaches Mauritius.

129. Power to prevent aircraft flying

- (1) Where, in relation to an aircraft which is intended or likely to be flown, it appears that –
 - (a) there is likely to be a breach of regulation 6, 10, 11, 14, 30, 31, 32, 44, 60, 63, 64 or 65;
 - (b) the flight is likely to contravene these regulations and be a cause of danger to any person or property, whether or not on the aircraft; or
 - (c) the aircraft is in a condition unfit for the flight,

the Authority, or an authorised person, may direct the operator or the commander of the aircraft not to permit the aircraft to make that particular flight or any other flight of such description as the Authority, or the authorised person, may specify.

(2) Where it appears to the Minister, or an authorised person, that an aircraft is intended or likely to be flown in circumstances amounting to a breach of regulation 98 or 99, the Minister, or the authorised person, may direct the operator or the commander of the aircraft not to permit the aircraft to make that particular flight or any other flight of such description as the Minister, or the authorised person, may specify.

(3) In the exercise of the powers conferred under this regulation, the Authority, the Minister or an authorised person, as the case may be, may –

- (a) enter and inspect an aircraft; and
- (b) take such steps as are necessary to detain the aircraft.

130. Right of access to aerodrome and other places

The Authority and any authorised person shall, at all reasonable times, have access to any aerodrome, or other place where an aircraft has landed, for the purpose of –

- (a) inspecting or detaining an aircraft;
- (b) in the case of an aerodrome, inspecting the aerodrome;
- (c) inspecting any building or place from which an air traffic control service is being provided or where any air traffic service equipment requiring approval under regulation 104 is situated;
- (d) inspecting any equipment used or intended to be used in connection with the provision of a service to an aircraft in flight or on the ground; or
- (e) inspecting any document or record which it or he has power to demand under these regulations.

131. Powers and duties of authorised persons

(1) The Authority, or an authorised person, shall have the power to carry out audits or, subject to any other enactment, surveillance to require any person to produce a document or any other article for the purpose of detecting any contravention of these regulations.

(2) Any person who, having been required to produce a document or other article, without lawful cause makes a statement that is false in any material particular, or fails to produce any document or other article which is in his possession or control or to which he has access, shall commit an offence.

(3) Where it appears to the Authority that an aircraft is intended or likely to be flown in circumstances that the flight would be in contravention with these regulations, or it would be a cause of danger to persons in the aircraft or to persons or property on the ground, it may detain the aircraft or take such other action as may be necessary for the purpose of inspecting the aircraft, and where appropriate causing the intended flight to be investigated.

(4) Where an aircraft has been detained pursuant to paragraph (3) above, such aircraft shall not be operated until the Authority gives its approval, on being satisfied that these regulations are being complied with or until such modifications or repairs, as the Authority considers necessary to render the aircraft fit for flight, have been effected.

(5) For the purpose of exercising his powers under these regulations, an authorised person shall be issued with and carry at all times a means of identification.

132. Application of regulations to Mauritian controlled aircraft not registered in Mauritius.

The Authority may, in relation to an aircraft not registered in Mauritius but which is under the management of a qualified person, direct that such provisions of these regulations as are considered necessary for ensuring the safety of aircraft operations, shall have effect as if that aircraft were registered in Mauritius.

133. Article 83 *bis* of Convention

(1) Subject to paragraph (5), where an aircraft is registered in a Contracting and foreign State but is operated, pursuant to an agreement for the lease, charter or interchange of the aircraft or any similar arrangement, by an operator who has his principal place of business or, his permanent residence in Mauritius, the Government may enter into an agreement with the Government of the Contracting State in relation to the transfer of functions and duties pursuant to Article 83 *bis* of the Convention.

(2) Where an agreement has been entered into under paragraph (1), such provisions of these regulations which are relevant to the functions and duties transferred by the Contracting State to the Government shall be applicable to that aircraft as if it were registered in Mauritius.

(3) Subject to paragraph (5), where an aircraft is registered in Mauritius but is operated, pursuant to an agreement for lease, charter or interchange of the aircraft or any similar arrangement, by an operator who has his principal place of business, or, if he has no such place of business, his permanent residence in a Contracting and foreign State, the Government may enter into an agreement with the Government of the Contracting State in relation to the transfer of functions and duties pursuant to Article 83 *bis* of the Convention.

(4) Where an agreement has been entered into under paragraph (3), such regulations which are relevant to the functions and duties transferred by the Government to the Government of the Contracting State shall cease to apply to that aircraft as if it were not registered in Mauritius.

(5) This regulation shall have effect only where an agreement referred to in paragraph (2) or (4) is duly registered with the Council of ICAO.

134. Statistical returns

(1) The owner or operator of an aircraft or an aerodrome shall furnish to the Authority such statistical returns or information relating to the aircraft and its crew, the passengers, cargo and mail carried, the journeys made by the aircraft, and the development of any defect or failure in the aircraft, its engines or its accessories, as the Authority may require.

(2) An airline, or the owner of an aircraft engaged in a public transport service, which uses any aerodrome, air route or airway facility maintained by the Government shall, on demand, furnish to the Authority such tariff reports, cost, statistics and statistical statement, showing, amongst other things, all receipts and their sources, as the Authority may require.

135. Special directions

(1) The Authority may, by a notice to airmen, aeronautical information publication, aeronautical information circular, civil airworthiness requirements, civil air navigation requirements, dangerous goods requirements, airport circular or a notice to aircraft owners and maintenance engineers, issue special directions, not inconsistent with these regulations, relating to –

- (a) the operation, use, possession, maintenance or navigation of aircraft, including flight crew and aircraft maintenance engineer's licensing; and
- (b) the operation and maintenance of an aerodrome and air traffic control service in Mauritius.

(2) A power to issue any direction under this regulation shall include the power to issue directives or requirements with respect to different classes of aircraft, aerodromes, persons or property, different circumstances and different parts of Mauritius, and to make such incidental and supplementary provisions as are necessary or expedient for carrying out the purposes of these regulations.

135A. Exercise of Authority's powers

(1) Where any person who wishes to obtain a document from the Authority is required to make an application to the Authority, he shall –

- (a) make the application in writing in such form and manner as the Authority may determine;
- (b) at the time of making the application, pay the appropriate fee set out in the Second Schedule.

(2) On receipt of an application made under paragraph (1), the Authority –

- (a) may require the applicant to provide such information as it may require; or
- (b) consult such other person as it thinks fit.

(3) After considering an application made under paragraph (1), the Authority may –

- (a) reject the application; or
- (b) grant the application, with or without such terms and conditions as it may determine.

(4) In this regulation –

“documents” –

- (a) means a licence, a permit, an authorisation, an approval, a decision rendering the document valid or a certificate; and
- (b) includes a document witnessing a variation, an amendment or a variation of, or an exemption from, the document included in paragraph (a).

136. Application of Annexes to the Convention

(1) The Authority may, with the approval of the Minister, issue a special directive in the interest of safety so as to render effective an Annex to the Convention issued by ICAO.

(2) Any person to whom a directive has been issued shall comply with such directive.

136A. Airport Facilitation Programme

(1) The Authority shall be responsible for air transport facilitation and ensure that border crossing formalities are accomplished with respect to aircraft engaged in international operations and their passengers, crews and cargo.

(2) The Authority shall, pursuant to its powers under regulation 135, develop a written National Air Transport Facilitation Programme.

(3) Subject to paragraph (4), every airport operator shall develop and maintain an Airport Facilitation Programme consistent with the National Air Transport Facilitation Programme.

(4) No airport operator shall implement an Airport Facilitation Programme referred to in paragraph (3) or any amendment thereof, unless the programme or the amendment is approved by the Authority.

(5) Every airport operator shall make an application to the Authority, for the approval of an Airport Facilitation Programme or an amendment thereof.

(6) Where the Authority grants an application made under paragraph (5), it shall issue a written approval to the applicant.

(7) The Authority shall conduct an annual facilitation inspection, with appropriate follow up inspections of the airport operator, in order to ensure full compliance with the National Air Transport Facilitation Programme.

(8) Where the Authority conducts an inspection referred to in paragraph (7), the airport operator shall pay to the Authority the appropriate fee specified in the Second Schedule.

[Reg. 136A inserted by reg. 43 of GN 17 of 2010 w.e.f. February 2010.]

137. Offences

(1) No person shall obstruct or impede any other person acting in the exercise of his powers or in the performance of his duties under these regulations.

(2) Where, in relation to an aircraft, an offence under these regulations is committed by any person, the operator and the commander of the aircraft, shall also commit the like offence, unless he proves that the offence was committed without his knowledge or consent, and he took all necessary steps to prevent the commission of the offence.

(3) Any person who, without reasonable excuse, fails to comply with any directive or direction given to him under these regulations shall commit an offence and shall, on conviction, be liable to a fine not exceeding 10,000 rupees and to imprisonment for a term not exceeding 12 months.

(4) In any proceeding for an offence under these regulations, it shall be a sufficient defence for the person charged to show that the commission of the offence was unavoidable and could not be attributed to any failure on his part to exercise reasonable care.

(5) Where a person is charged with an offence under these regulations by reason of his having been a member of the flight crew of an aircraft on a flight for the purpose of public transport or aerial work, it shall be a sufficient defence for him to show that he neither knew nor had reason to know that the flight was for that purpose.

138. Penalties

Any person who contravenes any of these regulations shall commit an offence and shall, on conviction, be liable to a fine not exceeding 10,000 rupees and to imprisonment for a term not exceeding 12 months.

139. Saving

(1) Subject to regulations 103 and 107, these regulations shall not confer any right to any person to land in any place as against the owner of the land or any other person having an interest

therein.

(2) These regulations shall not compel the Authority to accept an application for the renewal of any current certificate, licence, approval, permission, exemption or other document, or for the granting of another document in continuation of or in substitution for the current document, where the application is not made more than 60 days before the current document is due to expire.

140. - 142. -

FIRST SCHEDULE

[Regulations 2, 6, 14 and 61]

PART I – “A” CONDITIONS

(1) An aircraft registered in Mauritius may fly for a purpose set out in paragraph (2) subject to the conditions contained in paragraphs (3) to (7) where –

- (a) it does not have a certificate of airworthiness duly issued or rendered valid under regulation 14; or
- (b) the certificate of airworthiness or certificate of validation issued in respect of the aircraft has expired or ceased to be in force by virtue of any of the matters specified in regulation 14.

(2) (a) In the case of an aircraft falling within paragraph (1)(a), the aircraft shall fly only for the purpose of enabling it to –

- (i) qualify for the issue or renewal of a certificate of airworthiness or validation thereof after an application has been made for such issue, renewal or validation as the case may be, or carry out a functional check of a modification of the aircraft;
- (ii) proceed to or from a place at which any inspection, repair, modification, maintenance, approval, test or weighing of, or the installation of equipment in, the aircraft is to take place or has taken place for a purpose referred to in subparagraph (a), after any relevant application has been made, or at which the installation of furnishings in, or the painting of, the aircraft is to be undertaken; or
- (iii) proceed to or from a place at which the aircraft is to be or has been stored.

(b) In the case of an aircraft falling within paragraph (1)(b), it shall fly only for the purpose of enabling it to –

- (i) proceed to a place at which any inspection or maintenance required by virtue of regulations 14 and 15 is to take place; or
- (ii) proceed to a place at which any inspection, maintenance or modification required by virtue of regulations 14 and 15 is to take place and in respect of which flight the Authority has given permission in writing; or
- (iii) carry out a functional check, test or in-flight adjustment in connection with the carrying out in a manner approved by the Authority of any overhaul, repair, previously approved modification, inspection or maintenance required by virtue of regulations 14 and 15.

(3) The aircraft, including any modifications, shall be of a design which previously has been approved by the Authority, or by an organisation approved for that purpose by the Authority, as being compliant with a standard accepted by the Authority as appropriate for the issue of a certificate of airworthiness under these regulations.

(4) The aircraft and its engines shall be certified as fit for flight by the holder of an aircraft maintenance engineer's licence granted under these regulations, being a licence which entitles him to issue that certificate, or by a person approved by the Authority for the purpose of issuing certificates under this condition, and in accordance with that approval.

(5) The aircraft shall carry the minimum flight crew specified in any certificate of airworthiness or

validation which has previously been in force under these regulations in respect of the aircraft, or is or has previously been in force in respect of any other aircraft of identical design, or if there is no such certificate, the aircraft shall carry such flight crew as may be necessary to ensure the safety of the aircraft.

(6) The aircraft shall not carry any person or cargo except persons performing duties in the aircraft in connection with the flight or persons who are carried in the aircraft to perform duties in connection with a purpose referred to in paragraph (2).

(7) The aircraft shall not fly over any congested area of a city, town or settlement except to the extent that it is necessary to do so in order to take off or land, at a Government aerodrome or a certificated aerodrome, in accordance with the normal aviation practice.

PART II – “B” CONDITIONS

(1) An aircraft, whether or not it is registered in accordance with regulation 6(1), may fly for a purpose set out in paragraph (2) subject to the conditions set out in paragraph (3) to (7), where –

- (a) in the case of an aircraft which is so registered, there is no certificate of airworthiness duly issued or rendered valid under the law of the country in which the aircraft is registered; or
- (b) in the case of an aircraft which is not so registered, there is no permit to fly issued by the Authority in respect of that aircraft.

(2) The aircraft shall fly only for the purpose of –

- (a) experimenting with or testing the aircraft, including any engines installed thereon, or any equipment installed or carried in the aircraft;
- (b) enabling it to qualify for the issue of a certificate of airworthiness or of validation, or the approval of a modification of the aircraft or the issue of a permit to fly;
- (c) demonstrating and displaying the aircraft, any engine installed thereon or any equipment installed or carried in the aircraft with a view to the sale thereof or of other similar aircraft, engines or equipment;
- (d) demonstrating and displaying the aircraft to employees of the operator;
- (e) the giving of flying training to or the testing of flight crew employed by the operator or training or testing of other persons employed by the operator and who are carried or are intended to be carried pursuant to paragraph (6)(b); or
- (f) proceeding to or from a place at which any experiment, inspection, repair, modification, maintenance, approval, test or weighing of the aircraft, the installation of equipment in the aircraft, demonstration, display or training is to take place for a purpose referred to in sub paragraphs (a), (b), (c), (d) or (e) or at which installation of furnishings in, or the painting of, the aircraft is to be undertaken.

(3) The flight shall be operated under the supervision of a person approved by the Authority for the purposes of the conditions specified under this Part and subject to any additional condition(s) which may be specified in such an approval, and shall carry such flight crew as may be necessary for the safety of the aircraft.

(4) Where the aircraft is not registered in Mauritius, it shall be marked in a manner approved by the Authority for the purposes of the conditions specified under this Part, and regulations 26, 27, 49, 52, 82 and 83 shall be complied with in relation to the aircraft as if it was registered in Mauritius.

(5) No person shall act as pilot in command of the aircraft except a person approved for the purpose by the Authority.

(6) The aircraft shall not carry any cargo, or person other than the following –

- (a) members of the flight crew;
- (b) persons employed by the operator who, during the flight, carry out duties or are tested or receive training in connection with a purpose specified in paragraph (2);
- (c) persons acting on behalf of the manufacturers of component parts of the aircraft, including its engines, or of equipment installed in or carried in the aircraft for carrying

out during the flight duties in connection with a purpose so specified;

- (d) persons approved by the Authority under regulation 14(10) as qualified to furnish reports for the purposes of regulation 14;
- (e) persons, other than those carried under this subparagraph, who are carried in the aircraft in order to carry out a technical evaluation of the aircraft or its operation;
- (f) cargo which comprises equipment carried in connection with a purpose specified in paragraph (2)(f); or
- (g) persons employed by the operator or persons acting on behalf of the manufacturers of component parts of the aircraft, including its engines, or of equipment installed in or carried in the aircraft in connection with a purpose specified in paragraph (2)(f) which persons have duties in connection with that purpose.

(7) The aircraft shall not fly, except in accordance with procedures which have been approved by the Authority in relation to that flight, over any congested area of a city, town or settlement.

SECOND SCHEDULE

[Regulations 4, 7, 11, 12, 12A, 14, 14A, 14B, 15, 16, 20, 21, 22, 25, 33, 33A, 33B, 36, 36A, 40A, 42, 53, 54, 63, 64, 65A, 90, 91, 91A, 91B, 91C, 103, 103A, 103B, 103C, 103D, 103E, 103F, 103G, 108, 111, 111A, 124A and 136A]

FEE

	(Rs)	
1. Exemption under regulation 4	6,000	
2. Aircraft certificate of registration under regulation 7(7)		
(1) Micro light aeroplane and single launch motor glide	5,000	
(2) Balloons and aircraft having a maximum weight of not more than 15 tonnes	10,000	
(3) Aircraft having a maximum weight of 15 tonnes	30,000	
(4) Balloons and aircraft having a maximum weight of not more than 15 tonnes	10,000	
(5) Duplicate certificate of registration	50	per cent of fee for original certificate
(6) Out of sequence registration mark	250,000	
3. Investigation fee under regulation 11(2)(a)		
(1) Aircraft weighing not more than 2 tonnes	100,000	
(2) Aircraft weighing not less than 2 tonnes	1,000,000	

	nor more than 15 tonnes		
	(3) Aircraft weighing more than 15 tonnes	1,500,000	
4.	Issue of air operator certificate under regulation 11(3)		
	(1) Aircraft weighing not more than 2 tonnes	300,000	per year
	(2) Aircraft weighing not less than 2 tonnes nor more than 15 tonnes	600,000	per year
	(3) Aircraft weighing more than 15 tonnes	1,000,000	per year
5.	Variable quarterly fee under regulation 11(7)		
	(1) Passenger aircraft	1	per hour per seat
	(2) Cargo aircraft where its capacity exceeds 20 tonnes	20	per tonne per hour
6.	Application for the inclusion of an additional aircraft type in an air operator certificate under regulation 11(8)		
	(1) For aircraft weighing not more than 2 tonnes	100,000	
	(2) For aircraft weighing not less than 2 tonnes nor more than 15 tonnes	150,000	
	(3) For every aircraft weighing not more than 15 tonnes	250,000	
7.	Variation of an air operator certificate under regulation 11(12)		
	Variation fee	100,000	
8.	Renewal of air operator certificate under regulation 12		
	(1) For every aircraft weighing not more than 2 tonnes	100,000	
	(2) For every aircraft weighing not less than 2 tonnes nor more than 15 tonnes	200,000	
	(3) For every aircraft weighing more than 15 tonnes	300,000	
9.	Route authorisation under regulation 12A	25,000	

10. Issue fee, annual fee and renewal fee for certificate of airworthiness under regulations 14(5) and 14A, respectively		
(1) A balloon	75,000	
(2) A helicopter or a powered lift (tilt rotor) aircraft, having a maximum weight of not more than 5,700 kilogrammes	50,000	
(3) An aircraft, other than a glider, balloon, helicopter or powered lift (tilt rotor) aircraft, having a maximum weight of not more than 5,700 kilogrammes	50,000	
(4) A helicopter or a powered lift (tilt rotor) aircraft having a maximum weight of not less than 5,700 kilogrammes nor more than 30,000 kilogrammes	50,000	plus 6.25 per kilogrammes or part thereof of not less than 5,700 kilogrammes nor more than 200,000 kilogrammes
(5) An aircraft, other than a glider, balloon, helicopter or powered lift (tilt rotor) aircraft, having a maximum weight of not less than 5,700 kilogrammes nor more than 30,000 kilogrammes	50,000	plus 6.25 per kilogrammes or part thereof of not less than 5,700 kilogrammes nor more than 200,000 kilogrammes
(6) An aircraft, other than a glider, balloon, helicopter or powered lift (tilt rotor) aircraft, having a maximum weight of not less than 30,000 kilogrammes but not more than 100,000 kilogrammes	200,000	plus 6.25 per kilogrammes or part thereof of not less than 30,000 kilogrammes nor more than 635,000 kilogrammes
(7) An aircraft having a maximum weight of not less than 100,000 kilogrammes nor more than 200,000 kilogrammes	635,000	plus 6.25 per kilogrammes or part thereof of not less than 100,000 kilogrammes nor more than 1,250,000 kilogrammes
(8) An aircraft having a maximum weight of not less than 200,000 kilogrammes nor more than 300,000 kilogrammes	1,250,000	plus 6.25 per kilogrammes or part thereof of not less than 200,000 kilogrammes nor more than 1,875,000 kilogrammes
(9) An aircraft having a maximum weight of not more than 300,000 kilogrammes	1,875,000	plus 6.25 per kilogrammes or part thereof of not less than 200,000 kilogrammes
11. Change of category of certificate of airworthiness under regulation 14(6A)	30,000	

12. Issue of certificate of airworthiness for export under regulation 14B		
(1) An aircraft having a maximum weight of not more than 5,700 kilogrammes	50,000	
(2) An aircraft having a maximum weight of not less than 5,700 kilogrammes	6.25	per kilogrammes
13. Approval of modification or repair under regulation 15		
(1) Modification for an aircraft having a maximum weight of not more than 2,730 kilogrammes	7,000	for the first man/hour and 7,000 for every additional man/hour or part thereof
(2) Modification for an aircraft having a maximum weight of not less than 2,730 kilogrammes	135,000	for the first 20 man/hours and 7,000 for every additional man/hour or part thereof
(3) Modification already covered by a Supplementary Type Certificate (STC)	30,000	
14. Issue and renewal of permit to fly under regulation 16		
(1) An aircraft having a maximum weight of not more than 500 kilogrammes	5,000	
(2) An aircraft having a maximum weight of not less than 500 kilogrammes but not more than 2,730 kilogrammes	10,000	
(3) Any other aircraft	30,000	
15. Aircraft maintenance engineer licence under regulation 20(1B)		
(1) Aircraft maintenance engineer – Category A		
(a) Initial issue	6,000	
(b) Renewal	3,000	
(2) Aircraft maintenance engineer – Category B1		
(a) Initial issue	6,000	
(b) Renewal	3,000	

(3) Aircraft maintenance engineer – Category B2		
(a) Initial issue	6,000	
(b) Renewal	3,000	
(4) Aircraft maintenance engineer – Category C		
(a) Initial issue	6,000	
(b) Renewal	3,000	
16. Validation of licence under regulation 20(5)	2,500	
17. Examination fee under regulation 20(10)		
Air law examination	5,000	
18. Instructors, organisations and training courses under regulation 21		
(1) Instructor		
(a) Approval	2,500	
(b) Renewal of approval	2,500	
(c) Variation of approval	2,500	
(2) Organisation		
(a) Approval	500,000	
(b) Renewal of approval	500,000	
(c) Variation of approval	30,000	
(3) Training course		
(a) Course Category A-Approval	150,000	
(b) Course Category B1-Approval	1,000,000	
(c) Course Category B2-Approval	1,000,000	
(d) Additional training course-Approval	1,000,000	
19. Approval of maintenance organisation under		

regulation 22		
(1) Issue of certificate of approval	6,000	per man/hour
(2) Renewal of certificate of approval	6,000	per man/hour
(3) Variation of certificate of approval	30,000	
20. Noise certificate under regulation 25	30,000	
21. Flight crew licences under regulation 33		
(1) Student Pilot's Licence (Aeroplanes)		
(a) Initial issue	2,500	
(b) Renewal	1,250	
(2) Private Pilot's Licence (Aeroplanes)		
(a) Initial issue	2,500	
(b) Renewal	1,250	
(3) National Private Pilot's Licence (Aeroplanes)		
(a) Initial issue	2,500	
(b) Renewal	1,250	
(4) Commercial Pilot's Licence (Aeroplanes)		
(a) Initial issue	12,500	
(b) Renewal	6,000	
(5) Airline Transport Pilot's Licence (Aeroplanes)		
(a) Initial issue	12,500	
(b) Renewal	6,000	
(6) Private Pilot's Licence (Helicopters)		
(a) Initial issue	2,500	
(b) Renewal	1,250	

(7) Private Pilot's Licence (Gyroplanes)		
(a) Initial issue	2,500	
(b) Renewal	2,500	
(8) Commercial Pilot's Licence (Helicopters and Gyroplanes)		
(a) Initial issue	12,500	
(b) Renewal	6,000	
(9) Private Pilot's Licence (Balloons and Airships)		
(a) Initial issue	2,500	
(b) Renewal	1,250	
(10) Commercial Pilot's Licence (Balloons)		
(a) Initial issue	12,500	
(b) Renewal	6,000	
(11) Commercial Pilot's Licence (Airships)		
(a) Initial issue	12,500	
(b) Renewal	6,000	
(12) Commercial Pilot's Licence (Gliders)		
(a) Initial issue	12,500	
(b) Renewal	6,000	
(13) Flight Navigator's Licence		
(a) Initial issue	8,000	
(b) Renewal	4,000	
(14) Flight Engineer's Licence		
(a) Initial issue	8,000	
(b) Renewal	4,000	

(15) Flight Radiotelephony Operator's Licence-Issue	3,000	
22. Inclusion of rating under regulation 33(4) and (22)	2,500	per rating
23. Endorsement of licence with a valid medical certificate under regulation 33(10)	1,500	
24. Instructor, organisation, training course and examiner under regulation 33A		
(1) Instructor		
Type rating instructor		
(a) Approval	2,500	
(b) Renewal of approval	2,500	
(2) Organisation		
Foreign flight training organisation		
(a) Approval	60,000	
(b) Renewal of approval	60,000	
(3) Training course		
Ground training course		
Approval	150,000	
(4) Examiner		
(a) Instrument rating examiner		
(i) Approval	2,500	
(ii) Renewal of approval	2,500	
(b) Revalidation type rating examiner		
(i) Approval	5,000	
(ii) Renewal of approval	5,000	
25. Approval of simulator under regulation 33B		

(1) Approval and renewal	60,000	per simulator
(2) Ad hoc approval (less than 4 months)	30,000	per simulator
26. Validation of licence under regulation 36		
For any type of licence	2,500	
27. Certificate of authenticity under regulation 36A	3,000	
28. Crew member certificate under regulation 40A		
(1) Initial Issue	2,000	
(2) Renewal	2,000	
(3) Issue of duplicate	2,000	
29. Approval of training manual under regulation 42		
(1) Initial approval	100,000	
(2) Approval of amendment	3,500	per man/hour
30. Navigation systems under regulation 53		
Approval of navigation system, other than a height keeping performance system	50,000	
31. Height keeping performance systems under regulation 54		
Approval	50,000	
32. Aerial application certificate under regulation 63		
Issue and renewal	50,000	
33. Carriage of munitions of war and weapons under regulation 64		
(1) Approval for carriage of munition of war	3,000	
(2) Approval for carriage of sporting weapon	3,000	
34. Dangerous goods manual under regulation 65A		

Approval of dangerous goods manual	50,000	
35. Permission under regulation 90	3,000	per permission
35A. Permission under regulation 91	1,000	per permission
35B. Permission under regulation 91A	1,000	per permission
35C. Permission under regulation 91B	10,000	for 3 years
	10,000	for renewals for successive periods of 3 years
35D. Permission under regulation 91C	1,000	per permission
36. Licensing of aerodromes under regulation 103		
(1) Monthly fee payable by holder of valid aerodrome licence	7	per arriving passenger in preceding month
(2) Approval of aerodrome manual	40,000	
(3) Approval of safety management system manual	100,000	
(4) Approval of aerodrome emergency manual	100,000	
(5) Approval of airside driving manual	15,000	
37. Instructor, training course and examiner under regulation 103A		
(1) Instructor		
(a) Approval	5,000	
(b) Renewal of approval	5,000	
(2) Training course		
Approval	1,000	per man/hour
(3) Examiner		
(a) Approval	5,000	
(b) Renewal of approval	5,000	

38. Inspection of aerodrome under regulation 103B		
(1) Audit and inspection of aerodrome	150,000	
(2) Follow up audit	75,000	
(3) Partial audit	50,000	
(4) Follow up and partial audit	25,000	
(5) Audit of medical facilities at the aerodrome	25,000	
(6) Apron safety audit at the aerodrome	40,000	
(7) Night inspection audit of the aerodrome	20,000	
39. Helipad under regulation 103C		
(1) Issue of approval	50,000	
(2) Renewal of approval	50,000	
40. Airside vehicle permit under regulation 103D		
(1) Issue of airside vehicle permit	3,000	
(2) Renewal of airside vehicle permit	3,000	
41. Airside vehicle licence under regulation 103E		
(1) Issue of airside vehicle licence	3,000	
(2) Renewal of airside vehicle licence	3,000	
42. Passenger boarding bridge under regulation 103F		
(1) Issue of approval	3,000	
(2) Renewal of approval	3,000	
43. Passenger boarding bridge operator permit under regulation 103G		
(1) Issue of passenger boarding bridge operator permit	3,000	
(2) Renewal of passenger boarding bridge operator permit	3,000	

44. Permission relating to aeronautical ground lights under regulation 108	3,000	
45. Aviation fuel installation under regulation 111		
(1) Less than 5,000 fuelling per year		
(a) Approval	100,000	
(b) Renewal of approval	100,000	
(2) 5,000 or more fuelling per year		
(a) Approval	1,000,000	
(b) Renewal of approval	1,000,000	
46. Ground handling service under regulation 111A		
(1) Issue of approval	250,000	
(2) Renewal of approval	250,000	
47. Medical examiner under regulation 124A		
(1) Medical Examiner-Class 1		
(a) Registration	3,000	
(b) Renewal of registration	3,000	
(2) Medical Examiner-Class 2		
(a) Registration	2,000	
(b) Renewal of registration	2,000	
48. Airport Facilitation Programme under regulation 136A		
(1) Initia-I approval	50,000	
(2) Approval of amendment	500	per man/hour
(3) Facilitation inspection	500	per man/hour

THIRD SCHEDULE

[Regulations 2 and 7]

TABLE OF GENERAL CLASSIFICATION OF AIRCRAFT

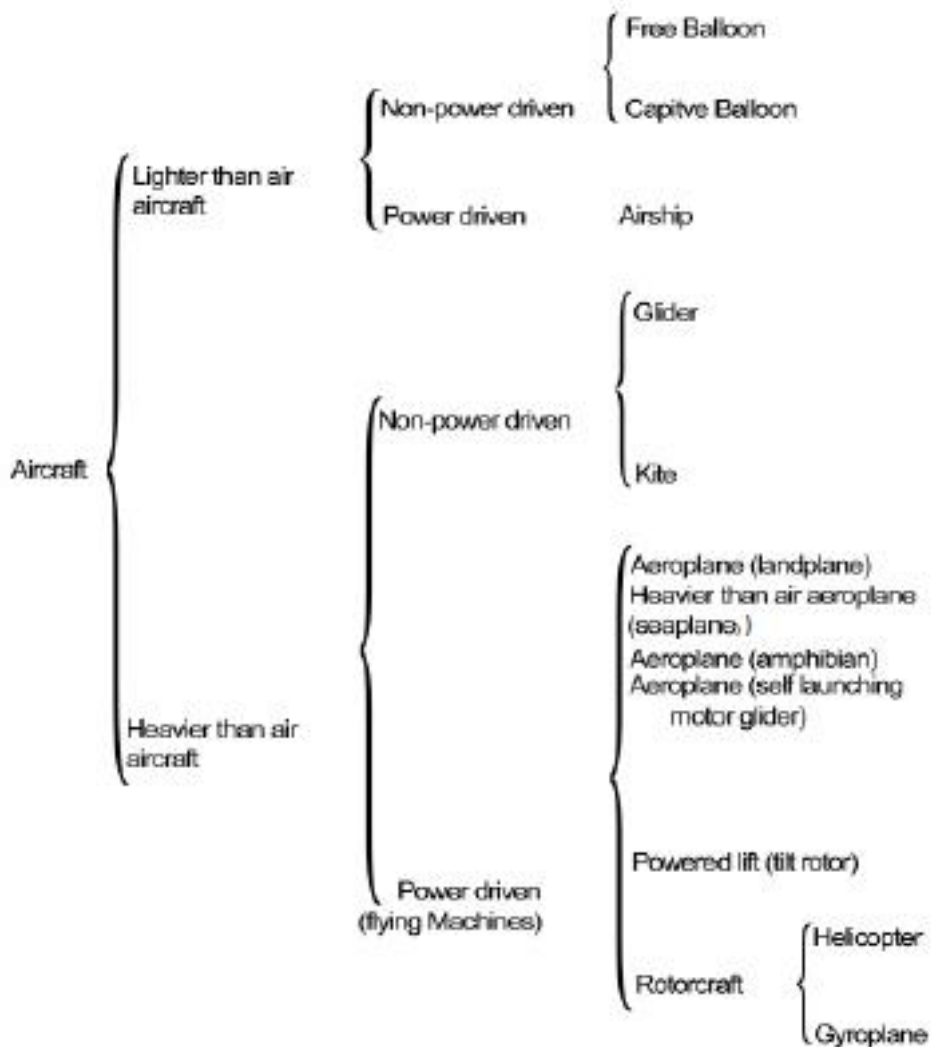

FOURTH SCHEDULE

[Regulations 7 and 14]

PART I – FORM OF CERTIFICATE OF REGISTRATION

GOVERNMENT OF MAURITIUS

DEPARTMENT OF CIVIL AVIATION

CERTIFICATE OF REGISTRATION

1. Nationality and registration marks	2. Manufacturer and manufacturer's designation of aircraft	3. Aircraft serial number
---------------------------------------	--	---------------------------

.....
----------------	----------------	----------------

4. Name of owner
5. Address of owner
-

6. It is hereby certified that the aircraft specified above has been duly entered on the Civil Aircraft Register in accordance with the Convention on International Civil Aviation dated 7 December 1944 and the Civil Aviation Regulations 2007.

.....

Date of issue

.....

Name

.....

Designation

.....

Signature

Director of Civil Aviation

.....

Seal

PART II – FORM OF CERTIFICATE OF AIRWORTHINESS
GOVERNMENT OF MAURITIUS
DEPARTMENT OF CIVIL AVIATION
CERTIFICATE OF AIRWORTHINESS

1. Nationality and registration marks	2. Manufacturer and manufacturer's designation of aircraft	3. Aircraft serial number
--	---	----------------------------------

4. Categories
5. This Certificate of Airworthiness is issued pursuant to the Convention on International Civil Aviation dated 7 December 1944 and the Civil Aviation Regulations 2007 in respect of the aircraft mentioned above which is considered to be airworthy when maintained and operated in accordance with the foregoing and the pertinent operating limitations.
6. This certificate will be valid until

.....

Date of issue

.....

Name

.....

Designation

.....

Signature

Director of Civil Aviation

.....
Seal

FIFTH SCHEDULE

[Regulation 10]

NATIONALITY AND REGISTRATION MARKS OF AIRCRAFT REGISTERED IN MAURITIUS

1. General

(1) (a) The nationality mark of the aircraft shall be the numeral 3 followed by the capital letter 'B' and the registration mark shall be a group of 3 capital letters in Roman characters assigned by the Authority on the registration of the aircraft.

(b) The letters shall be without ornamentation and a hyphen shall be placed between the nationality mark and the registration mark.

(2) The nationality and registration marks shall be painted on the aircraft or shall be affixed thereto by any other means ensuring a similar degree of permanence in the manner specified in paragraphs 2 and 3 of this Schedule.

(3) The nationality and registration marks shall be displayed to the best advantage, taking into consideration the constructional features of the aircraft and shall always be kept clean and visible.

(4) The letters constituting every group of marks shall be of equal height and they, and the hyphen, shall be of the same single colour which shall clearly contrast with the background on which they appear.

(5) The nationality and registration marks shall be inscribed together with the name and address of the registered owner of the aircraft on a fire-proof metal plate affixed in a prominent position as follows –

- (a) in the case of a microlight aeroplane, in accordance with sub subparagraph (c) or on the wing;
- (b) in the case of a balloon, on the basket or envelope; or
- (c) in the case of any other aircraft, on the fuselage or car, as the case may be.

2. Position and size of marks

(1) The position and size of marks on heavier than air aircraft, excluding kites, shall be –

- (a) on the horizontal surfaces of the wings –
 - (i) on an aircraft having a fixed wing surface, the marks shall –
 - (A) appear on the lower surface of the wing structure and shall be on the port wing unless they extend across the whole surface of both wings;
 - (B) as far as is possible, be located equidistant from the leading and trailing edges of the wings;
 - (C) have the tops of the letters towards the leading edge of the wing;
 - (ii) the height of the letters shall be –
 - (A) subject to sub subparagraph (B), at least 50 centimetres;
 - (B) if the wings are not large enough for the marks to be 50 centimetres in height, marks of the greatest height practicable in the circumstances;
- (b) on the fuselage, or equivalent structure, and vertical tail surfaces –
 - (i) the marks shall also appear –
 - (A) on each side of the fuselage, or equivalent structure, and shall, in the case of fixed wing aircraft, be located between the wings and the horizontal tail

surface; or

- (B) on the vertical tail surfaces;
 - (ii) when located on a single vertical tail surface, the marks shall appear on both sides;
 - (iii) when located on multi-vertical tail surfaces, the marks shall appear on the outboard sides of the outer tail surfaces;
 - (iv) subject to sub sub subparagraphs (vi) and (vii), the height of the letters constituting each group of marks shall be at least 30 centimetres;
 - (v) where one of the surfaces authorised for displaying the required marks is large enough for those marks to be 30 centimetres in height whilst complying with sub sub subparagraph (vii) and the other is not, marks of 30 centimetres in height shall be placed on the largest authorised surface;
 - (vi) where the authorised surfaces are not large enough for marks of 30 centimetres in height, whilst complying with sub sub subparagraph (vii), marks of the greatest height practicable in the circumstances shall be displayed on the larger of the 2 authorised surfaces;
 - (vii) the marks on the vertical tail surfaces shall be such as to leave a margin of at least 5 centimetres along each side of the vertical tail surface;
 - (viii) on rotary wing aircraft where owing to the structure of the aircraft the greatest height practicable for the marks on the side of the fuselage, or equivalent structure, is less than 30 centimetres, the marks shall also appear on the lower surface of the fuselage as close to the line of symmetry as is practicable and be placed with the tops of the letters towards the nose and the height of the letters constituting each group of marks shall be –
 - (A) subject to sub subparagraph (B), at least 50 centimetres; or
 - (B) if the lower surface of the fuselage is not large enough for the marks to be of 50 centimetres in height, marks of the greatest height practicable in the circumstances;
 - (c) wherever in this paragraph marks of the greatest height practicable in the circumstances are required, that height shall be such as is consistent with paragraph 3.
- (2) The position and size of marks on airships and free balloons shall be –
- (a) in the case of airships, the marks shall be placed on each side of the airship. They shall be placed horizontally either on the hull near the maximum cross-section of the airship or on the lower vertical stabiliser;
 - (b) in the case of free balloons, the marks shall be in 2 places on diametrically opposite sides of the balloon near maximum horizontal circumference of the balloon;
 - (c) in the case of both airships and free balloons the side marks shall be so placed as to be visible from the sides and from the ground. The height of the letters shall be at least 50 centimetres.

3. Width, spacing and thickness of marks

- (1) In this paragraph –
 - “standard letter” means any letter other than the letter I.
- (2) (a) The width of every standard letter and the length of the hyphen between the nationality mark and the registration mark shall be two-thirds of the height of a letter.
- (b) The width of the letters M and W shall be neither less than two-thirds of their height nor more than their height.
- (c) The width of the letter I shall be one-sixth of the height of the letter.
- (3) The thickness of the lines comprising every letter and hyphen shall be one-sixth of the height of the letters forming the marks.

(4) Every letter and hyphen shall be separated from the letter or hyphen which it immediately precedes or follows, by a space equal to one quarter or one-half of the width of a standard letter. Every such space shall be equal to every other such space within the marks.

SIXTH SCHEDULE

[Regulations 14 and 19(2)(b)]

CATEGORIES OF AIRCRAFT

Categories of aircraft	Purpose
Transport category (passenger)	Any purpose
Transport category (cargo)	Any purpose other than public transport of passengers
Aerial work category	Aerial work only
Private category	Any purpose other than public transport or aerial work
Special category	Any purpose other than public transport, specified in the certificate of airworthiness, but not, including the carriage of passengers unless expressly permitted

SEVENTH SCHEDULE

[Regulations 2, 19(4), 43(1), 44(4), 53(2), and 54(1)]

PART I – APPROVED REQUIREMENTS

1. General

(1) In this Schedule –

“specified”, in relation to an aircraft, means specified in, or ascertainable by reference to –

- (a) the certificate of airworthiness in force under these regulations in respect of that aircraft; or
- (b) the flight manual or performance schedule included in that certificate or other document, whatever its title, incorporated by reference in that certificate.

(2) For the purposes of this Schedule –

- (a) the mass of an aeroplane at the commencement of the take-off run shall be taken to be its gross, including everything and everyone carried in or on it at the commencement of the take-off run;
- (b) the landing mass of an aeroplane shall be taken to be the mass of the aeroplane at the estimated time of landing allowing for mass of the fuel and oil expected to be used on the flight to the aerodrome at which it is intended to land or alternate aerodrome, as the case may be;
- (c) where any distance referred to in regulation 2 has been –
 - (i) declared in respect of any aerodrome by the authority responsible for regulating air navigation over the territory of the Contracting State in which the aerodrome is situated; or
 - (ii) notified in the case of an aerodrome in Mauritius,

that distance shall be the relevant distance.

(3) This Schedule shall not apply to an aircraft flying solely for the purpose of training any person to perform duties in an aircraft.

2. Load sheets

- (1) Every load sheet required by regulation 44 shall contain the following particulars –
- (a) the nationality mark of the aircraft to which the load sheet relates, and the registration mark assigned to that aircraft by the Authority;
 - (b) particulars of the flight to which the load sheet relates;
 - (c) the total mass of the aircraft as loaded for that flight;
 - (d) the mass of the several items from which the total mass of the aircraft, as so loaded, has been calculated, including in particular the mass of the aircraft prepared for service and the respective total mass of the crew, unless included in the mass of the aircraft prepared for service, passengers, baggage and cargo intended to be carried on the flight;
 - (e) the manner in which the load is distributed and the resulting position of the centre of gravity of the aircraft which may be given approximately if and to the extent that the relevant certificate of airworthiness so permits,

and shall include, at the foot or end of the load sheet, a certificate, signed by the person referred to in regulation 44 as responsible for the loading of the aircraft, to the effect that the aircraft has been loaded in accordance with the written instruction furnished to him by the operator of the aircraft pursuant to the said regulation 44.

(2) (a) Subject to sub subparagraph (b), for the purpose of calculating the total mass of the aircraft, the respective total mass of the passengers and crew together with their hand baggage entered in the load sheet shall be computed from the actual mass of each person and his hand baggage and for that purpose each person and his hand baggage shall be separately weighed.

(b) The total mass of the passengers and crew together with their hand baggage may, subject to subparagraph (4), be calculated by taking the mass of every person and his hand baggage as not less than the appropriate mass shown in Table 1 or 2 and the load sheet shall bear a notation to that effect.

TABLE 1

	Passenger seats available		
	20 or more		30 or more
	Male	Female	All adult
	(kg)	(kg)	(kg)
Passengers on all flights except holiday charters	88	70	84
Passengers on holiday charters	83	69	76
Children (between 2-12 years) or infants under 2 years of age if occupying a separate seat	35	35	
Infants under 2 years of age if sharing a seat with an adult	0	0	

Flight crew	85	85	
Cabin crew	75	75	

TABLE 2

	Passenger seats available		
	1-5 (kg)	6-9 (kg)	10-19 (kg)
Male passengers	104	96	92
Female passengers	86	78	74
Children (between 2-12 years) or infants under 2 years of age if occupying a separate seat	35	35	35
Infants under 2 years of age if sharing a seat with an adult	0	0	0
Flight crew	85	85	85
Cabin crew	75	75	75

(c) Where the total number of passenger seats available on an aircraft is 20 or more, the mass for males and females in Table 1 are applicable. As an alternative, where the total number of passenger seats available is 30 or more, the all adult mass in Table 1 may be used for passengers over the age of 12 years.

(d) For the purpose of Table 1 –

“holiday charter” means a flight by an aircraft for the carriage of passengers each of whom is carried pursuant to an agreement which provides for carriage by air to a place outside Mauritius and back from that place, or from another place, to Mauritius, whether or not on the same aircraft, and for accommodation at a place outside Mauritius, vice versa.

(e) Where the total number of passenger seats available on an aircraft is 19 or less, Table 2 shall be applicable instead of Table 1.

(f) On flights where no hand baggage is carried or where such hand baggage is accounted for separately, 6 kilogrammes may be deducted from the mass of passengers over 12 years of age when using Table 2.

(g) Where any immersion suit is worn or carried by a passenger or crew member, 3 kilogrammes shall be added to the appropriate mass shown in Table 1 or 2 in each such case.

(3) (a) Subject to sub subparagraph (b), for the purpose of calculating the total mass of the aircraft, the respective total masses of the hold baggage and cargo entered in the load sheet shall be computed from the actual mass of every piece of baggage, cargo or cargo container and for that purpose every piece or container shall be separately weighed.

(b) In the case of an aircraft where the total number of passenger seats available is 20 or more, the total mass of the hold baggage may, subject to subparagraph (4), be calculated by taking the mass of every piece as not less than the appropriate mass shown in Table 3 and the load sheet shall bear a notation to that effect.

TABLE 3

Journey made by aircraft	Hold baggage per piece (kg)
Domestic	11
Regional	13
Intercontinental	15

(c) For the purposes of Table 3 –

- (i) a journey made by an aircraft shall be treated as domestic if it is between 2 places located within the territories and dependencies of Mauritius;
- (ii) a journey made by an aircraft to or from Mauritius, not being a domestic journey, shall be treated as regional if it is confined to Seychelles, Madagascar, Reunion, and Comoros;
- (iii) a journey made by an aircraft to or from Mauritius shall be treated as intercontinental if it does not fall under sub sub subparagraph (i), or sub sub subparagraph (ii).

(4) (a) Where it appears to the person supervising the loading of the aircraft that –

- (i) the mass of any person and his hand baggage to be carried exceeds the appropriate mass set out in Table 1 or 2, or where subparagraph (2)(f) applies, exceeds the appropriate mass set out in Table 2 as adjusted in accordance with that subparagraph; or
- (ii) any hold baggage to be carried exceeds the mass set out in Table 3,

he shall, if he considers it necessary in the interests of the safety of the aircraft, or if the Authority has so directed in the particular case, require any such person and his hand baggage, or the hold baggage, as the case may be, to be weighed for the purpose of the entry to be made in the load sheet.

(b) If any person and his hand baggage, or any hold baggage, has been weighed pursuant to sub subparagraph (a), the masses entered in the load sheet shall take account of the actual mass of that person and his hand baggage, or that hold baggage, as the case may be, or of the mass determined in accordance with Table 1, 2 or 3, as applicable, whichever is greater.

3. Mass and performance – general provisions

(1) (a) Subject to sub subparagraph (b), the assessment of the ability of an aeroplane to comply with the requirements of paragraphs 4 to 9 and of a helicopter to comply with the requirements of paragraphs 15 to 17, (relating in case to mass, performance and flights in specified meteorological conditions or at night), shall be based on the specified information as to its performance.

(b) In the case of an aeroplane in respect of which there is in force under these regulations a certificate of airworthiness which does not include a performance group classification, the assessment may be based on the best information available to the commander of the aircraft, insofar as the relevant information is not specified.

(2) In assessing the ability of an aeroplane to comply with the condition (7) of the annexure, paragraph 5(2) and (3) and paragraph 10 (2)(e), (f) and (3), account may be taken of any reduction of the mass of the aeroplane which may be achieved after the failure of a power unit by such jettisoning of fuel as is feasible and prudent in the circumstances of the flight and in accordance with the flight manual included in the certificate of airworthiness relating to the aircraft.

4. Mass and performance of public transport aeroplanes having no performance group classification in their certificates of airworthiness

For the purpose of regulation 45(1), an aeroplane registered in Mauritius, in respect of which

there is in force under these regulations, a certificate of airworthiness which does not include a performance group classification shall not fly for the purpose of public transport unless the mass of the aeroplane at the commencement of the take-off run is such that the conditions specified in Part II of this Schedule as apply to that aircraft are satisfied.

5. Mass and performance of public transport aeroplanes classified as aeroplanes of performance group A or performance group B in their certificates of airworthiness

(1) For the purpose of regulation 45(1), an aeroplane registered in Mauritius in respect of which there is in force, under these regulations, a certificate of airworthiness in which the aeroplane is designated as being of performance group A or performance group B shall not fly for the purpose of public transport unless the mass of the aeroplane at the commencement of the take-off run is such that the following conditions are satisfied –

- (a) that mass does not exceed the maximum take-off mass specified for the altitude and the air temperature at the aerodrome at which the take-off is to be made;
- (b) the take-off run, distance and the emergency distance respectively required for take-off, specified as being appropriate to –
 - (i) the mass of the aeroplane at the commencement of the take-off run;
 - (ii) the altitude at the aerodrome;
 - (iii) the air temperature at the aerodrome;
 - (iv) the condition of the surface of the runway from which the take-off will be made;
 - (v) the slope of the surface of the aerodrome in the direction of take-off over the take-off run available, the take-off distance available and the emergency distance available, respectively; and
 - (vi) not more than 50 per cent of the reported wind component opposite to the direction of take-off or not less than 150 per cent of the reported wind component in the direction of take-off,

do not exceed the take-off run, distance and the emergency distance available, respectively, at the aerodrome at which the take-off is to be made, in ascertaining the emergency distance required, the point at which the pilot is assumed to decide to discontinue the take-off shall not be nearer to the start of the take-off run than the point at which, in ascertaining the take-off run required and the take-off distance required, he is assumed to decide to continue the take-off, in the event of power unit failure;

- (c) the net take-off flight path with one power unit inoperative, specified as being appropriate to –
 - (i) the mass of the aeroplane at the commencement of the take-off run;
 - (ii) the altitude at the aerodrome;
 - (iii) the air temperature at the aerodrome; and
 - (iv) not more than 50 per cent of the reported wind component opposite to the direction of take-off or not less than 150 per cent of the reported wind component in the direction of take-off,

and plotted from a point 35 or 50 feet, as appropriate, above the end of the take-off distance required at the aerodrome at which the take-off is to be made to a height of 1,500 feet above the aerodrome, shows that the aeroplane will clear any obstacle in its path by a vertical interval of at least 35 feet, and if it is intended that the aeroplane shall change its direction of flight by more than 15 degrees before reaching 1,500 feet, the vertical interval shall not be less than 50 feet during the change of direction;

- (d) for the purpose of sub subparagraph (c), an obstacle shall be in the path of the aeroplane if the distance from the obstacle to the nearest point on the ground below the intended line of flight of the aeroplane does not exceed –
 - (i) a distance of 60 metres plus half the wing span of the aeroplane plus one-eighth of the distance from such point to the end of the take-off distance available measured

along the intended line of flight of the aeroplane; or

(ii) 900 metres,

whichever is the lesser.

(e) In assessing the ability of the aeroplane to satisfy this condition, it shall not be assumed to make a change of direction of a radius less than the specified radius of steady turn.

(2) (a) Subject to sub subparagraph (b), the aeroplane shall, in the meteorological conditions expected for the flight, in the event of any one power unit becoming inoperative at any point on its route or on any planned diversion therefrom and with the other power unit or units operating within the maximum continuous power conditions specified, be capable of continuing the flight, clearing by a vertical interval of at least 2,000 feet obstacles within 10 nautical miles either side of the intended track, to an aerodrome at which it may comply with subparagraph (5), relating to an alternate aerodrome, and on arrival over such aerodrome the gradient of the specified net flight path with one power unit inoperative shall not be less than zero at 1,500 feet above the aerodrome, and in assessing the ability of the aeroplane to satisfy this condition, it shall not be assumed to be capable of flying at an altitude exceeding the specified maximum permissible altitude for power unit restarting.

(b) Where the operator of the aeroplane is satisfied, taking into account the navigation aids which may be used by the aeroplane on the route, that the commander of the aeroplane will be able to maintain his intended track on that route within a margin of 5 nautical miles, this subparagraph shall have effect as if 5 nautical miles were substituted for 10 nautical miles.

(3) (a) Subject to sub subparagraph (b), the aeroplane, if it has 3 or more power units, shall, in the meteorological conditions expected for the flight, in the event of any 2 power units becoming inoperative at any point along the route or on any planned diversion therefrom more than 90 minutes flying time in still air at the all power units operating economical cruise speed from the nearest aerodrome at which it can comply with subparagraph (5), relating to an alternate aerodrome, be capable of continuing the flight with all other power units operating within the specified maximum continuous power conditions, clearing by a vertical interval of at least 2,000 feet obstacles within 10 nautical miles either side of the intended track to such an aerodrome, and on arrival over such an aerodrome the gradient of the specified net flight path with 2 power units inoperative shall not be less than zero at 1,500 feet above the aerodrome, and in assessing the ability of the aeroplane to satisfy this condition, it shall not be assumed to be capable of flying at an altitude exceeding the specified maximum permissible altitude for power unit restarting.

(b) Where the operator of the aeroplane is satisfied, taking into account the navigation aids which may be used by the aeroplane on the route, that the commander of the aeroplane will be able to maintain his intended track on that route within a margin of 5 nautical miles, this sub subparagraph shall have effect as if 5 nautical miles were substituted for 10 nautical miles.

(c) The aeroplane, if it has 2 power units and a maximum total authorised mass which exceeds 5,700 kilogrammes and is not limited by its certificate of airworthiness to the carriage of less than 20 passengers, shall, in the meteorological conditions expected for the flight, at any point along the route or on any planned diversion therefrom, not be more than 60 minutes flying time at the normal one engine inoperative cruise speed in still air from the nearest aerodrome at which it may comply with subparagraph (5), relating to an alternate aerodrome, unless it is flying under and in accordance with the terms of any written permission granted by the Authority to the operator under these regulations.

(d) The aeroplane, if it has 2 power units and a maximum total authorised mass of 5,700 kilogrammes or less or 2 power units and a maximum total authorised mass of more than 5,700 kilogrammes but which is limited by its certificate of airworthiness to the carriage of less than 20 passengers shall, in the meteorological conditions expected for the flight, not be more than 90 minutes flying time in still air at the all power units operating economical cruise speed from the nearest aerodrome at which it can comply with subparagraph (5), relating to an alternate aerodrome.

(4) The landing mass of the aeroplane shall not exceed the maximum landing mass specified for the altitude and the expected air temperature for the estimated time of landing at the aerodrome at which it is intended to land and at any alternate aerodrome.

(5) (a) In the case of a turbine jet powered aeroplane, the landing distance required shall not exceed at the aerodrome at which it is intended to land or at any alternate aerodrome, as the case may

be, the landing distance available on –

- (i) the most suitable runway for a landing in still air conditions; and
- (ii) the runway that may be required for landing because of the forecast wind conditions.

(b) (i) Subject to sub sub subparagraph (ii), in the case of an aeroplane powered by turbine propeller or piston engines, the landing distances required, respectively specified as being appropriate to aerodromes of destination and alternate aerodromes, shall not exceed at the aerodrome at which it is intended to land or at any alternate aerodrome, as the case may be, the landing distance available on –

- (A) the most suitable runway for a landing in still air conditions; and
- (B) the runway that may be required for landing because of the forecast wind conditions;

(ii) Where an alternate aerodrome is designated in the flight plan, the specified landing distance required may be that appropriate to an alternate aerodrome when assessing the ability of the aeroplane to satisfy this condition at the aerodrome of destination.

(c) For the purposes of sub subparagraph (a), the landing distance required shall be that specified as being appropriate to –

- (i) the landing mass;
- (ii) the altitude of the aerodrome;
- (iii) the temperature in the specified international standard atmosphere appropriate to the altitude at the aerodrome;
- (iv) a level surface in the case of runways usable in both directions, or the average slope of the runway in the case of runways usable in only one direction; and
- (v) still air conditions in the case of the most suitable runway for a landing in still air conditions, or not more than 50 per cent of the forecast wind component opposite to the direction of landing or not less than 150 per cent of the forecast wind component in the direction of landing in the case of the runway that may be required for landing because of the forecast wind conditions.

6. Mass and performance of public transport aeroplanes classified as aeroplanes of performance Group C in their certificates of airworthiness

(1) For the purpose of regulation 45(1), an aeroplane registered in Mauritius in respect of which there is in force under these regulations a certificate of airworthiness in which the aeroplane is designated as being of performance group C shall not fly for the purpose of public transport unless the mass of the aeroplane at the commencement of the take-off run is such that the following conditions are satisfied –

- (a) the mass does not exceed the maximum take-off mass specified for the altitude and the air temperature at the aerodrome at which the take-off is to be made;
- (b) the take-off run required and the take-off distance required, specified as being appropriate to –
 - (i) the mass of the aeroplane at the commencement of the take-off run;
 - (ii) the altitude at the aerodrome;
 - (iii) the air temperature at the aerodrome;
 - (iv) the average slope of the surface of the aerodrome in the direction of take-off over the emergency distance available; and
 - (v) not more than 50 per cent of the reported wind component opposite to the direction of take-off or not less than 150 per cent of the reported wind component in the direction of take-off,

do not exceed the take-off run available and the emergency distance available, respectively, at the aerodrome at which the take-off is to be made;

- (c) subject to sub subparagraph (d) and subparagraphs (2) and (3), the net take-off flight path with all power units operating specified as being appropriate to –
 - (i) the mass of the aeroplane at the commencement of the take-off run;
 - (ii) the altitude of the aerodrome;
 - (iii) the air temperature at the aerodrome; and
 - (iv) not more than 50 per cent of the reported wind component opposite to the direction of the take-off or not less than 150 per cent of the reported wind component in the direction of take-off,

and plotted from a point 50 feet above the end of the take-off distance required at the aerodrome at which the take-off is to be made to a height of 1,500 feet above the aerodrome shows that the aeroplane will clear any obstacle in its path by a vertical interval of not less than 35 feet, and if it is intended that the aeroplane shall change its direction of flight by more than 15 degrees before reaching 1,500 feet, the vertical interval shall be not less than 50 feet during the change of direction;

- (d) subject to subparagraphs (2) and (4), in the case of an aeroplane which is intended to be flown for any period before reaching a height of 1,500 feet above the aerodrome from which the take-off is to be made in conditions which will not ensure that any obstacle may be located by means of visual observation, the net take-off flight path with one power unit inoperative specified as being appropriate to the factors contained in sub subparagraph (c), and plotted from the point of the net take-off flight path with all power units operating specified as being appropriate to those factors at which in the meteorological conditions expected for the flight the loss of visual reference would occur, shows that the aeroplane will clear by a vertical interval of not less than 35 feet any obstacle in its path; and if it is intended that the aeroplane shall change its direction of flight by more than 15 degrees before reaching 1,500 feet the vertical interval shall not be less than 50 feet during the change of direction;
- (e) subject to subparagraph (5), the aeroplane, at any time after it reaches a height of 1,500 feet above the aerodrome from which the take-off is made will, in the meteorological conditions expected for the flight, in the event of any one power unit becoming inoperative at any point on its route or on any planned diversion therefrom, and with the other power unit or power units operating within the specified maximum continuous power conditions, be capable of continuing the flight at altitudes not less than the relevant minimum altitude for safe flight stated in, or calculated from the information contained in, the operations manual relating to the aeroplane to a point 1,500 feet above an aerodrome at which a safe landing may be made and, after arrival at that point, be capable of maintaining that height;
- (f) the landing mass of the aeroplane will not exceed the maximum landing mass specified for the altitude and the expected air temperature for the estimated time of landing at the aerodrome at which it is intended to land and at any alternate aerodrome;
- (g) subject to sub subparagraph (h), the distance required by the aeroplane to land from a height of 50 feet otherwise than in accordance with specified data for short field landing does not, at the aerodrome at which it is intended to land and at any alternate aerodrome, exceed 70 per cent of the landing distance available on the most suitable runway for a landing in still air conditions, and on the runway that may be required for landing because of the forecast wind conditions, and for the purposes of this condition the distance required to land from a height of 50 feet shall be taken to be that specified as being appropriate to –
 - (i) the landing mass;
 - (ii) the altitude at the aerodrome;
 - (iii) the temperature in the specified international standard atmosphere appropriate to the altitude at the aerodrome;
 - (iv) the level surface in the case of runways usable in both directions, or the average

slope of the runway in the case of runways usable in only one direction; and

- (v) still air conditions in the case of the most suitable runway for landing in still air conditions, or not more than 50 per cent of the forecast wind component opposite to the direction of landing or not less than 150 per cent of the forecast wind component in the direction of landing in the case of the runway that may be required for landing because of the forecast wind conditions;
- (h) as an alternative to sub subparagraph (g), and subject to subparagraphs (6) and (7), the distance required by the aeroplane, with all power units operating or with one power unit inoperative, to land in accordance with specified data for short field landing, does not at the aerodrome of intended destination and at any alternate aerodrome exceed the landing distance available on the most suitable runway for a landing in still air conditions and on the runway that may be required for landing because of the forecast wind conditions, and for the purposes of this condition the distance required to land from the appropriate height shall be taken to be that specified as being appropriate to the factors set forth in sub subparagraph (g)(i) to (v) and the appropriate height shall be –
 - (i) for a landing with all power units operating – any height between 30 and 50 feet in Mauritius, and 50 feet elsewhere; and
 - (ii) for a landing with one power unit inoperative – 50 feet in Mauritius and elsewhere.

(2) In assessing the ability of the aeroplane to satisfy subparagraph (1)(c) and (d), it shall not be assumed to make a change of direction of a radius less than the specified radius of steady turn.

(3) For the purpose of subparagraph (1)(c), an obstacle shall be considered to be in the path of the aeroplane if the distance from the obstacle to the nearest point on the ground below the intended line of flight of the aeroplane does not exceed 75 metres.

(4) For the purpose of subparagraph (1)(d), an obstacle shall be considered to be in the path of the aeroplane if the distance from the obstacle to the nearest point on the ground below the intended line of flight of the aeroplane does not exceed 75 metres plus one-eighth of the distance from such point to the end of the emergency distance available along the intended line of flight of the aeroplane, or 900 metres, whichever is the lesser.

(5) In assessing the ability of the aeroplane to satisfy subparagraph (1)(e), it shall not be assumed to be capable of flying at any point on its route at an altitude exceeding the performance ceiling, with all power units operating, specified as being appropriate its estimated mass at that point.

(6) For the purposes of subparagraph (1)(h), if the specified distance required to land with one power unit inoperative from a height of 50 feet at the aerodrome of intended destination exceeds the landing distance available, it shall be sufficient compliance with sub subparagraph (1)(h)(ii) of that clause if an alternate aerodrome which has available the specified landing distance required to land with one power unit inoperative from such a height, is designated in the flight plan.

(7) For the purpose of subparagraph (1)(h), the distance required by the aeroplane to land shall be determined in accordance with subparagraph (1)(g), if it is intended to land at night, or when the cloud ceiling or ground visibility forecast for the estimated time of landing at the aerodrome of the intended destination and at any alternate aerodrome at which it is intended to land in accordance with specified data for short field landing with all power units operating, are less than 500 feet and one nautical mile, respectively.

7. Mass and performance of public transport aeroplanes classified as aeroplanes of performance Group D in their certificates of airworthiness

(1) For the purpose of regulation 45(1), an aeroplane registered in Mauritius, in respect of which there is in force, under these regulations, a certificate of airworthiness in which the aeroplane is designated as being of performance Group D, shall not fly for the purpose of public transport at night or when the cloud ceiling or visibility prevailing at the aerodrome of departure or forecast for the estimated time of landing at the aerodrome at which it is intended to land or at any alternate aerodrome are less than 1,000 feet and one nautical mile, respectively, and shall not fly for the purpose of public transport at any other time unless the mass of the aeroplane at the commencement of the take-off run is such that the following conditions are satisfied –

- (a) that mass does not exceed the maximum take-off mass specified for the altitude and air temperature at the aerodrome at which the take-off is to be made;
- (b) the take-off run required and the take-off distance required specified as being appropriate to –
 - (i) the mass of the aeroplane at the commencement of the take-off run;
 - (ii) the altitude of the aerodrome;
 - (iii) the air temperature at the aerodrome;
 - (iv) the average slope of the surface of the aerodrome in the direction of take-off over the emergency distance available; and
 - (v) not more than 50 per cent of the reported wind component opposite to the direction of take-off or not less than 150 per cent of the reported wind component in the direction of take-off,

do not exceed the take-off run available and the emergency distance available, respectively, at the aerodrome at which the take-off is to be made;

- (c) subject to subparagraphs (2) and (3), the net take-off flight path with all power units operating, specified as being appropriate to –
 - (i) the mass of the aeroplane at the commencement of the take-off run;
 - (ii) the altitude at the aerodrome;
 - (iii) the air temperature at the aerodrome; and
 - (iv) not more than 50 per cent of the reported wind component opposite to the direction of take-off or not less than 150 per cent of the reported wind component in the direction of take-off,

and plotted from a point 50 feet above the end of the take-off distance required at the aerodrome at which the take-off is to be made to the point at which the aeroplane reaches a height of 1,000 feet above the aerodrome, shows that the aeroplane will clear any obstacle in its path by a vertical interval of not less than 35 feet, except that if it is intended that the aeroplane shall change its direction of flight by more than 15 degrees before reaching 1,000 feet, the vertical interval shall be not less than 50 feet during the change of direction;

- (d) subject to subparagraph (4), the aeroplane, at any time after it reaches a height of 1,000 feet above the aerodrome from which take-off is to be made, will, in the meteorological conditions expected for the flight, in the event of any one power unit becoming inoperative at any point on its route or on any planned diversion therefrom, and with the other power unit or power units, if any, operating within the maximum specified continuous power conditions, be capable of continuing the flight at altitudes not less than the relevant minimum altitudes for safe flight stated in, or calculated from the information contained in, the operations manual relating to the aeroplane to a point 1,000 feet above a place at which a safe landing may be made;
- (e) the landing mass of the aeroplane will not exceed the maximum landing mass specified for the altitude and the expected air temperature for the estimated time of landing at the aerodrome at which it is intended to land and at any alternate aerodrome;
- (f) the distance required by the aeroplane to land from a height of 50 feet does not, at the aerodrome at which it is intended to land and at any alternate aerodrome, exceed 70 per cent of the landing distance available on the most suitable runway for a landing in still air conditions, and on the runway that may be required for landing because of the forecast wind conditions; and for the purposes of the runway that may be required for this condition the distance required to land from a height of 50 feet shall be taken to be that specified as being appropriate to –
 - (i) the landing mass;
 - (ii) the altitude at the aerodrome;

- (iii) the temperature in the specified international standard atmosphere appropriate to the altitude at the aerodrome;
- (iv) a level surface in the case of runways usable in both directions, or the average slope of the runway in the case of runways usable in only one direction; and
- (v) still air conditions in the case of the most suitable runway for a landing in still air conditions, or not more than 50 per cent, of the forecast wind component opposite to the direction of landing or not less than 150 per cent of the forecast wind component in the direction of landing in the case of the runway that may be required for the landing because of the forecast wind conditions.

(2) In assessing the ability of the aeroplane to satisfy the condition specified in subparagraph (1)(c), it shall not be assumed to make a change of direction of a radius less than the specified radius of steady turn.

(3) For the purpose of subparagraph (1)(c), an obstacle shall be considered to be in the path of the aeroplane if the distance from the obstacle to the nearest point on the ground below the intended line of flight of the aeroplane does not exceed 75 metres.

(4) In assessing the ability of the aeroplane to satisfy the condition specified at subparagraph (1)(d), it shall not be assumed to be capable of flying at any point on its route at an altitude exceeding the performance ceiling with all power units operating specified as being appropriate to its estimated mass at that point.

8. Mass and performance of public transport aeroplanes classified as aeroplanes of performance Group E in their certificates of airworthiness

(1) For the purpose of regulation 45(1), an aeroplane registered in Mauritius, in respect of which there is in force, under these regulations, a certificate of airworthiness in which the aeroplane is designated as being of performance group E, shall not fly for the purpose of public transport unless the mass of the aeroplane at the commencement of the take-off run is such that the following conditions are satisfied –

- (a) the mass for the altitude and the air temperature at the aerodrome at which the take-off is to be made does not exceed the maximum take-off mass specified as being appropriate to –
 - (i) the mass at which the aeroplane is capable, in the en route configuration and with all power units operating within the specified maximum continuous power conditions, of a rate of climb of 700 feet per minute if it has retractable landing gear and of 500 feet per minute if it has fixed landing gear; and
 - (ii) the mass at which the aeroplane is capable, in the en route configuration and if it is necessary for it to be flown solely by reference to instruments for any period before reaching the minimum altitude for safe flight on the first stage of the route to be flown, stated in, or calculated from the information contained in, the operations manual relating to the aeroplane and, with one power unit inoperative, of a rate of climb of 150 feet per minute;
- (b) the distance required by the aeroplane to attain a height of 50 feet, with all power units operating within the maximum take-off power conditions specified, when multiplied by a factor of 1:33 does not exceed the emergency distance available at the aerodrome at which the take-off is to be made. The distance required by the aeroplane to attain a height of 50 feet shall be that appropriate to –
 - (i) the mass of the aeroplane at the commencement of the take-off run;
 - (ii) the altitude at the aerodrome;
 - (iii) the air temperature at the aerodrome; and
 - (iv) not more than 50 per cent of the reported wind component opposite to the direction of take-off or not less than 150 per cent of the reported wind component in the direction of take-off;
- (c) subject to subparagraph (4), the aeroplane, at any time after it reaches a height of

1,000 feet above the aerodrome from which take-off is to be made, will, in the meteorological conditions expected for the flight, in the event of any one power unit becoming inoperative at any point on its route or on any planned diversion therefrom, and with the other power unit or units, if any, operating within the specified maximum continuous power conditions, be capable of continuing the flight at altitudes not less than the relevant minimum altitude for the safe flight stated in, or calculated from the information contained in, the operations manual relating to the aeroplane to a point 1,000 feet above a place at which a safe landing may be made;

- (d) the landing mass of the aeroplane for the altitude and the expected air temperature for the estimated time of landing at the aerodrome at which it is intended to land and at any alternate aerodrome will not exceed the maximum landing mass specified –
 - (i) at which the aeroplane is capable, in the en route configuration and with all power units operating within the specified maximum continuous power conditions, of a rate of climb of 700 feet per minute if it has retractable landing gear and of 500 feet per minute if it has fixed landing gear; and
 - (ii) at which the aeroplane is capable, in the en route configuration and if it is necessary for it to be flown solely by reference to instruments for any period after leaving the minimum altitude for safe flight on the last stage of the route to be flown, stated in, or calculated from the information contained in, the operations manual relating to the aeroplane and with one power unit inoperative, of a rate of climb of 150 feet per minute;
- (e) the landing distance required does not, at the aerodrome at which it is intended to land and at any alternate aerodrome, exceed 70 per cent of the landing distance available on the most suitable runway for a landing in still air conditions, and for the purposes of this sub paragraph, the distance required to land from a height of 50 feet shall be taken to be that specified as being appropriate to –
 - (i) the landing mass;
 - (ii) the altitude at the aerodrome; and
 - (iii) the temperature in the specified international standard atmosphere appropriate to the altitude at the aerodrome.

(2) Notwithstanding subparagraph (1), subject to subparagraph (3), an aeroplane designated as an aeroplane of performance Group E shall not fly for the purpose of public transport at night or when the cloud ceiling or visibility prevailing at the aerodrome of departure or forecast for the estimated time of landing at the aerodrome at which it is intended to land or at any alternate aerodrome are less than 1,000 feet and one nautical mile, respectively.

(3) The prohibition specified in subparagraph (2), shall not apply if the aeroplane is capable, in the en route configuration and with one power unit inoperative, of a rate of climb of 150 feet per minute.

(4) In assessing the ability of the aeroplane to satisfy the condition specified in subparagraph (1)(c), it shall not be assumed to be capable of flying at any point on its route or planned diversion therefrom at an altitude exceeding that at which it is capable of a rate of climb with all power units operating within the maximum continuous power conditions specified, of 150 feet per minute and, if it is necessary for it to be flown solely by reference to instruments, be capable, with one power unit inoperative, of a rate of climb of 100 feet per minute.

9. Mass and performance of public transport aeroplanes classified as aeroplanes of performance Group F in their certificates of airworthiness

(1) For the purpose of regulation 45(1), an aeroplane registered in Mauritius, in respect of which there is in force, under these regulations, a certificate of airworthiness in which the aeroplane is designated as being of performance Group F, shall not fly for the purpose of public transport unless the mass of the aeroplane at the commencement of the take-off run is such that the following conditions are satisfied –

- (a) that mass does not exceed the maximum take-off mass specified for the altitude and

the air temperature at the aerodrome at which the take-off is to be made;

- (b) the take-off distance required specified as being appropriate to –
- (i) the mass of the aeroplane at the commencement of the take-off run;
 - (ii) the altitude at the aerodrome;
 - (iii) the air temperature at the aerodrome;
 - (iv) the average slope of the surface of the aerodrome in the direction of take-off over the take-off run available; and
 - (v) not more than 50 per cent of the reported wind component opposite to the direction of take-off or not less than 150 per cent of the reported wind component in the direction of take-off,

does not exceed the take-off run available at the aerodrome at which the take-off is to be made;

- (c) subject to subparagraph (3), the aeroplane, at any time after it reaches a height of 1,000 feet above the aerodrome from which take-off is to be made, will, in the meteorological conditions expected for the flight, in the event of any one power unit becoming inoperative at any point on its route or on any planned diversion therefrom, and with the other power unit or power units, if any, operating within the specified maximum continuous power conditions, be capable of continuing the flight at altitudes not less than the relevant minimum altitude for safe flight stated in, or calculated from the information contained in, the operations manual relating to the aeroplane to a point 1,000 feet above –
- (i) in the case of an aeroplane having one power unit, a place at which a safe landing may be made; and
 - (ii) in the case of an aeroplane having 2 or more power units, an aerodrome at which it may comply with sub subparagraph (e);
- (d) the landing mass of the aeroplane will not exceed the maximum landing mass specified for the altitude and the expected air temperature for the estimated time of landing at the aerodrome at which it is intended to land and at any alternate aerodrome;
- (e) the landing distance required does not exceed at the aerodrome at which it is intended to land or at any alternate aerodrome, as the case may be, the landing distance available on the most suitable runway for a landing in still air conditions. For the purposes of this sub subparagraph, the landing distance required shall be that specified as being appropriate to –
- (i) the landing mass;
 - (ii) the altitude at the aerodrome;
 - (iii) the temperature in the specified international standard atmosphere appropriate to the altitude at the aerodrome;
 - (iv) a runway with a level surface; and
 - (v) still air conditions.

(2) Notwithstanding subparagraph (1), an aeroplane with one power unit designated as an aeroplane of performance group F shall not fly, for the purpose of public transport, at night or when the cloud ceiling or visibility prevailing at the aerodrome of departure or forecast for the estimated time of landing at the aerodrome at which it is intended to land or at any alternate aerodrome are less than 1,000 feet and one nautical mile, respectively.

(3) In assessing the ability of the aeroplane to satisfy the conditions specified in subparagraph (1)(c) –

- (a) the aeroplane shall not be assumed to be capable of flying, at any point on its route or on any planned diversion therefrom, at an altitude exceeding that at which it is capable of a gradient of climb, with all power units operating within maximum continuous power conditions specified, of 2 per cent; and

- (b) over those parts of the route or any planned diversion therefrom, where in the meteorological conditions expected for the flight it is expected that the aeroplane will be out of sight of the surface due to cloud cover at or below the relevant minimum safe altitude, the aeroplane shall be required to be capable of a gradient of climb, with one power unit inoperative and with the other power unit or power units operating within the specified maximum continuous power conditions, at the relevant minimum safe altitude, of one per cent.

10. Mass and performance of public transport aeroplanes classified as aeroplanes of performance Group X in their certificates of airworthiness

(1) For the purpose of regulation 45(1), an aeroplane registered in Mauritius, in respect of which there is in force, under these regulations, a certificate of airworthiness designating the aeroplane as being of performance Group X, shall not fly for the purpose of public transport unless the mass of the aeroplane at the commencement of the take-off run is such that the following conditions are satisfied –

- (a) that mass does not exceed the maximum take-off mass specified for the altitude at the aerodrome at which the take-off is to be made, or for the altitude and the air temperature at such aerodrome, as the case may be;
- (b) the minimum effective take-off runway length required, specified as being appropriate to –
 - (i) the mass of the aeroplane at the commencement of the take-off run;
 - (ii) the altitude at the aerodrome;
 - (iii) the air temperature at the time of take-off;
 - (iv) the condition of the surface of the runway from which the take-off will be made;
 - (v) the overall slope of the take-off run available; and
 - (vi) not more than 50 per cent of the reported wind component opposite to the direction of take-off or not less than 150 per cent of the reported wind component in the direction of take-off,

does not exceed the take-off run available at the aerodrome at which the take-off is to be made;

- (c) subject to subparagraph (2), the take-off flight path with one power unit inoperative, specified as being appropriate to –
 - (i) the mass of the aeroplane at the commencement of the take-off run;
 - (ii) the altitude at the aerodrome; and
 - (iii) not more than 50 per cent of the reported wind component opposite to the direction of take-off or not less than 150 per cent of the reported wind component in the direction of take off,

and plotted from a point 50 feet above the end of the minimum effective take-off runway length required at the aerodrome at which the take-off is to be made, shows that the aeroplane will thereafter clear any obstacle in its path by a vertical interval of not less than the greater of 50 feet or 35 feet plus one-hundredth of the distance from the point on the ground below the intended line of flight of the aeroplane nearest to the obstacle to the end of the take-off distance available, measured along the intended line of flight of the aeroplane;

- (d) subject to sub subparagraph (e), the mass of the aeroplane at any point on the route or any planned diversion therefrom, having regard to the fuel and oil expected to be consumed up to that point, shall be such that the aeroplane, with one power unit inoperative and the other power unit or units operating within the maximum continuous power conditions specified, will be capable of a rate of climb of at least $K(V_{so}/100)^2$ feet per minute at an altitude not less than the minimum altitude for safe flight stated in, or calculated from the information contained in, the operations manual relating to the aeroplane, where V_{so} is in knots and K has the value of 797-1060/N, N being the

number of power units installed;

- (e) as an alternative to subparagraph (3)(d), the aeroplane may be flown at an altitude from which, in the event of failure of one power unit, it is capable of reaching an aerodrome where a landing may be made in accordance with sub subparagraph (h) relating to an alternate aerodrome. In that case the mass of the aeroplane shall be such that, with the remaining power unit or units operating within the maximum continuous power conditions specified, it is capable of maintaining a minimum altitude on the route to such aerodrome of 2,000 feet above all obstacles within 10 nautical miles on every side of the intended track;
- (f) an aeroplane having 4 power units shall, if any 2 power units become inoperative at any point along the route or any planned diversion therefrom, being a point more than 90 minutes flying time, assuming all power units to be operating, from the nearest aerodrome at which a landing may be made in compliance with sub subparagraph (h) relating to an alternate aerodrome, be capable of continuing the flight at an altitude of not less than 1,000 feet above ground level to a point above that aerodrome. In assessing the ability of the aeroplane to satisfy this condition, it shall be assumed that the remaining power units will operate within the specified maximum continuous power conditions, and account shall be taken of the temperature and wind conditions expected for the flight;
- (g) the landing mass of the aeroplane will not exceed the maximum landing mass specified for the altitude at the aerodrome at which it is intended to land and at any alternate aerodrome;
- (h) the required landing runway, lengths respectively specified as being appropriate to the aerodrome of intended destination, and the alternate aerodromes do not exceed, at the aerodrome at which it is intended to land or at any alternate aerodrome, as the case may be, the landing distance available on the most suitable runway for landing in still air conditions, and the runway that may be required for landing because of the forecast wind conditions, the required landing runway lengths being taken to be those specified as being appropriate to –
 - (i) the landing mass;
 - (ii) the altitude at the aerodrome;
 - (iii) still air conditions in the case of the most suitable runway for a landing in still air conditions; and
 - (iv) not more than 50 per cent of the forecast wind component opposite to the direction of landing or not less than 150 per cent of the forecast wind component in the direction of landing in the case of the runway that may be required for landing because of the forecast wind conditions.

(2) (a) For the purpose of subparagraph (1)(c), an obstacle shall be considered to be in the path of the aeroplane if the distance from the obstacle to the nearest point on the ground below the intended line of flight does not exceed –

- (i) a distance of 60 metres plus half the wing span of the aeroplane plus one-eighth of the distance from such point to the end of the take-off distance available measured along the intended line of flight; or
- (ii) 900 metres,

whichever is the lesser.

(b) In assessing the ability of the aeroplane to satisfy the condition specified in subparagraph (1)(c), insofar as it relates to flight path, it shall not be assumed to make a change of direction of a radius less than the radius of steady turn corresponding to an angle of bank of 15 degrees.

(3) For the purpose of subparagraph (2)(e), where the operator of the aeroplane is satisfied, taking into account the navigation aids which may be used or by the aeroplane on the route, that the commander of the aeroplane will be able to maintain his intended track on that route within a margin of

5 nautical miles, this subparagraph shall apply as if 5 nautical miles were substituted therein for 10 nautical miles and –

- (a) the rate of climb, specified for the appropriate mass and altitude, used in calculating the flight path shall be reduced by an amount equal to $K(V_{so}/100)^2$ feet per minute;
- (b) the aeroplane shall comply with the climb requirements of subparagraph (1)(c) at 1,000 feet above the chosen aerodrome;
- (c) account shall be taken of the effect of wind and temperature on the flight path; and
- (d) the mass of the aeroplane may be assumed to be progressively reduced by normal consumption of fuel and oil.

11. Noise and vibration caused by aircraft on aerodromes

For the purpose of any enactment relating to noise and vibration, no noise or vibration may be caused by aircraft, including military aircraft, on a Government aerodrome, an aerodrome owned or managed by the Authority, a licensed aerodrome or an aerodrome at which the manufacture, repair or maintenance of aircraft is carried out by persons carrying on business as manufacturers or repairers of aircraft, except where, whether in the course of the manufacture of the aircraft or otherwise –

- (a) the aircraft is taking off or landing;
- (b) the aircraft is moving on the ground or water; or
- (c) the engines are being operated in the aircraft for the purpose of –
 - (i) ensuring their satisfactory performance;
 - (ii) bringing them to a proper temperature in preparation for, or at the end of, a flight; or
 - (iii) ensuring that the instruments, accessories or other components of the aircraft are in a satisfactory condition.

12. Aeroplanes flying for the purpose of public transport of passengers – aerodrome facilities for approach to landing and landing

(1) This paragraph shall apply to every aeroplane, registered in Mauritius, engaged on a flight for the purpose of public transport of passengers on a scheduled journey and having a maximum total authorised mass which is more than 5,700 kilogrammes and engaged on such a flight otherwise than on a scheduled journey.

(2) For the purpose of regulation 43(1)(c), the following manning and equipment are prescribed in relation to aerodromes intended to be used for landing or as an alternate aerodrome by aircraft covered by subparagraph (1) –

- (a) air traffic control service or aerodrome flight information service, including the reporting to aircraft of the current meteorological conditions at the aerodrome;
- (b) very high frequency radiotelephony;
- (c) at least one of the following radio navigation aids, at the aerodrome or elsewhere, and in every case, for the purpose of assisting the pilot in locating the aerodrome and making an approach to landing there –
 - (i) radio direction finding equipment utilising emissions in the very high frequency bands;
 - (ii) a non-directional radio beacon transmitting signals in the low or medium frequency bands;
 - (iii) very high frequency omni-directional radio range;
 - (iv) radio navigation land stations forming part of the Decca radio navigation system;
 - (v) radar equipment.

(3) It shall be sufficient if the equipment specified at subparagraph (2)(c) is provided even if for the time being it is not in operation.

(4) An aircraft covered by subparagraph (1) shall not land or make an approach to landing at any aerodrome unless services and equipment according to subparagraph (2) are provided and are in

operation at that aerodrome, and may be used by that aircraft, and, in the case of the navigation aids specified in subparagraph (2)(c)(i) to (iv), instructions and procedures for the use of the aid are included in the operations manual relating to the aircraft. A person shall not contravene this paragraph if he proves that –

- (a) for the time being, use could not be made of the radio navigation aids provided under subparagraph (2)(c) whether by reason of those aids not being in operation or the unserviceability of equipment in the aircraft itself; and
- (b) the approach to landing was made in accordance with instructions and procedures appropriate to that circumstance and included in the operations manual.

13. Pilots maintenance – prescribed repairs or replacements

For the purpose of regulation 19(4), the following repairs or replacements are prescribed –

- (a) replacement of landing gear tyres, landing skids or skid shoes;
- (b) replacement of elastic shock absorber cord units on landing gear where special tools are not required;
- (c) replacement of defective safety wiring or split pins, excluding those in engine, transmission, flight control and rotor systems;
- (d) patch-repairs to fabric not requiring rib stitching or the removal of structural parts or control surfaces, if the repairs do not cover up structural damage and do not include repairs to rotor blades;
- (e) repairs to upholstery and decorative furnishing of the cabin or cockpit interior when repair does not require dismantling of any structure or operating system or interfere with an operating system or affect the structure of the aircraft;
- (f) repairs, not requiring welding, to fairings, non-structural cover plates and cowlings;
- (g) replacement of side windows where that work does not interfere with the structure or with any operating system;
- (h) replacement of safety belts or safety harness;
- (i) replacement of seats or seat parts not involving dismantling of any structure or operating system;
- (j) replacement of bulbs, reflectors, glasses, lenses or lights;
- (k) replacement of any cowling not requiring the removal of the propeller, rotors or disconnection of engine or flight controls;
- (l) replacement of unserviceable sparking plugs;
- (m) replacement of batteries;
- (n) replacement of wings, tail surfaces and controls, the attachments of which are designed to provide for assembly immediately before every flight and dismantling after every flight;
- (o) replacement of main rotor blades that are designed for removal where special tools are not required;
- (p) replacement of generator and fan belts designed for removal where special tools are not required;
- (q) replacement of VHF communication equipment, being equipment which is not combined with navigation equipment.

14. Mandatory reporting – reportable occurrences, time and manner of reporting and information to be reported

(1) For the purpose of regulations 2 and 128(1), the occurrences which shall be regarded as reportable occurrences are those –

- (a) (i) involving damage to an aircraft;
- (ii) involving injury to a person;

- (iii) involving the impairment, during a flight, of the capacity of a member of the flight crew of an aircraft to undertake the functions to which his licence relates;
 - (iv) involving the use in flight of any procedures taken for the purpose of overcoming an emergency;
 - (v) involving the failure of an aircraft system or any equipment of an aircraft;
 - (vi) arising from the control of an aircraft in flight by its flight crew;
 - (vii) arising from failure or inadequacy of facilities or services on the ground used or intended to be used for the purposes of or in connection with the operation of aircraft;
 - (viii) arising from the loading or carriage of passengers, cargo, including mail, or fuel; and
- (b) which are not referred to in sub subparagraph (a) but which, in the opinion of a person referred to in regulation 128, constitute an occurrence endangering, or which if not corrected would endanger, the safety of an aircraft, its occupants or any other person.

(2) For the purpose of this paragraph –

“aircraft system” includes the flight control, power plant, fuel, hydraulic, pneumatic, pressurisation, electrical, navigation and any other system of the aircraft.

(3) For the purpose of regulation 128, a report containing the information referred to in subparagraph (4) shall be despatched in writing, or in such other form as the Authority may approve, and by the quickest available means to the Authority within 96 hours of the reportable occurrence coming to the knowledge of the person making the report.

(4) A report under regulation 128 shall, as far as possible, contain the following information –

- (a) the type, series and registration marks of the aircraft concerned;
- (b) the name of the operator of the aircraft;
- (c) the date of the reportable occurrence;
- (d) if the person making the report has instituted an investigation into the reportable occurrence, whether or not this has been completed;
- (e) a description of the reportable occurrence, including its effects and any other relevant information;
- (f) in the case of a reportable occurrence which occurs during flight –
 - (i) the time of occurrence in UTC;
 - (ii) the last point of departure and the next point of intended landing of the aircraft at that time; and
 - (iii) the geographical position of the aircraft at that time;
- (g) in the case of a defect in or malfunctioning of an aircraft or any part or equipment of an aircraft, the name of the manufacturer of the aircraft, part or equipment, as the case may be, and, where appropriate, the part number and modification standard of the part or equipment and its location on the aircraft;
- (h) the signature and name, in capital letters, of the person making the report, the name of his employer and the capacity in which he acts for that employer; and
- (i) in the case of a report made by the commander of an aircraft or a person referred to in regulation 128(1)(c) or (d), the address or telephone number at which communications shall be made to him, if different from that of his place of employment.

15. Mass and performance of public transport helicopters classified as helicopters of performance Group A in their certificate of airworthiness

For the purpose of regulation 45(1), a helicopter registered in Mauritius, in respect of which there is in force, under these regulations, a certificate of airworthiness in which the helicopter is designated as being of performance group A, shall not fly for the purpose of public transport unless the mass of

the helicopter at the commencement of take-off is such that the following conditions are satisfied –

- (1) the mass does not exceed the maximum take-off mass specified for the altitude and the air temperature at the site from which the take-off is to be made;
- (2) the landing mass of the helicopter will not exceed the maximum landing mass specified for the altitude and the expected air temperature for the estimated time of landing at the site at which it is intended to land and at any alternate site.

16. Mass and performance of public transport helicopters classified as helicopters of performance Group A (Restricted) in their certificate of airworthiness

For the purpose of regulation 45(1), a helicopter registered in Mauritius, in respect of which there is in force, under these regulations, a certificate of airworthiness in which the helicopter is designated as being of performance Group A (Restricted), shall not fly for the purpose of public transport when the cloud ceiling or visibility prevailing at the departure site and forecast for the estimated time of landing at the site at which it is intended to land and at any alternate site are less than 500 feet and 1,000 metres respectively and shall not fly for the purpose of public transport at any other time unless the mass of the helicopter at the commencement of take-off is such that the following conditions are satisfied –

- (a) the mass does not exceed the maximum take-off mass specified for the altitude and the air temperature at the site from which the take-off is to be made;
- (b) the landing mass of the helicopter does not exceed the maximum landing mass specified for the altitude and the expected air temperature for the estimated time of landing at the site at which it is intended to land and at any alternate site.

17. Mass and performance of public transport helicopters classified as helicopters of performance Group B in their certificate of airworthiness

For the purpose of regulation 45(1), a helicopter registered in Mauritius, in respect of which there is in force, under these regulations, a certificate of airworthiness in which the helicopter is designated as being of performance Group B, shall not fly for the purpose of public transport at night or out of sight of the surface or when the cloud ceiling or visibility prevailing at the departure site and forecast for the estimated time of landing at the site at which it is intended to land are less than 600 feet and 1,000 metres, respectively, and shall not fly for the purpose of public transport at any other time unless the mass of the helicopter at the commencement of take-off is such that the following conditions are satisfied –

- (a) the mass does not exceed the maximum take-off mass specified for the altitude and the air temperature at the site from which the take-off is to be made;
- (b) the landing mass of the helicopter will not exceed the maximum landing mass specified for the altitude and the expected air temperature for the estimated time of landing at the site at which it is intended to land and at any alternate site.

18. Minimum navigation performance specifications – prescribed airspace and navigation performance capability

(1) For the purpose of regulation 53, the following navigation performance capability is hereby prescribed, that is, a capability to ensure that –

- (a) the standard deviation of lateral errors in the track of the aircraft is not more than 6.3 nautical miles;
- (b) the proportion of the flight time of the aircraft during which the actual track of the aircraft is not less than 30 nautical miles off the track along which it has been given an air traffic control clearance to fly is less than 5.3×10^{-4} ; and
- (c) the proportion of the flight time of the aircraft during which the actual track of the aircraft is not less than 50 nautical miles and not more than 70 nautical miles off the track along which it has been given an air traffic control clearance to fly is less than 13×10^{-5} .

(2) For the purposes of regulation 54, the following height keeping performance capability is hereby prescribed, that is, a capability to ensure that –

- (a) altimetry system error shall be in compliance with provision of ICAO Document 7030/4-NAT Part 1 rules of the Air, Air Traffic Services and Search and Rescue (ICAO

Regional Procedures); and

- (b) (i) in respect of aircraft first registered in a Contracting State on or after 1 January 1997, altitude may be automatically controlled within a tolerance band of ± 65 feet;
- (ii) in respect of aircraft first registered in a Contracting State before 1st January 1997, altitude may be automatically controlled within a tolerance band of ± 130 feet.

(3) For the purposes of regulation 53, the following airspace is hereby prescribed as North Atlantic Minimum Navigation Performance Specification airspace, that is, the airspace from flight level 285 to flight level 420 within the area defined by rhumb lines joining, successively, the following points

–
N3410.00 W01748.00 N8200.00 E03000.00 N4500.00 W05300.00;
N3630.00 W01500.00 North Pole N4336.00 W06000.00;
N4200.00 W01500.00 N8200.00 W06000.00 N4152.00 W06700.00;
N4300.00 W01300.00 N7800.00 W07500.00 N3900.00 W06700.00;
N4500.00 W01300.00 N7600.00 W07600.00 N3835.00 W06853.00;
N4500.00 W00800.00 N6500.00 W05745.00 N3830.00 W06915.00;
N5100.00 W00800.00 N6500.00 W06000.00 N3830.00 W06000.00;
N5100.00 W01500.00 N6400.00 W06300.00 N2700.00 W06000.00;
N5400.00 W01500.00 N6100.00 W06300.00 N2700.00 W02500.00;
N5434.00 W01000.00 N5700.00 W05900.00 N3000.00 W02500.00;
N6100.00 W01000.00 N5300.00 W05400.00 N3000.00 W02000.00;
N6100.00 W00000.00 N4900.00 W05100.00 N3139.00 W01725.00;
N8200.00 W00000.00 N4500.00 W05100.00,

thence by that part of the arc of a circle radius 100 nautical miles centered on N3304.00 W01621.00 to N3410.00 W01748.00.

PART II – AEROPLANES REFERRED TO IN PARAGRAPH 4 OF PART I

Sub-Part A – General

The conditions set out in Sub-part B shall apply to every aeroplane referred to in paragraph 4 of Part I as follows –

- (a) Conditions (1) and (2) shall apply to every aeroplane;
- (b) Conditions (3) to (10) shall apply to an aeroplane –
 - (i) of which the maximum total authorised mass exceeds 5,700 kilogrammes; or
 - (ii) of which the total authorised mass does not exceed 5,700 kilogrammes and which does not satisfy subparagraph (a) or (b) of Condition (1);
- (c) Conditions (11) to (18) shall apply to an aeroplane of which the maximum total authorised mass does not exceed 5,700 kilogrammes and which satisfies subparagraph (a) or (b) of Condition (1).

Sub-Part B – Conditions

- (1) One or more of the following is satisfied –
 - (a) the wing loading of the aeroplane shall not exceed 10 kilogrammes per square foot; or
 - (b) the stalling speed of the aeroplane in the landing configuration does not exceed 60 knots; or
 - (c) the aeroplane, with any one of its power units inoperative and the remaining power unit or units operating within the maximum continuous power conditions specified, is capable of a gradient of climb of at least one in 200 at an altitude of 5,000 feet in the specified international standard atmosphere.

(2) The mass of the aeroplane at the commencement of the take-off run does not exceed the maximum take-off mass, if any, specified for the altitude and the air temperature at the aerodrome at which the take-off is to be made.

(3) (a) The distance required by the aeroplane to attain a height of 50 feet, with all power units operating within the maximum take-off power conditions specified does not exceed the take-off run available at the aerodrome at which the take-off is to be made.

(b) The distance required by the aeroplane to attain a height of 50 feet with all power units operating within the maximum take-off power conditions specified, when multiplied by a factor of 1.33 for aeroplanes having 2 power units or 1.18 for aeroplanes having 4 power units, does not exceed the emergency distance available at the aerodrome at which the take-off is to be made.

(c) For the purpose of sub subparagraphs (a) and (b), the distance required by the aeroplane to attain a height of 50 feet shall be that appropriate to –

- (i) the mass of the aeroplane at the commencement of the take-off run;
- (ii) the altitude at the aerodrome;
- (iii) the air temperature at the aerodrome;
- (iv) the condition of the surface of the runway from which the take-off will be made;
- (v) the slope of the surface of the aerodrome in the direction of take-off over the take-off run available and the emergency distance available, respectively; and
- (vi) not more than 50 per cent of the reported wind component opposite to the direction of take-off or not less than 150 per cent of the reported wind component in the direction of take-off.

(4) (a) The take-off flight path with one power unit inoperative and the remaining power unit or units operating within the maximum take-off power conditions specified, appropriate to –

- (i) the mass of the aeroplane at the commencement of the take-off run;
- (ii) the altitude at the aerodrome;
- (iii) the air temperature at the aerodrome; and
- (iv) not more than 50 per cent of the reported wind component opposite to the direction of take-off or not less than 150 per cent of the reported wind component in the direction of take-off,

and plotted from a point 50 feet above the end of the appropriate factored distance required for take-off under subparagraph (b) of Condition (3) at the aerodrome at which the take-off is to be made, shows that the aeroplane will clear any obstacle in its path by a vertical interval of at least 35 feet except that if it is intended that an aeroplane shall change its direction by more than 15 degrees, the vertical interval shall be not less than 50 feet during the change of direction.

(b) For the purpose of sub subparagraph (a), an obstacle shall be considered to be in the path of the aeroplane if the distance from the obstacle to the nearest point on the ground below the intended line of flight does not exceed –

- (i) a distance of 60 metres plus half the wing span of the aeroplane, plus one-eighth of the distance from such point to the end of the take-off distance available, measured along the intended line of flight; or
- (ii) 900 metres,

whichever is the lesser.

(c) In assessing the ability of the aeroplane to satisfy this condition, it shall not be assumed to make a change of direction of a radius less than a radius of steady turn corresponding to an angle of bank of 15 degrees.

(5) (a) The aeroplane shall, in the meteorological conditions expected for the flight, in the event of any one power unit becoming inoperative at any point on its route or on any planned diversion therefrom and with the other power unit or units, if any, operating within the maximum continuous power conditions specified, be capable of continuing the flight, clearing obstacles within 10 nautical

miles on every side of the intended track by a vertical interval of –

- (i) at least 1,000 feet when the gradient of the flight path is not less than zero; or
- (ii) at least 2,000 feet when the gradient of the flight path is less than zero,

to an aerodrome at which it may comply with condition (7), and on arrival over such aerodrome the flight path shall have a gradient of not less than zero at 1,500 feet above the aerodrome.

(b) For the purpose of this condition the gradient of climb of the aeroplane shall be taken to be one per cent less than that specified.

(6) The aeroplane shall, in the meteorological conditions expected for the flight, at any point on its route or on any planned diversion therefrom, be capable of climbing at a gradient of at least one in 50, with all power units operating within the maximum continuous power conditions specified at the following altitudes –

- (a) the minimum altitudes for safe flight on every stage of the route to be flown or of any planned diversion therefrom specified in, or calculated from the information contained in, the operations manual relating to the aeroplane; and
- (b) the minimum altitudes necessary for compliance with condition (3) and (5), as appropriate.

(7) Where on the route to be flown or any planned diversion therefrom, the aeroplane shall be engaged in a flight over water during which, at any point, it may be more than 90 minutes flying time in still air from the nearest shore, it shall, in the event of 2 power units becoming inoperative during such time and with the other power unit or units, if any, operating within the maximum continuous power conditions specified, be capable of continuing the flight having regard to the meteorological conditions expected for the flight, clearing all obstacles within 10 nautical miles on every side of the intended track by a vertical interval of at least 1,000 feet, to an aerodrome at which a safe landing can be made.

(8) The landing mass of the aeroplane shall not exceed the maximum landing mass, if any, specified for the altitude and the expected air temperature for the estimated time of landing at the aerodrome at which it is intended to land and at any alternate aerodrome.

(9) (a) The distance required by the aeroplane to land from a height of 50 feet, at the aerodrome at which it is intended to land does not exceed 60 per cent of the landing distance available on –

- (i) the most suitable runway for a landing in still air conditions; and
- (ii) the runway that may be required for landing because of the forecast wind conditions.

(b) Where an alternate aerodrome is designated in the flight plan, the landing distance required at the aerodrome at which it is intended to land shall not exceed 70 per cent of that available on the runway and the distance required to land from a height of 50 feet shall be taken to be that appropriate to –

- (i) the landing mass;
- (ii) the altitude at the aerodrome;
- (iii) the temperature in the specified international standard atmosphere appropriate to the altitude at the aerodrome;
- (iv) (A) a level surface in the case of runways usable in both directions;
(B) the average slope of the runway in the case of runways usable in only one direction; and
- (v) (A) still air conditions in the case of the most suitable runway for a landing in still air conditions; and
(B) not more than 50 per cent of the forecast wind component opposite to the direction of landing or not less than 150 per cent of the forecast wind component in the direction of landing in the case of the runway that may be required for landing because of the forecast wind conditions.

(10) (a) The distance required by the aeroplane to land from a height of 50 feet does not, at any

alternate aerodrome, exceed 70 per cent of the landing distance available on –

- (i) the most suitable runway for a landing in still air conditions; and
- (ii) the runway that may be required for landing because of the forecast wind conditions.

(b) For the purpose of this subparagraph, the distance required to land from a height of 50 feet shall be determined in the manner provided in Condition (9).

(11) Where the aeroplane is engaged on a flight at night or when the cloud ceiling or visibility prevailing at the aerodrome of departure or forecast for the estimated time of landing at the aerodrome at which it is intended to land or at any alternate aerodrome is less than 1,000 feet and one nautical mile, respectively, it shall, with any one of its power units inoperative and the remaining power unit or units, if any, operating within the maximum continuous power conditions specified, be capable of climbing at a gradient of at least one in 200 at an altitude of 2,500 feet in the specified international standard atmosphere.

(12) (a) The distance required by the aeroplane to attain a height of 50 feet with all power units operating within the maximum take-off power conditions specified, does not exceed the take-off run available at the aerodrome at which the take-off is to be made.

(b) The distance required by the aeroplane to attain a height of 50 feet, with all power units operating within the maximum take-off power conditions specified, when multiplied by a factor of 1.33 does not exceed the emergency distance available at the aerodrome at which the take-off is to be made.

(c) For the purposes of subparagraphs (a) and (b), the distance required by the aeroplane to attain a height of 50 feet shall be that appropriate to –

- (i) the mass of the aeroplane at the commencement of the take-off run;
- (ii) the altitude at the aerodrome;
- (iii) the temperature in the specified international standard atmosphere appropriate to the altitude at the aerodrome or, if greater, the air temperature at the aerodrome less 15 degrees centigrade, whichever is the greater;
- (iv) the slope of the surface of the aerodrome in the direction of take-off over the take-off run available and the emergency distance available respectively; and
- (v) not more than 50 per cent of the reported wind component opposite to the direction of take-off or not less than 150 per cent of the reported wind component in the direction of take-off.

(13) The take-off flight path, with all power units operating within the maximum take-off power conditions specified, appropriate to –

- (a) the mass of the aeroplane at the commencement of the take-off run;
- (b) the altitude at the aerodrome;
- (c) the temperature in the specified international standard atmosphere appropriate to the altitude at the aerodrome, or, if greater, the air temperature at the aerodrome less 15 degrees centigrade; and
- (d) not more than 50 per cent of the reported wind component opposite to the direction of take-off or not less than 150 per cent of the reported wind component in the direction of take off,

and plotted from a point 50 feet above the end of the factored distance required for take-off under subparagraph (b) of condition (13), at the aerodrome at which the take-off is to be made, shows that the aeroplane shall clear any obstacle lying within 60 metres plus half the wing span of the aeroplane on every side of its path by a vertical interval of at least 35 feet. In assessing the ability of the aeroplane to comply with this subparagraph it shall not be assumed to make a change of direction of a radius less than a radius of steady turn corresponding to an angle of bank of 15 degrees.

(14) The aeroplane shall, in the meteorological conditions expected for the flight, in the event of any power unit becoming inoperative at any point on its route or planned diversion therefrom and with

the other power units, if any, operating within the maximum continuous power conditions specified, be capable of continuing the flight to reach a point above a place at which a safe landing may be made at a suitable height for such landing.

(15) The aeroplane shall, in the meteorological conditions expected for the flight, at any point on its route or planned diversion therefrom, be capable of climbing at a gradient of at least one in 50, with all power units operating within the maximum continuous power conditions specified at the following altitudes –

- (a) the minimum altitudes for safe flight on every stage of the route to be flown or on any planned diversion therefrom specified in, or calculated from, the information contained in the operations manual relating to the aeroplane; and
- (b) the minimum altitudes necessary to comply with subparagraph (12).

(16) If on the route to be flown or any planned diversion therefrom, the aeroplane will be engaged on a flight over water during which, at any point, it may be more than 30 minutes flying time in still air from the nearest shore, it will, in the event of one power unit becoming inoperative during such time and with the other power unit or units, if any, operating within the maximum continuous power conditions specified, be capable of climbing at a gradient of at least one in 200 at an altitude of 5,000 feet in the specified international standard atmosphere.

(17) The landing mass of the aeroplane shall not exceed the maximum landing mass, if any, specified for the altitude and the expected air temperature for the estimated time of landing at the aerodrome at which it is intended to land and at any alternate aerodrome.

(18) The distance required by the aeroplane to land from a height of 50 feet does not, at the aerodrome at which it is intended to land and at any alternate aerodrome, exceed 70 per cent, or, if a visual approach and landing will be possible in the meteorological conditions forecast for the estimated time of landing, 80 per cent of the landing distance available on –

- (a) the most suitable runway for a landing in still air conditions; and
- (b) the runway that may be required for landing because of the forecast wind conditions,

the distance required to land from a height of 50 feet being taken to be that appropriate to –

- (i) the landing mass;
- (ii) the altitude at the aerodrome;
- (iii) the temperature in the specified international standard atmosphere appropriate to the altitude at the aerodrome;
- (iv) (A) a level surface in the case of runways usable in only one direction; or
(B) the average slope of the runway in the case of runways usable in only one direction; and
- (v) (A) still air conditions in the case of the most suitable runway for a landing in still air conditions; or
(B) not more than 50 per cent of the forecast wind component opposite to the direction of landing or not less than 150 per cent of the forecast wind component in the direction of landing in the case of the runway that may be required for landing because of the forecast wind conditions.

EIGHTH SCHEDULE

[Regulations 19(5), 23, 41(8) and 59]

AIRCRAFT EQUIPMENT

1. An aircraft registered in Mauritius, which is of a description specified in the first column of the table set out in paragraph 4, shall be provided, when flying in the circumstances specified in the second column of that table, with the scales of equipment respectively indicated in the third column of the table and specified in paragraph 5. If the aircraft is flying in a combination of the circumstances

specified in the second column of the table, the scales of equipment shall not on that account be required to be duplicated.

2. The equipment carried in an aircraft as being necessary for the airworthiness of the aircraft shall be taken into account in determining whether this Schedule is complied with in respect of that aircraft.

3. The following items of equipment shall not be required to be of a type approved by the Authority –

- (a) equipment referred to in Scale A(b);
- (b) first aid equipment and handbook, referred to in Scale A;
- (c) timepieces, referred to in Scale F;
- (d) torches, referred to in Scales G, H, K and Z;
- (e) whistles, referred to in Scale H;
- (f) sea anchors, referred to in Scales J and K;
- (g) rocket signals, referred to in Scale J;
- (h) equipment for mooring anchoring or manoeuvring aircraft on the water, referred to in Scale J;
- (i) paddles, referred to in Scales K;
- (j) food and water, referred to in Scales K, U and V;
- (k) first aid equipment referred to in Scales K, U and V;
- (l) stoves, cooking utensils, snow shovels, ice saws, sleeping bags and Arctic suits, referred to in Scale V;
- (m) megaphones, referred to in Scales Y.

4. TABLE

Description of Aircraft	Circumstances of flight
(1) Gliders	(1) flying for purposes other than public transport or aerial work, and when flying by night
	(2) flying for the purpose of public transport or aerial work, and when –
	(a) flying by night
	(b) carrying out aerobatic manoeuvres
(2) Aeroplanes	(1) flying for purposes other than public transport, and when –
	(a) flying by night
	(b) flying under Instrument Flight Rules –
	(i) outside controlled airspace
	(ii) within Class A, B or C airspace

	(iii) within Class D and E airspace
	(c) carrying out aerobatic manoeuvres
	(2) flying for the purpose of public transport, and –
	(a) when flying under Instrument Flight Rules except flights outside controlled airspace in the case of aeroplanes having a maximum total authorised weight of not more than 1,150 kilogrammes
	(b) when flying by night; and in the case of aeroplanes of which the maximum total authorised weight of not less than 1,150 kilogrammes
	(c) when flying over water beyond gliding distance from land;
	(d) on all flights on which, in the event of any emergency occurring during the take-off or during the landing at the intended destination or any likely alternate destination, it is reasonably possible that the aeroplane would be forced to land onto water;
	(e) when flying over water –
	(i) in the case of an aeroplane –
	(A) classified in its certificate of airworthiness as being of performance group A, C or X; or
	(B) having no performance group classification in its certificate of airworthiness and of such a weight and performance that with any one of its power units inoperative and the remaining power unit or units operating within the maximum continuous power conditions specified in the certificate by the Authority it is capable of a gradient of climb of at least one in 200 at an altitude of 5,000 feet in the International Standard Atmosphere specified in or ascertainable by reference to the certificate of airworthiness in force in respect of that aircraft,
	when more than 400 nautical miles or more than 90 minute flying time one from the nearest aerodrome at which an emergency landing can be made

	(ii) in the case of all other aeroplanes, when more than 30 minutes flying time one from such an aerodrome;
	(f) on all flights which involve manoeuvres on water
	(g) when flying at a height of 10,000 ft or more above mean sea level –
	(i) having a certificate of airworthiness first issued, whether in Mauritius or elsewhere, before 1 January 1989
	(ii) having a certificate of airworthiness first issued, whether in Mauritius or elsewhere, on or after 1 January 1989
	(h) on flights when the weather reports or forecasts available at the aerodrome at the time of departure indicate that conditions favouring ice formation are likely to be met
	(i) when carrying out aerobatic manoeuvres
	(j) on all flights on which the aircraft carries a flight crew of more than one person
	(k) on all flights for the purpose of the public transport of passengers
	(l) on all flights by a pressurised aircraft
	(m) when flying over substantially uninhabited land areas where, in the event of an emergency landing, tropical conditions are likely to be met
	(n) when flying over substantially uninhabited land or other areas where, in the event of any emergency landing, polar conditions are likely to be met
	(o) when flying at an altitude of more than 49,000 ft
(3) Turbine jet aeroplanes having a maximum total authorised mass of not less than 5,700 kilogrammes or pressurised aircraft having a maximum total authorised mass of not less than 11,400 kilogrammes	when flying for the purpose of public transport
(4) Turbine engined aeroplanes having a maximum total authorised mass of not less than 5,700 kilogrammes and piston engined aeroplanes having a maximum total authorised mass of not less than 27,000 kilogrammes	

except for such aeroplanes falling within paragraphs (5) or (6) –	
(a) which are operated by an air transport undertaking under a certificate of airworthiness in the Transport Category (Passenger) or the Transport Category (Cargo);or	when flying on any flight
(b) in respect of which application has been made and not withdrawn or refused for such a certificate, and which fly under the 'A Conditions' or a certificate of airworthiness in the Special Category	when flying on any flight
(5) Aeroplanes in respect of which there is in force a certificate of airworthiness in the Transport category (Passenger) or Transport Category (Cargo) and aeroplanes in respect of which application has been made, and not withdrawn or refused, for such a certificate of airworthiness and which fly under the 'A Conditions' or there is in force a certificate of airworthiness in the Special Category except for such aeroplanes falling within paragraph (6) –	
(a) which conform to a type first issued with a type certificate, whether in Mauritius or elsewhere, on or after 1 April 1971 and have a maximum total authorised mass of not less than 5,700 kilogrammes, nor more than 11,400 kilogrammes	when flying on any flight
(b) which conform to a type first issued with a type certificate (whether in Mauritius or elsewhere) on or after 1 April 1971 and have a maximum total authorised mass of not less than 11,400 kilogrammes nor more than 27,000 kilogrammes	when flying on any flight
(c) which conform to a type first issued with a type certificate, whether in Mauritius or elsewhere, on or after 1 April 1971 and have a maximum total authorised mass of not less than 27, 000 kilogrammes nor more than 230,000 kilogrammes; or	when flying on any flight
(d) which conform to a type first issued with a type certificate in the Mauritius on or after 1 January 1970 and have a maximum total	when flying on any flight

<p>authorised mass of not less than 230,000 kilogrammes</p>	
<p>(6) Aeroplanes in respect of which there is in force a certificate of airworthiness in the Transport Category (Passenger) or Transport Category (Cargo) and aeroplanes in respect of which application has been made, and not withdrawn or refused, for such a certificate of airworthiness and which fly under 'A Conditions', or there is in force a certificate of airworthiness in the Special Category –</p>	
<p>(a) for which an individual certificate of airworthiness was first issued (whether in Mauritius or elsewhere) on or after 1 June 1990 and which have a maximum total authorised mass of not more than 5,700 kilogrammes, are powered by 2 or more turbine engines and are certified to carry more than 9 passengers</p>	<p>when flying on any flight</p>
<p>(b) for which an individual certificate of airworthiness was first issued, whether in Mauritius or elsewhere, on or after 1 June 1990 and which have a maximum total authorised mass of not less than 5,700 kilogrammes nor more than 27,000 kilogrammes; or</p>	<p>when flying on any flight</p>
<p>(c) for which an individual certificate of airworthiness was first issued, whether in Mauritius or elsewhere, on or after 1 June 1990 and which have a maximum total authorised mass of not less than 27,000 kilogrammes</p>	<p>when flying on any flight</p>
<p>(7) Aeroplanes in respect of which there is in force a certificate of airworthiness in the Aerial Work or Private Category and for which an individual certificate of airworthiness was first issued, whether in Mauritius or elsewhere, on or after 1 June 1990 and which have a maximum total authorised mass of not less than 27,000 kilogrammes</p>	<p>when flying on any flight</p>
<p>(8) Aeroplanes –</p>	
<p>(a) which conform to a type first issued with a type certificate, whether in Mauritius or elsewhere, on or after 1 April 1971 and having a maximum total authorised mass of not less than 27,000 kilogrammes and in respect of</p>	<p>when flying on any flight</p>

<p>which there is in force a certificate of airworthiness in the Transport Category (Passenger) or the Transport Category (Cargo)</p>	
<p>(b) which conform to a type first issued with a type certificate in Mauritius on or after 1 January 1970 and have a maximum total authorised mass of not less than 230,000 kilogrammes and in respect of which there is in force such a certificate of airworthiness; or</p>	<p>when flying on any flight</p>
<p>(c) having a maximum total authorised mass of not less than 27,000 kilogrammes which conform to a type first issued with a type certificate on or after 1 April 1971, or 1 January 1970 in the case of an aeroplane having a maximum total authorised mass of not less than 230,000 kilogrammes, in respect of which an application has been made, and not withdrawn or refused for such a certificate of airworthiness and fly under the 'A Conditions' in respect of which there is in force a certificate of airworthiness in the Special Category</p>	<p>when flying on any flight</p>
<p>(9) Aeroplanes powered by one or more turbine jets or one or more turbine propeller engines and which have a maximum total authorised mass of not less than 15,000 kilogrammes or which, in accordance with the certificate of airworthiness in force in respect thereof, may carry more than 30 passengers –</p>	
<p>(a) except any such aeroplanes as come within subparagraph (b)</p>	<p>when flying for the purpose of public transport before 1 January 2005</p>
<p>(b) for which an individual certificate of airworthiness was first issued, whether in Mauritius or elsewhere, on or after 1 January 2001</p>	<p>when flying for the purpose of public transport</p>
<p>(c) for which an individual certificate of airworthiness was first issued, whether in Mauritius or elsewhere, before 1 January 2001</p>	<p>when flying for the purpose of public transport on or after 1 January 2005</p>
<p>(10) Aeroplanes which are powered by one or</p>	

more turbine jets or one or more turbine propeller engines and which have a maximum total authorised mass of not less than 5,700 kilogrammes nor more than 15,000 kilogrammes or which, in accordance with the certificate of airworthiness in force in respect thereof, may carry more than 9 passengers but not exceeding 30 passengers –	
(a) except any such aeroplanes as come within subparagraph (b)	when flying for the purpose of public transport on or after 1 October 2004
(b) which have equipment capable of giving warning to the pilot of the potentially hazardous proximity of ground or water installed before 1 April 2000	when flying for the purpose of public transport on or after 1 January 2005
(11) Aeroplanes which are powered by one or more turbine jets or one or more turbine propeller engines and which have a maximum total authorised mass of not less than 5,700 kilogrammes or which, in accordance with the certificate of airworthiness in force in respect thereof, may carry more than 9 passengers –	
(a) in respect of which there is in force a certificate of airworthiness except any such aeroplanes as come within subparagraph (b)	when flying for purposes other than public transport on or after 1 October 2004
(b) in respect of which there is in force a certificate of airworthiness and which have equipment capable of giving warning to the pilot of the potentially hazardous proximity of ground or water installed before 1 April 2000	when flying for purposes other than public transport on or after 1 January 2005
(12) Aeroplanes –	
(a) powered by one or more turbo-jets and which have a maximum total authorised mass of not less than 22,700 kilogrammes;	when flying by night for the purpose of the public transport of passengers
(b) having a maximum total authorised mass of not less than 5,700 kilogrammes and which conform to a type for which a certificate of airworthiness was first applied for, whether in Mauritius or elsewhere, after 30 April 1972, but not including any aeroplane which, in the opinion of the Authority, is identical in all matters affecting the provision of	when flying by night for the purpose of the public transport of passengers

emergency evacuation facilities to an aeroplane for which a certificate of airworthiness was first applied for before that date	
(c) which in accordance with the certificate of airworthiness in force in respect thereof, may carry more than 19 passengers	when flying by night for the purpose of public transport of passengers
(d) having a maximum total authorised mass exceeding 5,700 kilogrammes and which conform to a type for which a certificate of airworthiness was first applied for, whether in Mauritius or elsewhere, after 30 April 1972, but not including any aeroplane which, in the opinion of the Authority, is identical in all matters affecting the provision of emergency evacuation facilities to an aeroplane for which a certificate of airworthiness was first applied for before that date	when flying for the purpose of public transport of passengers
(e) powered by one or more turbo-jets and which have a maximum total authorised mass of not less than 22,700 kilogrammes; or	when flying for the purpose of the public transport of passengers
(f) first issued with a type certificate, whether in Mauritius or elsewhere, on or after 1 January 1958 and which, in accordance with the certificate of airworthiness in force in respect thereof, may carry more than 19 passengers	
(13) Aeroplanes –	
(a) powered by one or more turbine jets	when flying on any flight
(b) powered by one or more turbine propeller engines and having a maximum total authorised mass of not less than 5,700 kilogrammes and first issued with a certificate of airworthiness Mauritius on or after 1 April 1989	when flying on any flight
(14) Aeroplanes in respect of which there is in force a certificate of airworthiness in the Transport Category (Passenger)	when flying for the purpose of public transport of passengers
(15) Helicopters and Gyroplanes	(1) flying for purposes other than public transport, and when –

	(a) flying by day under Visual Flight Rules with visual ground reference
	(b) flying by day under Instrument Flight Rules or without visual ground reference –
	(i) outside controlled airspace
	(ii) within controlled airspace
	(c) when flying at night –
	(i) with visual ground reference
	(ii) without visual ground reference –
	(A) outside controlled airspace
	(B) within controlled airspace
	(2) flying for the purpose of public transport, and when –
	(a) flying by day under Visual Flight Rules with visual ground reference
	(b) flying by day under Instrument Flight Rules or without visual ground reference
	(c) flying by night with visual ground reference –
	(i) when flying with one pilot
	(ii) when flying in circumstances where 2 pilots are required
	(d) flying by night without visual ground reference
	(e) flying over water –
	(i) in the case of a helicopter or gyroplane

	classified in its certificate of airworthiness as being of performance group A2 or B when beyond auto-rotational gliding distance from land suitable for an emergency landing
	(ii) on all flights on which, in the event of any emergency occurring during the take-off or landing at the intended destination, or any likely alternate destination it is reasonably possible that the helicopter or gyroplane would be forced to land onto water
	(iii) in the case of a helicopter or gyroplane classified in its certificate of airworthiness as being of performance group A2 when beyond 10 minutes' flying time one from land
	(iv) for more than a total of 3 minutes in any flight
	(v) in the case of a helicopter or a gyroplane classified in its certificate of airworthiness as being of performance group A2 which is intended to fly beyond 10 minutes' flying time from land or which actually flies beyond 10 minutes' flying time from land, on a flight which is in support of or in connection with the offshore exploitation, or exploration of mineral resources, including gas, or is on a flight under and in accordance with the terms of a police air operator's certificate, when in either case the weather reports or forecasts available to the commander of the aircraft indicate that the sea temperature will be less than plus 10 °C during the flight or when any part of the flight is at night
	(f) on all flights which involve manoeuvres on water
	(g) when flying at a height of 10,000 feet or more above mean sea level –
	(i) having a certificate of airworthiness first issued, whether in Mauritius or elsewhere, before 1 January 1989
	(ii) having a certificate of airworthiness first issued, whether in Mauritius or elsewhere, on or after 1 January 1989
	(h) on flights when the weather reports or forecasts available at the aerodrome at the time of departure indicate that conditions favouring ice

	formation are likely to be met
	(i) on all flights on which the aircraft carries a flight crew of more than one person
	(j) on all flights for the purpose of the public transport of passengers
	(k) when flying over substantially uninhabited land areas where, in the event of an emergency landing, tropical conditions are likely to be met
	(l) when flying over substantially uninhabited land or other areas where, in the event of an emergency landing, polar conditions are likely to be met
	when flying by night for the purpose of the public transport of passengers
(16) Helicopters and gyroplanes –	when flying by night for the purpose of the public transport of passengers
(1) having a maximum total authorised mass of not less than 5,700 kilogrammes and which conform to a type for which a certificate of airworthiness was first applied for, whether in Mauritius or elsewhere, after 30 April 1972, but not including any helicopter or gyroplane which, in the opinion of the Authority, is identical in all matters affecting the emergency evacuation facilities to a helicopter or gyroplane for which a certificate of airworthiness was first applied for before that date	
(2) which, in accordance with the certificate of in respect thereof may carry more than 19 passengers; or	when flying on any flight
(3) which have a certificate of airworthiness issued in the Transport Category (Passenger or Cargo) and helicopters and gyroplanes in respect of which application has been made and not withdrawn or refused for such a certificate of airworthiness and which fly under the 'A Conditions' or have a certificate of airworthiness in the Special Category and	

<p>(i) which have a maximum total authorised mass of not less than 2,730 kilogrammes nor more than 7,000 kilogrammes or which in accordance with the certificate of airworthiness in force in respect thereof may carry more than 9 passengers, or both</p>	<p>when flying on any flight</p>
<p>(ii) which have a maximum total authorised mass of not less than 7,000 kilogrammes</p>	

5. The scales of equipment referred to in the Table set out in paragraph 4 shall be as follows –

(1) Scale A

(a) Spare fuses for all electrical circuits the fuses of which may be replaced in flight, consisting of 10 per cent of the number of every rating or 3 of each rating, whichever is the greater

(b) Maps, charts, codes and other documents and navigational equipment necessary, in addition to any other equipment required under these regulations, for the intended flight of the aircraft, including any diversion which may reasonably be expected

(c) First aid equipment of good quality, sufficient in quantity, having regard to the number of persons on board the aircraft, and, including –

- (i) roller bandages, triangular bandages, adhesive plaster, absorbent gauze, cotton wool (or wound dressings in place of the absorbent gauze and cotton wool), burn dressings, safety pins;
- (ii) haemostatic bandages or tourniquets, scissors;
- (iii) antiseptic, analgesic and stimulant drugs;
- (iv) splints, in the case of aeroplanes the maximum total mass authorised of which exceeds 5,700 kilogrammes;
- (v) a handbook on first aid

(d) In the case of a flying machine used for the public transport of passengers in which, while the flying machine is at rest on the ground, the sill of any external door intended for disembarkation of passengers, whether normally or in an emergency –

- (i) is more than 1.82 metres from the ground when the undercarriage of the machine is in the normal position for taxiing; or
- (ii) would be more than 1.82 metres from the ground if the undercarriage or any part thereof should collapse, break or fail to function, apparatus readily available for use at every such door consisting of a device or devices which will enable passengers to reach the ground safely in an emergency while the flying machine is on the ground, and can be readily fixed in position for use

(2) Scale AA

(a) Subject to sub subparagraph (b), an altitude alerting system capable of alerting the pilot approaching a preselected altitude in ascent or descent, by a sequence of visual and aural signals in sufficient time to establish level flight at that preselected altitude and when deviating above or below that preselected altitude, by a visual and an aural signal

(b) If the system becomes unserviceable, the aircraft may fly or continue to fly, until it first lands at a place at which it is reasonably practicable for the system to be repaired or replaced

(3) Scale B

(a) (i) Where the maximum total mass authorised of the aircraft is 2,730 kilogrammes or less, for every pilot's seat and any seat situated alongside a pilot's seat, a safety belt with one diagonal shoulder strap or safety harness, or with the permission of the Authority, a safety belt without a diagonal shoulder strap which permission may be granted if the Authority is satisfied that it is not reasonably practicable to fit a safety belt with one diagonal shoulder strap or a safety harness

(ii) Where the maximum total mass authorised of the aircraft exceeds 2,730 kilogrammes, a safety harness for every pilot's seat and any seat situated alongside a pilot's seat, or with the permission of the Authority, a safety belt with one diagonal shoulder strap which permission may be granted if the Authority is satisfied that it is not reasonably practicable to fit a safety harness

(iii) For every seat in use, not being a seat referred to in sub sub subparagraphs (i), (ii), (v) and (vi), a safety belt with or without one diagonal shoulder strap or a safety harness

(iv) In addition and to be attached to or secured by the equipment required in sub sub subparagraph (iii), a child restraint device for every child under the age of 2 years on board

(v) On all flights for the public transport of passengers by aircraft, for every seat for use by cabin crew who are required to be carried under this regulation, a safety harness

(vi) On all flights in aeroplanes in respect of which a certificate of airworthiness was first issued, in Mauritius or elsewhere, on or after 1 February 1989, the maximum total mass authorised of which does not exceed 5,700 kilogrammes which, in accordance with the certificate of airworthiness in force thereof, is not capable of seating more than 9 passengers (otherwise than in seats referred to in sub sub subparagraphs (i) and (ii)), a safety belt with one diagonal shoulder strap or a safety harness for every seat intended for use by a passenger

(b) If the commander cannot, from his own seat, see all the passenger's seats in the aircraft, a means of indicating to the passengers that seat belts should be fastened

(c) (i) Subject to sub sub subparagraph (ii), a safety harness for every seat in use

(ii) In the case of an aircraft carrying out aerobatic manoeuvres consisting only of erect spinning, the Authority may permit a safety belt with one diagonal shoulder strap to be fitted if it is satisfied that such restraint is sufficient for the carrying out of erect spinning in that aircraft and it is not reasonably practicable to fit a safety harness in that aircraft

(4) Scale C

(a) Equipment for displaying the lights required by these regulations

(b) Electrical equipment, supplied from the main source of supply in the aircraft, to provide sufficient illumination to enable the flight crew to carry out their duties properly during flight

(c) Unless the aircraft is equipped with radio, devices for making the visual signal specified in the Fourteenth Schedule as indicating a request for permission to land

(5) Scale D

(a) (i) In the case of a helicopter or gyroplane, a slip indicator

(ii) In the case of any other flying machine –

(A) a turn indicator and a slip indicator; or

(B) a gyroscopic bank and pitch indicator and a gyroscopic direction indicator

(b) A sensitive pressure altimeter adjustable for any sea level barometric pressure which the weather report or forecasts available to the commander of the aircraft indicate is likely to be encountered during the intended flight

(6) Scale E

(a) (i) In the case of a helicopter or gyroplane, a slip indicator

(ii) in the case of any other flying machine, a slip indicator and a turn indicator or, at the

option of the operator, an additional gyroscopic bank and pitch indicator

(b) A gyroscopic bank and pitch indicator

(c) A gyroscopic direction indicator

(d) A sensitive pressure altimeter adjustable for any sea level barometric pressure which the weather report or forecasts available to the commander of the aircraft indicate is likely to be encountered during the intended flight

(7) Scale EE

(a) Subject to sub subparagraph (b), a radio altimeter with an audio voice warning operating below a preset height and a visual warning capable of operating at a height selectable by the pilot

(b) A helicopter flying under, and in accordance with the terms of a police air operator's certificate, may instead be equipped with a radio altimeter with an audio warning and a visual warning each capable of operating at a height selectable by the pilot

(8) Scale F

(a) A timepiece indicating the time in hours, minutes and seconds

(b) A means of indicating whether the power supply to the gyroscopic instrument is adequate

(c) A rate of climb and descent indicator

(d) Where the maximum total mass authorised of the aircraft exceeds 5,700 kilogrammes a means of indicating outside air temperature

(e) Where the maximum total mass authorised of the aircraft exceeds 5,700 kilogrammes 2 air speed indicators

(9) Scale G

(a) In the case of an aircraft other than a helicopter or gyroplane, landing lights consisting of 2 single filament lamps, or one dual filament lamp with separately energised filaments

(b) An electrical lighting system to provide illumination in every passenger compartment

(c) (i) One electric torch for every member of the crew; or

(ii) (A)

one electric torch for every member of the flight crew of the aircraft; and

(B)

at least one electric torch affixed adjacent to every floor level exit intended for the disembarkation of passengers whether normally or in an emergency, which shall –

(I) be readily accessible for use by the crew; and

(II) number in total not less than the minimum number of members of the cabin crew required to be carried with a full passenger complement

(d) In the case of an aircraft other than a helicopter or gyroplane of which the maximum total mass authorised exceeds 5,700 kilogrammes, means of observing the existence and build up of ice on the aircraft

(e) (i) In the case of a helicopter or gyroplane in respect of which there is in force a certificate of airworthiness designating the helicopter or gyroplane as being of performance group A –

(A) 2 landing lights both of which are adjustable to illuminate the ground in front of and below the helicopter or gyroplane and one of which is adjustable to illuminate the ground on every side of the helicopter or gyroplane; or

(B) one landing light or, if the maximum total mass authorised of the helicopter or gyroplane exceeds 5,700 kilogrammes, one dual filament landing light with separately energised filaments, or 2 single filament lights, each of which is adjustable to illuminate the ground in front of and below the helicopter or gyroplane, and 2 parachute flares

(ii) In the case of a helicopter or gyroplane in respect of which there is in force a certificate of airworthiness designating the helicopter or gyroplane as being of performance group B –

- (A) one landing light and 2 parachute flares; or
- (B) if the maximum total mass authorised of the helicopter or gyroplane exceeds 5,700 kilogrammes, one dual filament landing light with separately energised filaments or 2 single filament landing lights, and 2 parachute flares

(10) Scale H

- (a) Subject to sub subparagraph (b), for every person on board, a life-jacket shall be equipped with a whistle and waterproof torch
- (b) Life-jackets constructed and carried solely for use by children under 3 years of age may not be equipped with a whistle

(11) Scale I

A survival suit for every member of the crew

(12) Scale J

- (a) Additional flotation equipment, capable of supporting one-fifth of the number of persons on board, and provided in a place of stowage accessible from outside the flying machine
- (b) Parachute distress rocket signals capable of making, from the surface of the water, the pyrotechnical signal of distress specified in the Fourteenth Schedule
- (c) A sea anchor and other equipment necessary to facilitate mooring, anchoring or manoeuvring the flying machine on water, appropriate to its size, mass and handling characteristics

(13) Scale K

- (a) (i) In the case of a flying machine, other than a helicopter or gyroplane carrying 20 or more persons, life rafts sufficient to accommodate all persons on board
- (ii) In the case of a helicopter or gyroplane carrying 20 or more persons, a minimum of 2 life rafts sufficient together to accommodate all persons on board
- (b) Every life raft shall contain the following equipment –
 - (i) means for maintaining buoyancy;
 - (ii) a sea anchor;
 - (iii) lifelines, and means of attaching one life raft to another;
 - (iv) paddles or other means of propulsion;
 - (v) means of protecting the occupants from the elements;
 - (vi) a waterproof torch;
 - (vii) marine type pyrotechnical distress signals;
 - (viii) means of making sea water drinkable, unless the full quantity of fresh water is carried as specified in sub subparagraph (ix);
 - (ix) for every 4 or proportion of 4 persons, the life raft is designed to carry –
 - (A) 100 grammes of glucose toffee tablets; and
 - (B) half a litre of fresh water in durable containers, or in any case in which it is not reasonably practicable to carry the quantity of water specified above, as large a quantity of fresh water as is reasonably practicable in the circumstances. In no case shall the quantity of water carried be less than is sufficient, when added to the amount of fresh water capable of being produced by means of the equipment specified in sub subparagraph (viii) to provide half a litre of water for every 4 or proportion of 4 persons the life raft is designed to carry;
 - (x) first aid equipment
- (c) Sub subparagraphs (b)(vi) to (x), inclusive, shall be contained in a pack
- (d) The number of survival beacon radio apparatus carried when the aircraft is carrying the number of life rafts specified in the first column of the following Table shall be not less than the number

specified in, or calculated in accordance with the second column –

Life raft	Apparatus
Not more than 8 life rafts	2 survival beacon radio apparatus
For every additional 4 or proportion of 4 life rafts	one additional survival beacon apparatus

(e) In the case of a helicopter or gyroplane, an emergency beacon which is automatically deployed and activated in the event of a crash

(14) Scale L1

PART I

(a) In every flying machine which is provided with means for maintaining a pressure greater than 700 hectopascals throughout the flight in the flight crew compartment and in the compartments in which the passengers are carried –

- (i) a supply of oxygen sufficient, in the event of failure to maintain such pressure, occurring in the circumstances specified in the first and second columns of the table set out in Part II, for continuous use, during the periods specified in the third column of the table, by the persons for whom oxygen is to be provided in accordance with the fourth column of the table; and
- (ii) in addition, in every case where the flying machine flies above flight level 350, a supply of oxygen in a portable container sufficient for the simultaneous first aid treatment of 2 passengers, together with suitable and sufficient apparatus to enable such persons to use the oxygen

(b) In any other flying machine a supply of oxygen sufficient for continuous use by –

- (i) all the crew other than the flight crew, and if passengers are carried, by 10 per cent of the number of passengers, for any period exceeding 30 minutes during which the flying machine flies above flight level 100, but not above flight level 130 and the flight crew shall be supplied with oxygen sufficient for continuous use for any period during which the flying machine flies above flight level 100; and
- (ii) all persons on board for the whole time during which the flying machine flies above flight level 130; together with suitable and sufficient apparatus to enable such persons to use the oxygen

(c) The quantity of oxygen required for the purpose of complying with paragraphs (a) and (b) of this Part shall be computed in accordance with the information and instructions relating thereto specified in the operations manual relating to the aircraft pursuant to item (vi) of Part I of the Twelfth Schedule

PART II

Vertical displacement of the flying machine in relation to flight levels	Capability of flying machine to descend (where relevant)	Period of supply of oxygen	Per
Above flight level 100		30 minutes or the period specified at A hereunder, whichever is the greater	In a whor spec

Above flight level of not less than 100 nor more than 300	Flying machine is either flying at or below flight level 150 or is capable of descending and continuing to destination as specified at X hereunder	30 minutes of the period specified at A hereunder, whichever is the greater	10 p
	Flying machine is flying above flight level 150 and is not so capable	10 minutes or the period specified at B hereunder, whichever is the greater	All p
		and in addition	
		30 minutes or the period specified at C hereunder, whichever is the greater	10 p
Above flight level of not less than 300 nor more than 350	Flying machine is capable of descending and continuing to destination as specified at Y hereunder	30 minutes or the period specified at A hereunder, whichever is the greater	15 p
	Flying machine is not so capable	10 minutes or the period specified at B hereunder, whichever is the greater	All p
		and in addition	
		30 minutes or the period specified at C hereunder, whichever is the greater	15 pass
Above flight level 350 ...		10 minutes or the period specified at B hereunder, whichever is the greater	All p
		and in addition	
		30 minutes or the period specified at C hereunder, whichever is the greater	15 p pass

- A** The whole period during which, after a failure to maintain a pressure greater than 700 hectopascal in the control compartment and in the compartments in which passengers are carried has occurred, the flying machine flies above flight level 100.
- B** The whole period during which, after a failure to maintain such pressure has occurred, the flying machine flies above flight level 150.
- C** The whole period during which, after a failure to maintain such pressure has occurred, the flying machine flies above flight level 100, but not above flight level 150.
- X** The flying machine is capable, at the time when a failure to maintain such pressure occurs,

of descending in accordance with the emergency descent procedure specified in the relevant flight manual and without flying below the minimum altitudes for safe flight specified in the operations manual relating to the aircraft, to flight level 150 within 6 minutes, and of continuing at or below that flight level to its place of intended destination or any other place at which a safe landing may be made.

Y The flying machine is capable, at the time when a failure to maintain such pressure occurs, of descending in accordance with the emergency descent procedure specified in the relevant flight manual and without flying below the minimum altitudes for safe flight specified in the operations manual relating to the aircraft, to flight level 150 within 4 minutes, and of continuing at or below that flight level to its place of intended destination or any other place at which a safe landing may be made.

(15) Scale L2

A supply of oxygen and the associated equipment to meet the requirements set out in Parts I and II. The duration for the purposes of this Scale shall be –

- (a) that calculated in accordance with the operations manual prior to the commencement of the flight, being the period or periods which it is reasonably anticipated that the aircraft will be flown in the circumstances of the intended flight at a height where the said requirements apply and in calculating the said duration account shall be taken of –
 - (i) in the case of pressurised aircraft, the possibility of depressurisation when flying above flight level 100;
 - (ii) the possibility of failure of one or more of the aircraft engines;
 - (iii) restrictions due to required minimum safe altitude;
 - (iv) fuel requirement; and
 - (v) the performance of the aircraft; or
- (b) the period or periods during which the aircraft is actually flown in the circumstances specified in the said Parts,

whichever is the greater.

PART I – UNPRESSURISED AIRCRAFT

1. When flying at or below flight level 100 – Nil
2. When flying above flight level 100 but not exceeding flight level 120 –

Item no.	Supply for	Duration
(1)	Members of the flight crew	Any period during which the aircraft flies above flight level 100
(2)	Members of the cabin crew and 10 per cent of passengers	For any continuous period exceeding 30 minutes during which the aircraft flies above flight level 100, but not exceeding flight level 120, the duration shall be the period by which 30 minutes is exceeded

3. When flying above flight level 120 –

Supply for	Duration
(1) Members of the flight crew	Any period during which the aircraft flies above

	flight level 120
(2) Members of the cabin crew and 10 per cent of passengers	Any period during which the aircraft flies above flight level 120

PART II – PRESSURISED AIRCRAFT

1. When flying at or below flight level 100 – Nil
2. When flying above flight level 100 but not exceeding flight level 250 –

Item no.	Supply for	Duration
(1)	Members of the flight crew	30 minutes or whenever the cabin pressure altitude exceeds 10,000 ft, whichever is the greater
(2)	Members of the cabin crew and 10 per cent of passengers	(1) Where the aircraft is capable of descending and continuing its destination as specified at A hereunder, 30 minutes or whenever the cabin pressure altitude exceeds 10,000 ft, whichever is the greater
		(2) Where the aircraft is not so capable, whenever the cabin pressure altitude is not less than 10,000 ft, nor more than 12,000 ft
(3)	Members of the cabin crew and passengers	(1) Where the aircraft is capable of descending and continuing its destination as specified at A hereunder, no requirement other than that at paragraph (2) of item no. 2 of this part of this Scale
		(2) Where the aircraft is not so capable and the cabin pressure altitude exceeds 12,000 ft, duration shall be the period when the pressure altitude exceeds 12,000 ft or 10 minutes, whichever is the greater

3. When flying above flight level 250 –

Item no.	Supply for	Duration
(1)	Members of the flight crew	2 hours or whenever the cabin pressure

	altitude exceeds 10,000 ft, whichever is the greater
(2) Members of the cabin crew	Where the cabin pressure altitude exceeds 10,000 ft, and a portable supply for 15 minutes
(3) 10 per cent of passengers	Where the cabin pressure altitude is not less than 10,000 ft nor more than 12,000 ft
(4) 30 per cent of passengers	Where the cabin pressure altitude is not less than 12,000 ft nor more than 15,000 ft
(5) All passengers	Where the cabin pressure altitude exceeds 15,000 ft, the duration shall be the period when the cabin pressure altitude exceeds 15,000 feet or 10 minutes, whichever is the greater
2 per cent of passengers or 2 passengers, whichever is the greater, being a supply of first aid oxygen which must be available for simultaneous first aid treatment of 2 per cent or 2 passengers wherever they are seated in the aircraft	Where, after decompression, the cabin pressure altitude exceeds 8,000 feet

A The flying machine is capable, at the time when a failure to maintain cabin pressurisation occurs, of descending in accordance with the emergency descent procedure specified in the relevant flight manual and without flying below the minimum altitudes for safe flight specified in the operations manual relating to the aircraft, to flight level 120 within 5 minutes and of continuing at or below that flight level to its place of intended destination or any other place at which a safe landing may be made.

(16) Scale M

Equipment to prevent the impairment through ice formation of the functioning of the controls, means of propulsion, lifting surfaces, windows or equipment of the aircraft so as to endanger the safety of the aircraft

(17) Scale N

An intercommunication system for use by all members of the flight crew and, including microphones, not of a hand held type, for use by the pilot and flight engineer, if any

(18) Scale O

(a) Subject to sub subparagraph (b), radar set capable of giving warning to the pilot in command of the aircraft and to the co-pilot of the presence of cumulonimbus clouds and other potentially hazardous weather conditions

(b) A flight may commence if the set is unserviceable or continue if the set becomes unserviceable thereafter –

- (i) so as to give the warning only to one pilot, so long as the aircraft is flying only to the place at which it first becomes reasonably practicable for the set to be repaired; or
- (ii) when the weather report or forecasts available to the commander of the aircraft indicate that cumulonimbus clouds or other potentially hazardous weather conditions, which can be detected by the set when in working order, are unlikely to be encountered on the intended route or any planned diversion therefrom or the commander has satisfied

himself that any such weather conditions will be encountered in daylight and can be seen and avoided, and the aircraft is, in either case, operated throughout the flight in accordance with any relevant instruction given in the operations manual

(19) Scale P

(a) Subject to sub subparagraphs (b) and (c), a flight data recorder which is capable of recording, by reference to a time-scale, the following data –

- (i) indicated airspeed;
- (ii) indicated altitude;
- (iii) vertical acceleration;
- (iv) magnetic heading;
- (v) pitch attitude, if the equipment provided in the aeroplane is of such a nature as to enable this item to be recorded;
- (vi) engine power, if the equipment provided in the aeroplane is of such a nature as to enable this item to be recorded;
- (vii) flap position;
- (viii) roll attitude, if the equipment provided in the aeroplane is of such a nature as to enable this item to be recorded

(b) Subject to sub subparagraph (e), any aeroplane having a maximum total mass authorised not exceeding 11,400 kilogrammes may be provided with –

- (i) a flight data recorder capable of recording the data specified in sub subparagraph(a)(i) to (viii); or
- (ii) a 4-channel cockpit voice recorder.

(c) Subject to sub subparagraph (c), in addition, on all flights by turbine-powered aeroplanes having a maximum total authorised mass of not less than 11,400 kilogrammes, a 4-channel cockpit voice recorder

(d) The flight data recorder and cockpit voice recorder referred to in sub subparagraph (c) shall be so constructed that the record will be likely to be preserved in the event of an accident to the aeroplane

(e) An aeroplane shall not be required to carry the equipment referred to in sub subparagraph (c), if before take-off, the equipment is found to be unserviceable and the aircraft flies in accordance with arrangements approved by the Authority

(20) Scale Q

If the maximum total mass authorised of the aeroplane exceeds 5,700 kilogrammes and it was first registered, whether in the Republic of Mauritius or elsewhere, on or after 1 June 1965, a door between the flight crew compartment and any adjacent compartment to which passengers have access, which door shall be fitted with a lock or bolt capable of being worked from the flight crew compartment

(21) Scale R

(a) (i) In respect of aeroplanes having a maximum total authorised mass of not less than 5,700 kilogrammes, equipment sufficient to protect the eyes, nose and mouth of all members of the flight crew required to be carried by virtue of regulation 30 for a period of not less than 15 minutes and, in addition, where the minimum flight crew required is more than one and a member of the cabin crew is not required to be carried by virtue of regulation 31, portable equipment sufficient to protect the eyes, nose and mouth of one member of the flight crew for a period of not more than 15 minutes

(ii) In respect of aeroplanes having a maximum total authorised mass not exceeding 5,700 kilogrammes, the equipment specified in paragraph (a)(i) or, in the case of such aeroplanes restricted by virtue of the operations manual to fly at or below flight level 250 and capable of descending as specified at A hereunder, such equipment sufficient to protect the eyes only

(b) (i) In respect of aeroplanes having a maximum total authorised mass of not less than

5,700 kilogrammes, portable equipment to protect the eyes, nose and mouth of all members of the cabin crew required to be carried by virtue of regulation 31 for a period of not less than 15 minutes.

(ii) In respect of aeroplanes having a maximum total mass authorised not exceeding 5,700 kilogrammes, subject to sub sub subparagraph (iii), the equipment specified in sub subparagraph (b)(i).

(iii) Sub sub subparagraph (ii) shall not apply to such aeroplanes restricted by virtue of the operations manual to fly at or below flight level 250 and capable of descending as specified at A hereunder.

The aeroplane is capable of descending in accordance with the emergency descent procedure specified in the relevant flight manual and without flying below the minimum altitudes for safe flight specified in the operations manual relating to the aeroplane, to flight level 100 within 4 minutes and of continuing at or below that flight level to its place of intended destination or any other place at which a safe landing may be made.

(22) Scale S

(a) A 4-channel cockpit voice recorder or flight data recorder capable of recording, by reference to a time scale, the data required to determine the following matters accurately in respect of the aeroplane – the flight path, attitude and the basic lift, thrust and drag forces acting upon it.

(b) A 4-channel cockpit voice recorder and flight data recorder capable of recording, by reference to a time scale, the data required to determine the following matters accurately in respect of the aeroplane – the information specified in sub subparagraph (a) together with use of VHF transmitters.

(c) A 4-channel cockpit voice recorder and flight data recorder capable of recording, by reference to a time scale, the data required to determine the following matters accurately in respect of the aeroplane – the flight path, attitude, the basic lift, thrust and drag forces acting upon it, the selection of high lift devices, if any, and air-brakes, if any, the position of primary flying control and pitch trim surfaces, outside air temperature, instrument landing deviations, use of automatic flight control systems, VHF transmitters, radio altitude, if any, the level or availability of essential AC electricity supply and cockpit warnings relating to engine fire and engine shut down, cabin pressurisation, presence of smoke and hydraulic/pneumatic power supply.

(d) A cockpit voice recorder and flight data recorder or combined cockpit voice recorder/flight data recorder capable in either case of recording by reference to a time scale the data required to determine the following matters accurately in respect of the aeroplane –

- (i) the flight path;
- (ii) speed;
- (iii) attitude;
- (iv) engine power;
- (v) outside air temperature;
- (vi) configuration of lift and drag devices;
- (vii) use of VHF transmitters; and
- (viii) use of automatic flight control systems

(e) A cockpit voice recorder and flight data recorder capable of recording, by reference to a time scale, the data required to determine the following matters accurately in respect of the aeroplane –

- (i) the flight path;
- (ii) speed;
- (iii) attitude;
- (iv) engine power;
- (v) outside air temperature;
- (vi) configuration of lift and drag devices;
- (vii) use of VHF transmitters; and

(viii) use of automatic flight control systems

(f) A cockpit voice recorder and flight data recorder capable of recording, by reference to a time scale, the data required to determine the following matters accurately in respect of the aeroplane –

- (i) the flight path;
- (ii) speed;
- (iii) attitude;
- (iv) engine power;
- (v) outside air temperature;
- (vi) instrument landing system deviations;
- (vii) marker beacon passage;
- (viii) radio altitude;
- (ix) configuration of the landing gear and lift and drag devices;
- (x) position of primary flying controls;
- (xi) pitch trim position;
- (xii) use of automatic flight control systems;
- (xiii) use of VHF transmitters;
- (xiv) ground speed/drift angle or latitude/longitude if the navigational equipment provided in the aeroplane is of such a nature as to enable this information to be recorded with reasonable practicability;
- (xv) cockpit warnings relating to ground proximity; and
- (xvi) the master warning system

Note 1 – An aircraft shall not be required to carry the said equipment, if before take-off, the equipment is found to be unserviceable and the aircraft flies in accordance with arrangements approved by the Authority.

Note 2 – The cockpit voice recorder, flight data recorder or combined cockpit voice recorder/flight data recorder, as the case may be, shall be so constructed that the record will be likely to be preserved in the event of an accident.

(23) Scale SS

(a) Subject to sub subparagraph (iv), a 4-channel cockpit voice recorder capable of recording and retaining the data recorded during at least the last 30 minutes of its operation and a flight data recorder capable of recording and retaining the data recorded during at least the last 8 hours of its operation, being the data required to determine, by reference to a time scale, the following matters accurately in respect of the helicopter or gyroplane –

- (i) flight path;
- (ii) speed;
- (iii) attitude;
- (iv) engine power;
- (v) main rotor speed;
- (vi) outside air temperature;
- (vii) position of pilot's primary flight controls;
- (viii) use of VHF transmitters;
- (ix) use of automatic flight controls;
- (x) use of stability augmentation system;
- (xi) cockpit warnings relating to the master warning system; and

(xii)

selection of hydraulic system and cockpit warnings of failure of essential hydraulic systems.

(b) Subject to sub subparagraph (d), a 4-channel cockpit voice recorder capable of recording and retaining the data recorded during at least the last 30 minutes of its operation and a flight data recorder capable of recording and retaining the data recorded during at least the last 8 hours of its operation, being the data required to determine, by reference to a time scale, the information specified in sub subparagraph (i) together with the following matters accurately in respect of the helicopter or gyroplane –

(i) landing gear configuration;

(ii)

indicated sling load force if an indicator is provided in the helicopter or gyroplane of such a nature as to enable this information to be recorded with reasonable practicability;

(iii) radio altitude;

(iv) instrument landing system deviations;

(v) marker beacon passage;

(vi)

ground speed/drift angle or latitude/longitude if the navigational equipment provided in the helicopter or gyroplane is of such a nature as to enable this information to be recorded with reasonable practicability; and

(vii) main gear box oil temperature and pressure.

(c) Subject to sub subparagraph (iv) –

(i) A combined cockpit voice recorder and flight data recorder which meets the following requirements –

(A) in the case of a helicopter or gyroplane which is otherwise required to carry a flight data recorder specified at sub subparagraph (i), the flight data recorder shall be capable of recording the data specified therein and retaining it for the duration therein specified;

(B) in the case of a helicopter or gyroplane which is otherwise required to carry a flight data recorder specified at sub subparagraph (ii), the flight data recorder shall be capable of recording the data specified therein and retaining it for the duration therein specified;

(C) the cockpit voice recorder shall be capable of recording and retaining at least the last hour of cockpit voice recording information on not less than 3 separate channels.

(ii) (A) In any case when a combined cockpit voice recorder/flight data recorder specified at sub subparagraph (c)(i) is required to be carried by these regulations, the flight data recorder shall be capable, subject to sub subparagraph (B), of retaining as protected data the data recorded during at least the last 5 hours of its operation or the maximum duration of the flight, whichever is the greater. It shall also be capable of retaining additional data as unprotected data for a period which, together with the period for which protected data is required to be retained, amounts to a total of 8 hours.

(B) The flight data recorder need not be capable of retaining the said additional data if additional data is retained which relates to the period immediately preceding the period to which the required protected data relates or for such other period as the Authority may permit pursuant to regulation 59 and the additional data is retained in accordance with arrangements approved by the Authority.

(d) A helicopter or gyroplane shall not be required to carry the said equipment if, before take-off, the equipment is found to be unserviceable and the aircraft flies in accordance with arrangements approved by the Authority. With the exception of flight data which it is expressly stated above may be unprotected, the cockpit voice recorder, flight data recorder or combined cockpit voice recorder and flight data recorder, as the case may be, shall be so constructed and installed that the record (herein

referred to as 'protected data') would be likely to be preserved in the event of an accident and every cockpit voice recorder, flight data recorder or combined cockpit voice recorder/flight data recorder required to be carried on the helicopter or gyroplane shall have attached an automatically activated underwater sonar location device or an emergency locator radio transmitter.

(24) Scale T

Two emergency located transmitters, one being fixed and one portable

(25) Scale U

- (a) One survival beacon radio apparatus
- (b) Marine type pyrotechnical distress signals
- (c) For every 4 or proportion of 4 persons on board, 100 grammes of glucose toffee tablets
- (d) For every 4 or proportion of 4 persons on board, half litre of fresh water in durable containers
- (e) First aid equipment

(26) Scale V

- (a) One survival beacon radio apparatus
- (b) Marine type pyrotechnical distress signals
- (c) For every 4 or proportion of 4 persons on board, 100 grammes of glucose toffee tablets
- (d) For every 4 or proportion of 4 persons on board, half litre of fresh water in durable containers
- (e) First aid equipment
- (f) For every 75 or proportion of 75 persons on board, one stove suitable for use with aircraft fuel
- (g) One cooking utensil, in which snow or ice can be melted
- (h) Two snow shovels
- (i) Two ice saws
- (j) Single or multiple sleeping-bags, sufficient for the use of one-third of all persons on board
- (k) One arctic suit for every member of the crew of the aircraft

(27) Scale W

(a) Subject to sub subparagraph (b), cosmic radiation detection equipment calibrated in milliSievert per hour and capable of indicating the action and alert levels of radiation dose rate

(b) No aircraft shall be required to carry the said equipment if, before take-off, the equipment is found to be unserviceable and it is not reasonably practicable to repair or replace it at the aerodrome of departure and the radiation forecast available to the commander of the aircraft indicates that hazardous radiation conditions are unlikely to be encountered by the aircraft on its intended route or any planned diversion therefrom.

(28) Scale X

(a) Subject to sub subparagraph (a), a Ground Proximity Warning System being equipment capable of giving warning to the pilot of the potentially hazardous proximity of ground or water

(b) Subject to sub subparagraph (c), a Terrain Awareness and Warning System being equipment capable of giving warning to the pilot of the potentially hazardous proximity of ground or water, including a predictive terrain hazard warning function

(c) Where the equipment becomes unserviceable, the aircraft may fly or continue to fly until it first lands at a place at which it is reasonably practicable for the equipment to be repaired or replaced.

(29) Scale Y

(a) If the aircraft may, in accordance with its certificate of airworthiness, carry more than 19 and less than 100 passengers, one portable battery powered megaphone capable of conveying instructions to all persons in the passenger compartment and readily available for use by a member of the crew.

(b) If the aircraft may, in accordance with its certificate of airworthiness, carry more than 99 and

less than 200 passengers, 2 portable battery powered megaphones, together, capable of conveying instructions to all persons in the passenger compartment and each being readily available for use by a member of the crew.

(c) If the aircraft may, in accordance with its certificate of airworthiness, carry more than 199 passengers, 3 portable battery powered megaphones, together, capable of conveying instructions to all persons in the passenger compartment and each being readily available for use by a member of the crew.

(d) If the aircraft may, in accordance with its certificate of airworthiness, carry more than 19 passengers –

- (i) a public address system; and
- (ii) an interphone system of communication between members of the flight crew and the cabin crew.

(30) Scale Z

(a) An emergency lighting system to provide illumination in the passenger compartment sufficient to facilitate the evacuation of the aircraft notwithstanding the failure of the lighting systems specified in sub subparagraph (b) of Scale G

(b) An emergency lighting system to provide illumination outside the aircraft sufficient to facilitate the evacuation of the aircraft

(c) (i) Subject to sub subparagraph (ii), an emergency floor path lighting system in the passenger compartment sufficient to facilitate the evacuation of the aircraft notwithstanding the failure of the lighting systems specified in sub subparagraph (b) of Scale G

(ii) If the equipment specified in sub subparagraph (i) becomes unserviceable, the aircraft may fly or continue to fly in accordance with arrangements approved by the Authority.

NINTH SCHEDULE

[Regulations 20(1),(2), (3) and (9)]

1. An aircraft maintenance engineer may, subject to the terms and conditions of his licence, issue certificates referred to hereunder.

(1) Aircraft Maintenance Engineer – Category A

(a) An aircraft maintenance licence permits the holder of the licence to issue certificates of release to service following minor scheduled line maintenance and simple defect rectification, as specified in the Mauritius Civil Airworthiness Requirements (MCAR – Part 145), within the limits of tasks specifically endorsed on the authorisation.

(b) The certification privileges are restricted to work that the authorisation holder has personally performed.

(2) Aircraft Maintenance Engineer – Category B1

An aircraft maintenance licence permits the holder of the licence to issue certificates of release to service following maintenance of the aircraft structure, power plant, mechanical and electrical systems, and replacement of avionic line replaceable units requiring simple tests to prove their serviceability. Category B1 shall automatically include the appropriate A subcategory.

(3) Aircraft Maintenance Engineer – Category B2

An aircraft maintenance licence permits the holder of the licence to issue certificates of release to service following maintenance of avionic and electrical systems.

(4) Aircraft Maintenance Engineer – Category C

An aircraft maintenance licence permits the holder of the licence to issue certificates of release to service following base maintenance on aircraft. The privileges apply to the aircraft in its entirety in an MCAR – Part 145 approved maintenance organisation.

2. The holder of an aircraft maintenance licence may not exercise certification privileges unless –

(a) he complies with the applicable requirements of MCAR – Part 145; and

Aircraft and circumstances of flight	Scale of equipment required								
	A	B	C	D	E	F	G	H	J
visual reference to landmarks									
(ii) on all other occasions	A	B							
(d) when flying under Instrument Flight Rules within controlled airspace and not required to comply with subparagraph (4)(a) above	A*								
(5) As from 12 March 2004, all aeroplanes registered in Mauritius, wherever they may be, and all aeroplanes wherever registered when flying in Mauritius, powered by one or more turbine jets or turbine propeller engines and having a maximum take-off weight of not less than 15,000 kilogrammes or which, in accordance with the certificate of airworthiness in force in respect thereof, may carry more than 30 passengers									J

*Unless the appropriate air traffic control unit otherwise permits, in relation to the particular flight, and the aircraft complies with any instruction, which the air traffic control unit may give in the particular case.

#Non-public transport aircraft flying in Class D and E airspace shall not be required to be provided with distance measuring equipment.

4. The scales of radio and radio navigation equipment indicated in the Table shall be specified hereunder –

(1) Scale A

Radio equipment capable of maintaining direct 2-way communication with the appropriate aeronautical radio stations

(2) Scale B

Radio navigation equipment capable of enabling the aircraft to be navigated on the intended route, including such equipment as may be prescribed

(3) Scale C

Radio equipment capable of receiving from the appropriate aeronautical radio stations meteorological, broadcasts relevant to the intended flight

(4) Scale D

Radio navigation equipment capable of receiving signals from one or more aeronautical radio stations on the surface to enable the aircraft to be guided to a point from which a visual landing may be made at the aerodrome at which the aircraft is to land

(5) Scale E

Secondary surveillance radar equipment which includes a pressure altitude reporting transponder capable of operating in Modes A and C and being operated in accordance with such instructions as may be given to the aircraft by the air traffic control unit

(6) Scale F

Radio and radio navigation equipment capable of enabling the aircraft to be navigated along the intended route, including –

- (a) automatic direction finding equipment;
- (b) distance measuring equipment; and
- (c) VHF omni-range equipment

(7) Scale G

Radio navigation equipment capable of enabling the aircraft to make an approach to landing using the Instrument Landing System

(8) Scale H

(a) Subject to sub subparagraph (b), radio navigation equipment capable of enabling the aircraft to be navigated on the intended route, including –

- (i) automatic direction finding equipment;
- (ii) distance measuring equipment;
- (iii) duplicated VHF omni-range equipment; and
- (iv) a 75 MHz marker beacon receiver

(b) (i) An aircraft may fly notwithstanding that it does not carry the equipment specified in this Scale if it carries alternative radio navigation equipment or navigational equipment approved by the Authority in writing in accordance with regulation 23.

(ii) Where not more than one item of equipment specified in this Scale is unserviceable when the aircraft is about to begin a flight, the aircraft may nevertheless take-off on that flight if –

- (A) it is not reasonably practicable for the repair or replacement of that item to be carried out before the beginning of the flight;
- (B) the aircraft has not made more than one flight since the item was last serviceable; and
- (C) the commander of the aircraft has satisfied himself that, taking into account the latest information available as to the route and aerodrome to be used, including any planned diversion, and the weather conditions likely to be encountered, the flight may be made safely and in accordance with any relevant requirements of the appropriate air traffic control unit.

(9) Scale I

An airborne collision avoidance system

5. In this Schedule –

“airborne collision avoidance system” means an aeroplane system which –

- (a) conforms to requirements prescribed for the purpose;
- (b) is based on secondary surveillance radar transponder signals;
- (c) operates independently of ground based equipment; and
- (d) is designed to provide advice and appropriate avoidance manoeuvres to the pilot in relation to other aeroplanes which are equipped with secondary surveillance radar and are in undue

proximity;

“automatic direction finding equipment” means radio navigation equipment which automatically indicates the bearing of any radio station transmitting the signals received by such equipment;

“distance measuring equipment” means radio equipment capable of providing a continuous indication of the aircraft’s distance from the appropriate aeronautical radio stations;

“Mode A” means replying to an interrogation from secondary surveillance radar units on the surface to elicit transponder replies for identity and surveillance with identity provided in the form of a 4-digit identity code;

“Mode C” means replying to an interrogation from secondary surveillance radar units on the surface to elicit transponder replies for automatic pressure altitude transmission and surveillance;

“secondary surveillance radar equipment” means such type of radio equipment as may be notified as being capable of –

- (a) replying to an interrogation from secondary surveillance radar units on the surface; and
- (b) being operated in accordance with such instructions as may be given to the aircraft by the appropriate air traffic control unit;

“VHF omni-range equipment” means radio navigation equipment capable of giving visual indications of bearings of the aircraft by means of signals received from very high frequency omni-directional radio ranges.

ELEVENTH SCHEDULE

[Regulation 27]

AIRCRAFT, ENGINE AND PROPELLER LOG BOOKS

1. Aircraft log book

The following entries shall be included in the aircraft log book –

- (a) the name of the constructor, type of the aircraft, number assigned to it by the constructor and date of the construction of the aircraft;
- (b) the nationality and registration marks of the aircraft;
- (c) the name and address of the operator of the aircraft;
- (d) the date of every flight and duration of the period between take-off and landing, or, if more than one flight was made on that day, the number of flights and total duration of the periods between take-offs and landings on that day;
- (e) subject to subparagraph (h), particulars of all maintenance work carried out on the aircraft or its equipment;
- (f) subject to subparagraph (h), particulars of any defects occurring in the aircraft or any equipment required to be carried therein, by or under these regulations, and of the action taken to rectify such defects, including a reference to the relevant entries in the technical log required by regulation 18;
- (g) subject to subparagraph (h), particulars of any overhaul, repair, replacement and modification relating to the aircraft or any such equipment as aforesaid; and
- (h) entries shall not be required to be made under subparagraphs (e), (f) and (g) in respect of any engine or variable pitch propeller.

2. Engine log book

The following entries shall be included in the engine log book –

- (a) the name of the constructor, type of engine, number assigned to it by the constructor and date of the construction of the engine;
- (b) the nationality and registration marks of every aircraft in which the engine is fitted;

- (c) the name and address of the operator of every such aircraft;
- (d) (i) the date of every flight and duration of the period between take-off and landing or, if more than one flight was made on that day, the number of flights and the total duration of the periods between take-offs and landings on that day; or
 - (ii) the aggregate duration of periods between take-off and landing for all flights made by that aircraft since the immediately preceding occasion that any maintenance, overhaul, repair, replacement, modification or inspection was undertaken on the engine;
- (e) particulars of all maintenance work done on the engine;
- (f) particulars of any defect occurring in the engine, and rectification of such defects, including a reference to the relevant entries in the technical log required by regulation 18; and
- (g) particulars of all overhauls, repairs, replacements and modifications relating to the engine or any of its accessories.

3. Variable pitch propeller log book

The following entries shall be included in the variable pitch propeller log book –

- (a) the name of the constructor, type of propeller, number assigned to it by the constructor and date of the construction of the propeller;
- (b) the nationality and registration marks of every aircraft, and type and number of each engine, to which the propeller is fitted;
- (c) the name and address of the operator of every such aircraft;
- (d) (i) the date of every flight and the duration of the period between take-off and landing or, if more than one flight was made on that day, the number of flights and the total duration of the periods between take-offs and landings on that day; or
 - (ii) the aggregate duration of periods between take-off and landing for all flights made by that aircraft since the immediately preceding occasion that any maintenance, overhaul, repair, replacement, modification or inspection was undertaken on the propeller;
- (e) particulars of all maintenance work done on the propeller;
- (f) particulars of any defect occurring in the propeller, and rectification of such defects, including a reference to the relevant entries in the technical log required by regulation 18; and
- (g) particulars of all overhauls, repairs, replacements and modifications relating to the propeller.

TWELFTH SCHEDULE

[Regulations 33, 34 and 35]

FLIGHT CREW OF AIRCRAFT – LICENCES, RATINGS AND QUALIFICATIONS

PART I – LICENCES

1. Student Pilot's Licence (Aeroplanes)

Minimum age – 16 years

Maximum period of validity – 2 years

The licence shall –

- (a) entitle the holder to fly as pilot in command of an aircraft for the purpose of becoming qualified for the grant of a pilot's licence;
- (b) be valid only for flights within Mauritius;
- (c) not entitle the holder to fly as pilot in command of an aircraft in which any other person is carried; and
- (d) be valid only for flights carried out in accordance with instructions given by a person holding a pilot's licence granted under these regulations, being a licence which includes an appropriate rating in accordance with Part II of this Schedule entitling him to give instructions

in flying the type of aircraft being flown.

2. Private Pilot's Licence (Aeroplanes)

Minimum age – 17 years

No maximum period of validity

Privileges

(1) Subject to subparagraph (2), the holder of the licence shall be entitled to fly as pilot in command or co-pilot of an aeroplane of any of the types or classes specified or otherwise falling within an aircraft rating included in the licence.

(2) (a) He shall not fly such an aeroplane for the purpose of public transport or aerial work save that –

- (i) he may fly such an aeroplane for the purpose of aerial work which consists of –
 - (A) the giving of instruction in flying, if his licence includes a flying instructor's rating, class rating instructor rating, flight instructor rating or an assistant flying instructor's rating; or
 - (B) the conducting of flying tests for the purposes of this Schedule,

in either case in an aeroplane owned, or operated under arrangements entered into, by a flying club of which the person giving the instruction or conducting the test and the person receiving the instruction or undergoing the test are both members;

- (ii) he may fly such an aeroplane for the purpose of aerial work which consists of –

- (A) towing a glider in flight; or
- (B) a flight for the purpose of dropping of persons by parachute,

in either case in an aeroplane owned, or operated under arrangements entered into, by a flying club of which the holder of the licence and any person carried in the aeroplane or in any glider towed by the aeroplane are members.

(b) He shall not receive any remuneration for his services as a pilot on a flight save that if his licence includes a flying instructor's rating, a flight instructor rating or an assistant flying instructor's rating by virtue of which he is entitled to give instruction in flying microlight aircraft or self-launching motor gliders he may receive remuneration for the giving of such instruction or the conducting of such flying tests as are specified in sub subparagraph (a)(i) in a microlight aircraft or a self-launching motor glider.

(c) He shall not, unless his licence includes an instrument rating (aeroplane) or an instrument meteorological conditions rating (aeroplanes), fly as pilot in command of such an aeroplane –

- (i) on a flight outside controlled airspace when the flight visibility is less than 3 kilometres;
- (ii) on a special VFR flight in a control zone in a flight visibility of less than 10 kilometres except on a route or in an aerodrome traffic zone notified for the purpose of this subparagraph; or
- (iii) out of sight of the surface.

(d) He shall not fly as pilot in command of such an aeroplane at night unless his licence includes a night rating (aeroplanes).

(e) He shall not, unless his licence includes an instrument rating (aeroplane), fly as pilot in command or co-pilot of such an aeroplane flying in Class B or C airspace in circumstances which require compliance with the Instrument Flight Rules.

(f) He shall not, unless his licence includes an instrument rating (aeroplane) or an instrument meteorological conditions rating (aeroplanes), fly as pilot in command or co-pilot of such an aeroplane flying in Class D or E airspace in circumstances which require compliance with the metsollo.

(g) He shall not fly as pilot in command of such an aeroplane carrying passengers unless

within the preceding 90 days, he has made 3 take-offs and 3 landings as the sole manipulator of the controls of an aeroplane of the same type or class and if such a flight is to be carried out at night and his licence does not include an instrument rating (aeroplane), at least one of those take-offs and landings shall have been at night.

3. National Private Pilot's Licence (Aeroplanes)

Minimum age – 17 years

No maximum period of validity

Privileges and conditions

(1) Subject to subparagraph (2), the licence holder shall be entitled to fly as pilot in command of any simple single engine aeroplane, microlight aeroplane or SLMG specified or otherwise falling within an aircraft rating included in the licence.

(2) (a) (i) The licence holder shall not fly such a simple single engine aeroplane or microlight aeroplane outside Mauritius.

(ii) (A) Subject to sub sub subparagraph (B), the licence holder shall not fly such a SLMG in or over the territory of a Contracting State other than Mauritius except in accordance with permission granted by the competent authorities of that State.

(B) The licence holder may fly a SLMG outside Mauritius if his licence includes a SLMG rating and a medical certificate appropriate for such a flight.

(b) (i) Subject to sub sub subparagraph (ii), the licence holder shall not fly such an aeroplane for the purpose of public transport or aerial work.

(ii) The licence holder may fly such an aeroplane for the purpose of aerial work, which consists of towing another aeroplane or glider in flight where the aeroplane is owned, or operated under arrangements entered into, by a flying club or an organisation approved by the Authority for the purpose of this provision of which the holder of the licence and any person carried in the towing aeroplane or in any aeroplane or glider being towed are members.

(c) (i) The licence holder shall not fly as pilot in command of such a simple single engine aeroplane on a flight outside controlled airspace when the flight visibility is less than 5 kilometres.

(ii) The licence holder shall not fly as pilot in command of such a SLMG or microlight aeroplane on a flight outside controlled airspace when the flight visibility is less than 3 kilometres.

(d) The licence holder shall not fly as pilot in command of such an aeroplane on a flight outside controlled airspace –

(i) on a special VFR flight in a control zone in a flight visibility of less than 10 kilometres; or

(ii) out of sight of the surface.

(e) (i) The licence holder shall not fly as pilot in command of such a simple single engine aeroplane at night.

(ii) The licence holder shall not fly as pilot in command of such a microlight aeroplane or a SLMG at night.

(f) The licence holder shall not fly as pilot in command of such an aeroplane in circumstances which require compliance with the Instrument Flight Rules.

(g) The licence holder shall not fly as pilot in command of such an aeroplane carrying passengers unless, within the preceding 90 days, he has made 3 take-offs and 3 landings as the sole manipulator of the controls of an aeroplane of the same type.

(h) The licence holder shall not fly as pilot in command of such an aeroplane when the total number of persons carried, including the pilot, exceeds 4.

(i) The licence holder shall not fly as pilot in command of such a simple single engine aeroplane where –

(i) the aeroplane is fitted with a tricycle undercarriage;

- (ii) the aeroplane is fitted with a tail-wheel;
- (iii) the engine is fitted with a supercharger or turbo-charger;
- (iv) the engine is fitted with a variable pitch propeller;
- (v) the landing gear is retractable;
- (vi) a cabin pressurisation system is fitted; or
- (vii) the aeroplane has a maximum continuous cruising speed in excess of 140 knots indicated airspeed,

unless appropriate differences training has been completed and recorded in his personal flying logbook.

(j) The licence holder shall not fly as pilot in command of such a microlight aeroplane where –

- (i) the aeroplane has 3 axis controls and his previous training and experience has only been in an aeroplane with flexwing controls; or
- (ii) the aeroplane has flexwing controls and his previous training and experience has only been in an aeroplane with 3 axis controls,

unless appropriate differences training has been completed and recorded in his personal flying logbook.

4. Commercial Pilot's Licence (Aeroplanes)

Minimum age – 18 years

Maximum period of validity – 10 years

Privileges

(1) The licence holder shall be entitled to –

- (a) exercise the privileges of a Private Pilot's Licence (Aeroplanes) which includes an instrument meteorological conditions rating (aeroplanes) and a night rating (aeroplanes); and
- (b) fly as pilot in command of an aeroplane –
 - (i) on a special VFR flight notwithstanding that the flight visibility is less than 3 kilometres; and
 - (ii) when the aeroplane is taking off or landing at any place notwithstanding that the flight visibility below cloud is less than 1,800 metres.

(2) (a) Subject to sub subparagraph (b), the licence holder shall be entitled to fly as pilot in command of an aeroplane of a type or class on which he is so qualified and which is specified in an aircraft rating included in the licence when the aeroplane is engaged on a flight for any purpose whatsoever.

(b) (i) The licence holder shall not, unless his licence includes an instrument rating (aeroplane), fly such an aeroplane on any scheduled journey.

(ii) The licence holder shall not –

- (A) fly as pilot in command of such an aeroplane carrying passengers unless he has carried out at least 3 take-offs and 3 landings as pilot flying in an aeroplane of the same type or class or in a flight simulator, approved for the purpose of the aeroplane type or class to be used, in the preceding 90 days;
- (B) as co-pilot, serve at the flying controls in such an aeroplane carrying passengers during take-off and landing unless he has served as a pilot at the controls during take-off and landing in an aeroplane of the same type or in a flight simulator, approved for the purpose, of the aeroplane type to be used, in the preceding 90 days; or
- (C) if his licence does not include a valid instrument rating (aeroplane), act as pilot in command of such an aeroplane carrying passengers at night unless

he has carried out during the previous 90 days at least one of the take-offs and landings required in sub sub subparagraph (A) at night.

(iii) The licence holder shall not, unless his licence includes an instrument rating (aeroplane), fly any such aeroplane of which the maximum total mass authorised exceeds 2,300 kilogrammes on any flight for the purpose of public transport, except a flight beginning and ending at the same aerodrome and not extending beyond 25 nautical miles from that aerodrome.

(iv) The licence holder shall not fly such an aeroplane on a flight for the purpose of public transport unless it is certificated for single pilot operation.

(v) The licence holder shall not fly such an aeroplane on any flight for the purpose of public transport after he attains the age of 65 years unless the aeroplane is fitted with dual controls and carries a second pilot who has not attained the age of 60 years and holds an appropriate licence, under these regulations, entitling him to act as pilot in command or co-pilot of that aeroplane.

(vi) The licence holder shall not, unless his licence includes an instrument rating (aeroplane), fly as pilot in command or co-pilot of such an aeroplane flying in Class B or C airspace in circumstances which require compliance with the Instrument Flight Rules.

(3) (a) Subject to sub sub subparagraph (b), the licence holder shall be entitled to fly as pilot in command of an aeroplane of a type or class specified in an instructor's rating included in the licence on a flight for the purpose of aerial work which consists of –

- (i) the giving of instruction in flying; or
- (ii) the conducting of flying tests for the purposes of this Schedule,

in either case in an aeroplane owned, or operated under arrangements entered into, by a flying club of which the person giving the instruction or conducting the test and the person receiving the instruction or undergoing the test are both members.

(b) The licence holder shall not be entitled to exercise privileges contained in this paragraph private flight, an aerial work flight or a public transport flight pursuant to the privileges set out in subparagraph (1) or (2).

(4) The licence holder shall be entitled to fly as co-pilot of any aeroplane of a type specified in an aircraft rating included in the licence when the aeroplane is engaged on a flight for any purpose whatsoever.

(5) The licence holder shall not at any time after he attains the age of 65 years act as pilot in command or co-pilot of any aeroplane on a flight for the purpose of public transport.

5. Airline Transport Pilot's Licence (Aeroplanes)

Minimum age – 21 years

Maximum period of validity – 10 years

Privileges

The licence holder shall be entitled to exercise the privileges specified in this Schedule for Commercial Pilot's Licence (Aeroplanes) without being subject to the restriction specified in subparagraph (2)(b)(iv) of those privileges.

6. Private Pilot's Licence (Helicopters)

Minimum age – 17 years

No maximum period of validity

Privileges

(1) Subject to subparagraph (2), the licence holder shall be entitled to fly as pilot in command or co-pilot of any helicopter of a type specified in an aircraft rating included in the licence.

(2) (a) The licence holder shall not fly such a helicopter for the purpose of public transport or aerial work other than aerial work, which consists of –

- (i) the giving of instruction in flying if his licence includes a flying instructor's rating, flight instructor rating or an assistant flying instructor's rating; or

- (ii) the conducting of flying tests for the purposes of this Schedule,

in either case in a helicopter owned, or operated under arrangements entered into, by a flying club of which the person giving the instruction or conducting the test and the person receiving the instruction or undergoing the test are both members.

(b) The licence holder shall not receive any remuneration for his services as a pilot on a flight other than remuneration for the giving of such instruction or conducting of such flying tests as are specified in sub subparagraph (a).

(c) The licence holder shall not fly as pilot in command of such a helicopter at night unless his licence includes a night rating (helicopters).

(d) The licence holder shall not, unless his licence includes an instrument rating (helicopter), fly as pilot in command or co-pilot of such a helicopter flying in Class B or C airspace in circumstances which require compliance with the Instrument Flight Rules.

(e) The licence holder shall not fly as pilot in command of such a helicopter carrying passengers unless –

- (i) within the preceding 90 days he has made 3 circuits, each to include take-offs and landings as the sole manipulator of the controls of a helicopter of the same type; or
- (ii) if the privileges are to be exercised by night and his licence does not include an instrument rating, within the preceding 90 days he has made 3 circuits, each to include take-offs and landings by night as the sole manipulator of the controls of a helicopter of the same type.

7. Private Pilot's Licence (Gyroplanes)

Minimum age – 17 years

No maximum period of validity

Privileges

(1) Subject to subparagraph (2), the licence holder shall be entitled to fly as pilot in command or co-pilot of any gyroplane of a type specified in the aircraft rating included in the licence.

(2) (a) The licence holder shall not fly such a gyroplane for the purpose of public transport or aerial work other than aerial work, which consists of –

- (i) the giving of instruction in flying if his licence includes a flying instructor's rating, flight instructor rating or an assistant flying instructor's rating; or
- (ii) the conducting of flying tests for the purposes of this Schedule,

in either case in a gyroplane owned, or operated under arrangements entered into, by a flying club of which the person giving the instruction or conducting the test and the person receiving the instruction or undergoing the test are both members.

(b) The licence holder shall not receive any remuneration for his services as a pilot on a flight other than remuneration for the giving of such instruction or conducting of such flying tests as are specified in sub subparagraph (a).

(c) The licence holder shall not fly as pilot in command of such a gyroplane at night unless his licence includes a night rating (gyroplanes) and he has, within the immediately preceding 13 months carried out as pilot in command, not less than 5 take-offs and 5 landings at night.

8. Commercial Pilot's Licence (Helicopters and Gyroplanes)

Minimum age – 18 years

Maximum period of validity – 10 years

Privileges

(1) Subject to subparagraph (2), the licence holder shall be entitled to exercise the privileges of a Mauritian Private Pilot's Licence (Helicopters) or a Mauritian Private Pilot's Licence (Gyroplanes) which includes respectively a night rating (helicopters), or a night qualification (helicopter) or night rating (gyroplanes).

(2) (a) Subject to sub subparagraphs (b) and (c), the licence holder shall be entitled to fly as pilot in command of any helicopter or gyroplane on which he is so qualified and which is of a type specified in an aircraft rating included in the licence when the helicopter or gyroplane is engaged on a flight for any purpose whatsoever.

(b) (i) The licence holder shall not, unless his licence includes an instrument rating (helicopter), fly such a helicopter on any scheduled journey or on flight for the purpose of public transport other than in visual meteorological conditions.

(ii) The licence holder shall not fly such a helicopter on a flight for the purpose of public transport unless it is certificated for single pilot operation.

(iii) The licence holder shall not fly such a helicopter on any flight for the purpose of public transport after he attains the age of 65 years unless the helicopter is fitted with dual controls and carries a second pilot who has not attained the age of 60 years and holds an appropriate licence, under these regulations, entitling him to act as pilot in command or co-pilot of that helicopter.

(iv) The licence holder shall not, unless his licence includes an instrument rating (helicopter), fly as pilot in command of such a helicopter flying in Class B or C airspace in circumstances which require compliance with the Instrument Flight Rules.

(v) The licence holder shall not –

(A) fly as pilot in command of such a helicopter carrying passengers unless he has carried out at least 3 circuits, each to include take-offs and landings, as pilot flying a helicopter of the same type, or on a flight simulator of the helicopter type to be used, in the preceding 90 days; or

(B) as the holder of a helicopter licence which does not include a valid instrument rating (helicopter), act as pilot in command of such a helicopter carrying passengers at night unless, during the previous 90 days, he has carried out at least one of the take-offs and landings required in sub sub subparagraph (A) at night.

(c) (i) The licence holder shall not fly such a gyroplane on a flight for the purpose of public transport unless it is certificated for single pilot operation.

(ii) The licence holder shall not fly such a gyroplane at night unless he has, within the immediately preceding 13 months, carried out as pilot in command not less than 5 take-offs and 5 landings at night.

(iii) The licence holder shall not fly such a gyroplane on any flight for the purpose of public transport after he attains the age of 65 years.

(3) (a) Subject to sub subparagraph (b), the licence holder shall be entitled to fly as co-pilot of any helicopter or gyroplane of a type specified in an aircraft rating included in the licence when the helicopter or gyroplane is engaged on a flight for any purpose whatsoever.

(b) (i) The licence holder shall not, unless his licence includes an instrument rating (helicopter), fly as co-pilot of such a helicopter flying in Class B or C airspace in circumstances which require compliance with the Instrument Flight Rules.

(ii) The licence holder shall not, as co-pilot, serve at the flying controls in such a helicopter carrying passengers during take-off and landing unless he has served as a pilot at the controls during take-off and landing in a helicopter of the same type, or in a flight simulator of the helicopter type to be used, in the preceding 90 days.

(iii) The licence holder shall not, unless his licence includes an instrument rating (helicopter), fly as co-pilot of such a helicopter on any scheduled journey or on a flight for the purpose of public transport other than in visual meteorological conditions.

(4) The licence holder shall not, at any time after he attains the age of 65 years, act as pilot in command or co-pilot of any helicopter or gyroplane on a flight for the purpose of public transport.

9. Airline Transport Pilot's Licence (Helicopters and Gyroplanes)

Minimum age – 21 years

Maximum period of validity – 10 years

Privileges

The licence holder shall be entitled to exercise the privileges specified in this Schedule for Commercial Pilot's Licence (Helicopters and Gyroplanes) without being subject to the restrictions contained in subparagraphs (2)(b)(ii) and (c)(i) of those privileges.

10. Private Pilot's Licence (Balloons and Airships)

Minimum age – 17 years

No maximum period of validity

Privileges

(1) Subject to subparagraph (2), the licence holder shall be entitled to fly as pilot in command of any type of balloon or airship on which he is so qualified and which is specified in an aircraft rating included in the licence and co-pilot of any type of balloon or airship specified in such a rating.

(2) (a) The licence holder shall not fly such a balloon or airship for the purpose of public transport or aerial work, other than aerial work which consists of the giving of instruction in flying or conducting of flying tests in either case in a balloon or airship owned, or operated under arrangements entered into, by a flying club of which the person giving the instruction or conducting the test and the person receiving the instruction or undergoing the test are both members.

(b) The licence holder shall not receive any remuneration for his services as a pilot on a flight other than remuneration for giving such instruction or conducting such flying tests as are specified in sub subparagraph (a).

(c) The licence holder shall not fly such a balloon unless he has, within the immediately preceding 13 months, carried out as pilot in command in free balloon 5 flights each of not less than 5 minutes duration.

11. Commercial Pilot's Licence (Balloons)

Minimum age – 18 years

Maximum period of validity – 10 years *

Privileges

(1) The licence holder shall be entitled to exercise the privileges of a Private Pilot's Licence (Balloons and Airships).

(2) (a) Subject to sub subparagraph (b), the licence holder shall be entitled to fly, when the balloon is flying for any purpose whatsoever, as pilot in command or co-pilot of any type of balloon specified in the aircraft rating included in the licence.

(b) The licence holder shall not act as pilot in command of a balloon on a flight for the purpose of the public transport of passengers unless he has, within the immediately preceding 90 days, carried out as pilot in command in a free balloon 3 flights each of not less than 5 minutes duration.

*In respect of the privileges of a Private Pilot's licence, the maximum period of validity shall be as given for that licence.

12. Commercial Pilot's Licence (Airships)

Minimum age – 18 years

Maximum period of validity – 10 years

Privileges

(1) The licence holder shall be entitled to exercise the privileges of a Private Pilot's Licence (Balloons and Airships).

(2) The licence holder shall be entitled to fly, when the airship is flying for any purpose whatsoever, as pilot in command of any type of airship on which he is so qualified and which is specified in an aircraft rating included in the licence and as co-pilot of any type of airship specified in such a rating.

13. Commercial Pilot's Licence (Gliders)

Minimum age – 18 years

Maximum period of validity – 10 years

Privileges

The licence holder shall be entitled to fly for any purpose as pilot in command or co-pilot of –

- (a) any glider of which the maximum total authorised mass does not exceed 680 kilogrammes;
- (b) any glider of which the maximum total authorised mass exceeds 680 kilogrammes and which is of a type specified in the aircraft rating included in the licence.

14. Flight Navigator's Licence

Minimum age – 21 years

Maximum period of validity – 10 years

Privileges

The licence holder shall be entitled to act as flight navigator in any aircraft.

15. Flight Engineer's Licence

Minimum age – 21 years

Maximum period of validity – 10 years

Privileges

The licence holder shall be entitled to act as flight engineer in any type of aircraft specified in an aircraft rating included in the licence.

16. Flight Radiotelephony Operator's Licence

Minimum age – 16 years

Maximum period of validity – 10 years

Privileges

The licence holder shall be entitled to operate radiotelephony apparatus in any aircraft if the stability of the frequency radiated by the transmitter is maintained automatically but shall not be entitled to operate the transmitter, or to adjust its frequency, except by the use of external switching devices.

PART II – RATINGS

1. The following ratings may be included in a pilot's licence and, subject to this Schedule and the provisions of the licence, the inclusion of a rating in a licence shall have the consequences respectively specified hereunder

(1) Aircraft rating, when included in the licence, shall entitle the holder to act as pilot of aircraft of the types and classes specified in the rating and different types and classes of aircraft may be specified in respect of different privileges of a licence.

(2) Instrument meteorological conditions rating (aeroplanes) shall –

- (a) subject to sub subparagraph (c), entitle the holder of a Private Pilot's Licence (aeroplanes) to fly as pilot in command of an aeroplane without being subject to the restrictions contained in subparagraphs (2)(c) and (f) of the privileges of the Private Pilot's Licence (Aeroplanes);
- (b) subject to sub subparagraph (c), entitle the holder of a National Private Pilot Licence (aeroplanes) to fly as pilot in command of an aeroplane without being subject to the restrictions specified in subparagraph (2)(d) and (f) of the privileges of the National PPL;
- (c) the licence holder shall not fly –
 - (i) on a special VFR flight in a control zone in a flight visibility of less than 3 kilometres;
 - (ii) when the aeroplane is taking off or landing at any place if the flight visibility below cloud is less than 1,800 metres.

(3) Instrument rating (aeroplane) shall entitle the licence holder to act as pilot in command or co-pilot of an aeroplane flying in controlled airspace in circumstances which require the Instrument Flight Rules to be complied with.

(4) Instrument rating (helicopter) shall entitle the licence holder to act as pilot in command or co-pilot of a helicopter flying in controlled airspace in circumstances which require the Instrument Flight Rules to be complied with.

(5) Microlight class rating (National PPL) shall, when included in the aircraft rating of a National Private Pilot's Licence (Aeroplanes) and subject to the conditions of the licence in which it is included, entitle the holder to act as pilot in command of any microlight aeroplane.

(6) Night rating (aeroplanes) shall entitle the holder of a Private Pilot's Licence (Aeroplanes) to act as pilot in command of an aeroplane at night.

(7) Night rating (helicopters) shall entitle the holder of a Private Pilot's Licence (Helicopters) to act as pilot in command of a helicopter at night.

(8) Night rating (gyroplanes) shall entitle the holder of a Private Pilot's Licence (Gyroplanes) to act as pilot in command of a gyroplane at night.

(9) Simple single engine aeroplane (National PPL) class rating shall, when included in the aircraft rating of a National Private Pilot's Licence (Aeroplanes) and subject to the conditions of that licence, entitle the holder to act as pilot in command of any simple single engine aeroplane with a maximum take-off weight authorised not exceeding 2,000 kilogrammes, excluding any such aeroplane which is a self-launching motor glider or a microlight aeroplane.

(10) SLMG class rating (National PPL) shall, when included in the aircraft rating of National Private Pilot's Licence (Aeroplanes) and subject to the conditions of the licence in which it is included, entitle the holder to act as pilot in command of any SLMG.

(11) Towing rating (flying machines) shall entitle the licence holder to act as pilot of a flying machine while towing a glider in flight for the purpose of public transport or aerial work.

(12) Flying instructor's rating shall entitle the licence holder to give instruction in flying aircraft of such types and classes as may be specified in the rating for that purpose.

(13) (a) Assistant flying instructor's rating shall, subject to sub subparagraph (b), entitle the licence holder to give instruction in flying aircraft of such types and classes as may be specified in the rating for that purpose.

(b) (i) The instruction referred to in sub subparagraph (a) shall only be given under the supervision of a person present during the take-off and landing at the aerodrome at which the instruction is to begin and end and holding a pilot's licence endorsed with a flying instructor's rating.

(ii) An assistant flying instructor's rating shall not entitle the licence holder to give directions to the person undergoing instruction in respect of the performance by that person of his first solo –

- (A) flight;
- (B) flight by night;
- (C) cross-country flight otherwise than by night; or
- (D) cross-country flight by night.

(14) Flight instructor rating (aeroplane) shall, subject to the restrictions specified in subparagraph (15), entitle the licence holder to give instruction in flying aircraft of such types and classes as may be specified in the rating for that purpose.

(15) Flight instructor rating (aeroplane)

(a) (i) The privileges of the rating shall, unless the holder of a flight instructor has –

- (A) completed not less than 100 hours flight instruction; and
- (B) supervised not less than 25 solo flights,

be restricted.

(ii) The restrictions shall be removed from the rating where the above requirements have been met and on the recommendation of the supervising flight instructor (aeroplane).

(b) The privileges shall be restricted to carrying out under the supervision of the holder of a flight instructor (aeroplane) rating approved for the following purposes –

- (i) flight instruction for the issue of the Private Pilot Licence (Aeroplanes) or those parts of integrated courses at Private Pilot Licence (Aeroplanes) level and class and type ratings for single engine aeroplanes, excluding approval of first solo flights by day or by night and first solo cross country flights by day or by night; and
- (ii) night flying instruction.

(16) Flight instructor rating (helicopter) shall, subject to the restrictions specified in subparagraph (17), entitle the licence holder to give instruction in flying helicopters of such types as may be specified in the rating for that purpose.

(17) Flight instructor rating (helicopter)

(a) (i) Until the holder of a flight instructor (helicopter) rating has completed at least 100 hours flight instruction and, in addition, has supervised at least 25 solo flights by students, the privileges of the rating shall be restricted.

(ii) The restrictions shall be removed from the rating where the above requirements have been met and on the recommendation of the supervising flight instructor (helicopter).

(b) The privileges shall be restricted to carrying out under the supervision of the holder of a flight instructor (helicopter) rating approved for this purpose –

- (i) flight instruction for the issue of the Private Pilot Licence (Helicopter) or those parts of integrated courses at Private Pilot Licence (Helicopter) level and type ratings for single engine helicopters, excluding approval of first solo flights by day or night and first solo cross-country flights by day or by night; and
- (ii) night flying instruction.

(18) Type rating instructor rating (multi-pilot aeroplane) shall entitle the holder to instruct licence holders for the issue of a multi-pilot aeroplane type rating, including the instruction required for multi-crew co-operation.

(19) Type rating instructor rating (helicopter) shall entitle the holder to instruct licence holders for the issue of a helicopter type rating, including the instruction required for multi-crew co-operation, as applicable.

(20) Class rating instructor rating (single-pilot aeroplane) shall entitle the holder to instruct licence holders for the issue of a type or class rating for single-pilot aeroplanes.

(21) Instrument rating instructor rating (aeroplane) shall entitle the holder to conduct flight instruction for the issue of an instrument rating (aeroplane) or instrument meteorological conditions rating (aeroplane).

(22) Instrument rating instructor rating (helicopter) shall entitle the holder to conduct flight instruction for the issue of an instrument rating (helicopter).

2. An aircraft rating included in a flight engineer's licence shall entitle the licence holder to act as flight engineer only of aircraft of a type specified in the aircraft rating.

3. In this Schedule –

“simple single engine aeroplane” means, for the purposes of the National Private Pilot's Licence, a single engine piston aeroplane with a maximum take-off authorised mass not exceeding 2,000 kilogrammes and which is not a microlight aeroplane or self-launching motor glider.

PART III – MAINTENANCE OF PRIVILEGES

Sub-Part A – Requirement for Certificate of Test or Experience

1. General

(1) A certificate of test or certificate of experience required by regulation 34 or 35 shall not be appropriate to the functions to be performed on a flight unless it is a certificate appropriate to the

description of the flight according to the table set out hereunder.

Case	Class of national licence	Description of flight	Certificate required
A	Microflight Licence SLMG Licence Private Pilot's Licence (Gyroplane)	Any flight within the privileges of the licence	Certificate of test or certificate of experience
B	Commercial Pilot's Licence (Helicopter and Gyroplane) Commercial Pilot's Licence (Balloon) Commercial Pilot's Licence (Glider) Commercial Pilot's Licence (Airship) Airline Transport Pilot's Licence (Helicopter and Gyroplane)	Carriage of passengers on a flight in respect of which the licence holder receives remuneration	Certificate of test
C	Commercial Pilot's Licence (Helicopter and Gyroplane) Commercial Pilot's Licence (Balloon) Commercial Pilot's Licence (Glider) Commercial Pilot's Licence (Airship) Airline Transport Pilot's Licence (Helicopter and Gyroplane)	For public transport	Certificate of test
D	Commercial Pilot's Licence (Helicopter and Gyroplane) Commercial Pilot's Licence (Balloon) Commercial Pilot's Licence (Glider) Commercial Pilot's Licence (Airship) Airline Transport Pilot's Licence (Helicopter and Gyroplane)	For aerial work	Certificate of test or certificate of experience
E	Commercial Pilot's Licence (Helicopter and Gyroplane) Commercial Pilot's Licence (Balloon) Commercial Pilot's Licence (Glider) Commercial Pilot's Licence (Airship) Airline Transport Pilot's Licence (Helicopter and Gyroplane)	Any flight within the privileges of a Private Pilot's Licence	Certificate of test or certificate of experience
F	Flight Navigator's Licence	Flights to which regulation 30(6) applies	Certificate of experience

(2) For the purpose of this Part of this Schedule, references to Cases are references to the Cases specified in the first column of the table set out in subparagraph (1).

2. Certificate of test

A certificate of test required by regulation 34 or 35 shall be signed by a person authorised by the Authority to sign certificates of this kind and shall certify –

- (a) the functions to which the certificate relates;
- (b) that the person signing the certificate is satisfied that on a date specified in the certificate, the licence holder or personal flying logbook of which the certificate forms part, as the case may be, passed an appropriate test of his ability to perform the functions to which the certificate relates;
- (c) the type of aircraft or flight simulator in or by means of which the test was conducted; and
- (d) the date on which it was signed.

3. Nature of test

The appropriate test referred to in paragraph 2 shall be –

- (a) in the case of a test which entitles the licence holder of which the certificate forms part to act as pilot in command and/or co-pilot of aircraft of the type, or class specified in the certificate, a test of the pilot's competence to fly the aircraft as pilot in command and/or co-pilot and shall, where the Authority so specifies in respect of the whole or part of a test, be conducted in an aircraft in flight or by means of a flight simulator approved by the Authority;
- (b) in the case of a test which entitles the licence holder of which the certificate forms part to perform the functions to which a flying instructor's rating (gyroplanes), an assistant flying instructor's rating (gyroplanes) or instrument meteorological conditions rating (aeroplanes) relates, a test of his ability to perform the functions to which the rating relates and shall, where the Authority so specifies in respect of the whole or part of the test, be conducted in an aircraft in flight.

4. Period of validity of certificate of test

(1) (a) Subject to sub subparagraph (b), a certificate of test required by regulation 34 in respect of a Commercial Pilot's Licence (Balloon) shall not be valid in relation to a flight made more than 13 months after the date of the test which it certifies and, in respect of any other licence, shall not be valid in relation to a flight made more than 13 months in Cases A, B and E or more than 6 months in Cases C and D after the date of the test which it certifies.

(b) In the case of Cases C and D, 2 certificates of test shall, together, constitute a valid certificate of test if they certify flying tests conducted on 2 occasions within the period of 13 months preceding the flight on which the functions are to be performed, such occasions being separated by an interval of not less than 4 months, and if both certificates are appropriate to those functions.

(2) (a) A certificate of test required by regulation 35 in respect of an instrument meteorological conditions rating (aeroplanes) shall not be valid in relation to a flight made more than 25 months after the date of the test which it certifies.

(b) A certificate of test required by regulation 35 in respect of an assistant flying instructor's rating (gyroplanes) and a flying instructor's rating (gyroplanes) shall not be valid in relation to a flight made more than 3 years after the date of the test which it certifies.

5. Certificate of experience

A certificate of experience required by regulation 34 shall be signed by a person authorised by the Authority to sign such a certificate and shall certify –

- (a) the functions to which the certificate relates;
- (b) in the case of a pilot, that on the date on which the certificate was signed, the licence holder or personal flying log book of which it forms part, as the case may be, produced his personal flying log book to the person signing the certificate and satisfied him that he had appropriate experience in the capacity to which his licence relates within the appropriate period specified in paragraph 6 of this Part of this Schedule;
- (c) in the case of a flight navigator, that on the date on which the certificate was signed, the licence holder of which it forms part produced his navigation logs, charts and workings of astronomical observations to the person signing the certificate and satisfied him that he had appropriate experience in the capacity to which the licence relates, within the appropriate period specified in paragraph 6 of this Part of this Schedule;

- (d) in the case of a pilot, the type or types of aircraft in which the experience was gained; and
- (e) the date on which it was signed.

6. Period of experience

A certificate of experience shall not be valid unless the experience was gained within the period of 13 months preceding the signing of the certificate in the case of Cases A, E and F or 6 months preceding the signing of the certificate in the case of Case D.

7. Period of validity of certificate of experience

A certificate of experience in respect of a Commercial Pilot's Licence (Balloon) shall not be valid for more than 13 months after it was signed and in respect of any other licence shall not be valid for more than 6 months after it was signed for Case D nor for more than 13 months after it was signed for any other case.

Sub-Part B – Requirement for Certificate of Revalidation

1. Appropriate certificate of revalidation

A certificate of revalidation required by regulation 34 or 35 shall not be appropriate to the exercise of the privileges of a flight crew licence unless it is a certificate, which accords with this Sub-part.

2. Type and class ratings

(1) Aeroplane type and class ratings –

(a) Type ratings and multi-engine class ratings, aeroplane

(i) Validity

Type ratings and multi-engine class ratings for aeroplanes are valid for one year from the date of issue, or the date of expiry if revalidated within a period of 3 months preceding the date of expiry.

(ii) Revalidation

For revalidation of type ratings and multi-engine class ratings for aeroplanes, the applicant shall satisfy the requirements specified in paragraph 1.245(a) and (b) of JAR – FCL 1.

(b) Single pilot engine class ratings

(i) Validity

Single pilot engine class ratings shall be valid for a period of 2 years from the date of issue, or date of expiry, if revalidated within a period of 3 months preceding the date of expiry.

(ii) (A)

All single engine piston aeroplane class ratings (land) and all touring motor glider ratings – Revalidation

For revalidation of single pilot engine piston aeroplane (land) class ratings, the applicant shall, on single engine piston aeroplanes (land), satisfy the requirements specified in paragraph 1.245(c)(1) of JAR – FCL 1.

(B) Single engine turbo-prop aeroplanes (land) single-pilot – revalidation

For revalidation of single engine turbo-prop (land) class ratings, the applicant shall, within the 3 months preceding the expiry date of the rating, pass a proficiency check with an authorised examiner on an aeroplane in the relevant class.

(C) Single engine piston aeroplanes (sea) – revalidation

For revalidation of single pilot engine piston aeroplane (sea) class ratings, the applicant shall –

- (I) within the 3 months preceding the expiry date of the rating, pass a proficiency check with an authorised examiner on a single engine piston aeroplane (sea);or

- (II) within 12 months preceding the expiry of the rating –

- (AA) complete 12 hours of flight time, including 6 hours of pilot in command time on a single engine piston aeroplane (sea) or single

engine piston aeroplane (land) and 12 water take-offs and 12 alightings on water; and

(AB) complete a training flight of at least one hour duration with a flight instructor or pass a proficiency check or skill test for any other class or type rating.

(c) Expired ratings

(i) Where a type rating or multi engine class rating has expired, the applicant shall comply with paragraph (b) and meet any refresher training requirements as determined by the Authority. The rating will be valid from the date of completion of the renewal requirements.

(ii) If a single pilot engine class rating has expired, the applicant shall complete the skill test in accordance with the requirements specified in the Third Schedule to paragraph 1.240 of JAR – FCL 1.

(2) Helicopter type ratings –

(a) Type ratings, helicopter – validity

Type ratings for helicopters shall be valid for one year from the date of issue, or the date of expiry if revalidated within the period of 3 months preceding the date of expiry.

(b) Type ratings, helicopter – revalidation

For revalidation of type ratings, helicopter, the applicant shall complete the requirements specified in paragraph 2.245(b) of JAR – FCL 2.

(c) Expired ratings

Where a type rating has expired, the applicant shall comply with paragraph (b) and meet any refresher training requirements as determined by the Authority. The rating will be valid from the date of completion of the renewal requirements.

(3) Flight engineer type ratings

(a) Type ratings – validity

Flight engineer type ratings shall be valid for one year from the date of issue, or the date of expiry if revalidated within the period of 3 months preceding the date of expiry.

(b) Type ratings – revalidation

For revalidation of flight engineer type ratings, the applicant shall, within the 3 months preceding the date of expiry of the rating, pass a proficiency check with an authorised examiner on the relevant type of aircraft.

3. Forms of certificate of revalidation

(1) A certificate of revalidation required by regulation 34 or 35 shall be signed by a person authorised by the Authority to sign such certificates and shall certify –

(a) the functions to which the certificate relates;

(b) that the person signing the certificate is satisfied that on a date specified in the certificate, the licence holder of which the certificate forms part, met the appropriate requirements for revalidation specified in respect of the rating, in the case of an aircraft rating in paragraph 2 and in the case of any other rating specified in the table at subparagraph (2) below, to exercise the privileges of the licence or rating to which the certificate relates;

(c) the type of aircraft or flight simulator in or by means of which the test was conducted; and

(d) the date on which it was signed.

(2) The requirements for revalidation of a rating are as set out in the following table hereunder.

Rating	Paragraph in JAR – FCL
--------	------------------------

Instrument rating (aeroplane)	1.185
Instrument rating (helicopter)	2.185
Flight instructor (aeroplane)	1.355
Flying instructor's rating (aeroplanes)	
Assistant flying instructor's rating (aeroplanes)	
Flight instructor (helicopter)	2.355
Flying instructor's rating (helicopters)	
Assistant flying instructor's rating (helicopters)	
Type rating instructor rating (multi-pilot aeroplane)	1.370
Type ratings instructor rating (helicopter)	2.370
Class rating instructor rating (single pilot aeroplane)	1.385
Instrument rating instructor rating (aeroplane)	1.400
Instrument rating instructor rating (helicopter)	2.4000

Sub-Part C – Maintenance of Validity of National Private Pilot's Licence (Aeroplanes)

1. A simple single engine aeroplane (NPPL) class rating included in a National Private Pilot's Licence (Aeroplane) shall not be valid for the purposes of regulation 34 unless this Sub-part have been complied with.
2. A simple single engine aeroplane (NPPL) class rating shall be valid if –
 - (a) the holder has, within the 12 months preceding the flight, flown not less than 6 hours in an aeroplane falling within the simple single engine aeroplane (NPPL) class rating, 4 hours of which shall have been as pilot in command and he has carried out a training flight of at least one hour duration with a flying instructor within the previous 24 months; or
 - (b) he has, within the 3 months preceding the expiry of the rating, undertaken a simple single engine aeroplane (NPPL) general skills test.

THIRTEENTH SCHEDULE

[Regulations 41, 42(2), and 43(3)]

PUBLIC TRANSPORT – OPERATIONAL REQUIREMENTS

PART I – OPERATIONS MANUAL

1. Information and instructions relating to the following matters shall be included in the operations manual referred to in regulation 41(2) –
 - (a) the number of the crew to be carried in the aircraft, on every stage of any route to be flown,

and the respective capacities in which they are to act, and instructions as to the order and circumstances in which command is to be assumed by members of the crew;

- (b) the respective duties of every member of the crew and other members of the operating staff;
- (c) the scheme for avoiding crew fatigue established under regulation 78;
- (d) such technical particulars concerning the aircraft, its engines and equipment and the performance of the aircraft, as may be necessary, to enable the flight crew of the aircraft to perform their respective duties;
- (e) the manner in which the quantities of fuel and oil to be carried by the aircraft are to be computed and records of fuel and oil carried and consumed on every stage of the route to be flown are to be maintained; the instructions shall take account of all circumstances likely to be encountered on the flight, including the possibility of failure of one or more of the aircraft engines;
- (f) the manner in which the quantity, if any, of oxygen and oxygen equipment to be carried in the aircraft for the purpose of complying with Scales L1 and L2 in the Seventh Schedule is to be computed;
- (g) the check system to be followed by the crew of the aircraft prior to and on take-off, landing and in an emergency, to ensure that the operating procedures specified in the operations manual and flight manual or performance schedule forming part of the relevant certificate of airworthiness are complied with;
- (h) the circumstances in which a radio watch is to be maintained;
- (i) the circumstances in which oxygen is to be used by the crew of the aircraft, and by passengers;
- (j) subject to paragraph 2, communication, navigational aids, aerodromes, local regulations, in-flight procedures, approach and landing procedures and such other information as the operator may consider necessary for the proper conduct of flight operations. The information referred to in this subparagraph shall be specified in a route guide which may be in the form of a separate volume;
- (k) the reporting in flight to the notified authorities of meteorological observations;
- (l) subject to paragraph 2, the minimum altitudes for safe flight on every stage of the route to be flown and any planned diversion therefrom, such minimum altitudes being not lower than any minimum altitude which may be applicable under the law of Mauritius or of the countries whose territory is to be flown over;
- (m) the particulars of aerodrome operating minima established under regulation 46;
- (n) emergency flight procedures, including procedures for the instruction of passengers in the position and use of emergency equipment and procedures to be adopted when the commander of the aircraft becomes aware that another aircraft or a vessel is in distress and needs assistance;
- (o) in the case of aircraft intended to fly at an altitude of more than 49,000 feet, the procedures for the use of cosmic radiation detection equipment for complying with regulation 82;
- (p) the labelling and marking of dangerous goods, the manner in which they shall be loaded on or suspended beneath an aircraft, responsibilities of members of the crew in respect of the carriage of dangerous goods and action to be taken in the event of emergencies arising involving dangerous goods;
- (q) such particulars of any permission granted to the operator pursuant to regulation 24, as may be necessary, to enable the commander of the aircraft to determine whether he may comply with regulation 49;
- (r) procedures for the operation of any airborne collision avoidance system carried on the aircraft;
- (s) the establishment and maintenance of an accident prevention and flight safety programme.

2. In relation to any flight which is not one of a series of flights between the same 2 places, it shall

be sufficient if, to the extent that it is not practicable to comply with paragraphs 1(j) and (l), the manual contains such information and instructions as will enable the equivalent data to be ascertained before take-off.

PART II – CREW TRAINING AND TESTS

1. The training, experience, practice and periodical tests specified in regulation 43, in the case of members of the crew of an aircraft engaged on a flight for the purpose of public transport, shall be as specified in this paragraph.

(1) The crew

Every member of the crew shall –

- (a) have been tested within the relevant period by or on behalf of the operator as to his knowledge of the use of the emergency and life saving equipment required to be carried in the aircraft on the flight; and
- (b) have practised within the relevant period under the supervision of the operator, or a person appointed by him for the purpose, the carrying out of the duties required by him in case of an emergency occurring to the aircraft, in an aircraft of the type to be used on the flight or in an apparatus approved by the Authority for the purpose and controlled by persons so approved.

(2) Pilots

(a) Every pilot included in the flight crew who is intended by the operator to fly as pilot in circumstances requiring compliance with the Instrument Flight Rules, shall within the relevant period, have been tested by or on behalf of the operator, as to his competence to perform his duties –

- (i) while executing normal manoeuvres and procedures in flight, in an aircraft of the type to be used on the flight, including the use of the instruments and equipment provided in the aircraft; and
- (ii) in instrument flight conditions while executing emergency manoeuvres and procedures in flight, in an aircraft of the type to be used on the flight, including the use of the instruments and equipment provided in the aircraft.

(b) Every pilot, included in the flight crew, whose licence does not include an instrument rating or who, notwithstanding the inclusion of such a rating in his licence, is not intended by the operator to fly in circumstances requiring compliance with the Instrument Flight Rules, shall, within the relevant period, have been tested, by or on behalf of the operator, in flight in an aircraft of the type to be used on the flight as to his competence to act as pilot thereof, while executing –

- (i) normal manoeuvres and procedures; and
- (ii) emergency manoeuvres and procedures.

(c) Every pilot included in the flight crew who is seated at the flying controls during the take-off or landing and who is intended by the operator to fly as pilot in circumstances requiring compliance with the Instrument Flight Rules shall, within the relevant period, have been tested as to his proficiency in using instrument approach to land systems of the type in use at the aerodrome of intended landing and any alternate aerodromes.

(d) In the case of a helicopter, every pilot included in the flight crew whose licence does not include an instrument rating, but who is intended to fly at night under visual flight conditions, shall, within the relevant period have been tested, by or on behalf of the operator, in a helicopter of the type to be used on the flight as to his competence to act as pilot thereof, while executing –

- (i) normal manoeuvres and procedures; and
- (ii) specified manoeuvres and procedures in flight in instrument flight conditions by means approved by the Authority.

(e) Every pilot included in the flight crew, and who is seated at the flying controls during take-off or landing, shall within the relevant period have carried out, when seated at the flying controls not less than 3 take-offs and 3 landings in aircraft of the type to be used on the flight.

(f) A pilot's ability to carry out normal manoeuvres and procedures shall be tested in the

aircraft in flight.

(g) The test required under this subparagraph may be conducted in the aircraft in flight, or under the supervision of a person approved by the Authority for the purpose by means of a flight simulator approved by the Authority. The tests specified in subparagraph (2)(a)(ii) and (c) when conducted in the aircraft in flight, shall be carried out either in actual instrument flight conditions or in instrument flight conditions simulated by means approved by the Authority.

(3) Flight engineers

(a) Every flight engineer included in the flight crew shall, within the relevant period, have been tested by or on behalf of the operator as to his competence to perform his duties while executing –

- (i) normal procedures in flight, in an aircraft of the type to be used on the flight;
- (ii) emergency procedures in flight, in an aircraft of the type to be used on the flight.

(b) (i) A flight engineer's ability to carry out normal procedures shall be tested in an aircraft in flight.

(ii) The other test required by this subparagraph may be conducted in the aircraft in flight, or under the supervision of a person approved by the Authority for the purpose by means of a flight simulator approved by the Authority.

(4) Flight navigators and flight radiotelephony operators

Every flight navigator and flight radiotelephony operator whose inclusion in the flight crew is required under regulation 30 shall, within the relevant period, have been tested by or on behalf of the operator as to his competence to perform his duties in conditions corresponding to those likely to be encountered on the flight, in the case of –

- (a) a flight navigator, using equipment of the type to be used in the aircraft on the flight for purposes of navigation;
- (b) a flight radiotelephony operator using radio equipment of the type installed in the aircraft to be used on the flight, and, including a test of his ability to carry out emergency procedures.

(5) Aircraft commanders

(a) The pilot designated as commander of the aircraft for the flight shall, within the relevant period, have demonstrated to the satisfaction of the operator that he has adequate knowledge of the route to be taken, the aerodromes of take-off and landing, and any alternate aerodromes, including in particular his knowledge of –

- (i) the terrain;
- (ii) the seasonal meteorological conditions;
- (iii) the meteorological, communications and air traffic facilities, services and procedures;
- (iv) the search and rescue procedures; and
- (v) the navigational facilities,

relevant to the route.

(b) In determining whether a pilot's knowledge of the matters referred to in sub paragraph (a)(i) is sufficient to render him competent to perform the duties of aircraft commander on the flight, the operator shall take into account the pilot's flying experience in conjunction with –

- (i) the experience of other members of the intended flight crew;
- (ii) the influence of terrain and obstructions on departure and approach procedures at the aerodromes of take-off and intended landing and at alternate aerodromes;
- (iii) the similarity of the instrument approach procedures and let-down aids to those with which the pilot is familiar;
- (iv) the dimensions of runways, which may be used in the course of the flight in

relation to the performance limits of aircraft of the type to be used on the flight;

- (v) the reliability of meteorological forecasts and probability of difficult meteorological conditions in the areas to be traversed;
- (vi) the adequacy of the information available regarding the aerodrome of intended landing and any alternate aerodromes;
- (vii) the nature of air traffic control procedures and familiarity of the pilot with such procedures;
- (viii) the influence of terrain on route conditions and the extent of the assistance obtainable en route from navigational aids and air-to-ground communication facilities; and
- (ix) the extent to which it is possible for the pilot to become familiar with unusual aerodrome procedures and features of the route by means of ground instruction and training devices.

(6) (a) In this Part –

“instrument flight conditions” means weather conditions such that the pilot is unable to fly by visual reference to objects outside the aircraft;

“relevant period” means a period which immediately precedes the commencement of the flight, being subject to sub subparagraph (b), a period –

- (i) in the case of subparagraph (2)(e), of 3 months;
- (ii) in the case of subparagraphs (2)(a)(ii), (b)(ii),(c), (d)(ii) and (3)(a)(ii), of 6 months;
- (iii) in the case of subparagraphs (1), (2)(a),(b)(i), (d)(i), (3)(a)(i), (4) and (5)(a), of 13 months;

“visual flight conditions” means weather conditions such that the pilot is able to fly by visual reference to objects outside the aircraft.

(b) For the purpose of this Part –

(i)

any pilot of the aircraft to whom subparagraphs (2)(a)(ii), (b)(ii) or (c) and any flight engineer of the aircraft to whom subparagraph (3)(a)(ii) apply shall, for the purposes of the flight, be deemed to have complied with such requirements, respectively, within the relevant period if he has qualified to perform his duties in accordance therewith on 2 occasions within the period of 13 months immediately preceding the flight, such occasions being separated by an interval of not less than 4 months;

(ii)

the requirements of subparagraph (5)(a) shall be deemed to have been complied with within the relevant period by a pilot designated as commander of the aircraft for the flight if, having become qualified to act on flights between the same places over the same route more than 13 months before the commencement of the flight, he has within the period of 13 months immediately preceding the flight, flown as pilot of an aircraft between those places over that route.

2. (1) The records required to be maintained by an operator under regulation 43(3) shall be accurate and up to date to show, on any date, in relation to every person who has, during the period of 2 years immediately preceding that date, flown as a member of the crew of any public transport aircraft operated by that operator –

- (a) the date and particulars of every test required by this Schedule undergone by that person during the said period, including the name and qualifications of the examiner;
- (b) the date on which that person last practised the carrying out of duties referred to in paragraph 1(1)(b);
- (c) the operator’s conclusions based on every such test and practice as to that person’s competence to perform his duties;
- (d) the date and particulars of any decision taken by the operator during the said period in pursuance of subparagraph (5)(a), including particulars of the evidence on which that decision was based.

(2) The operator shall, whenever called upon to do so by any authorised person, produce for the inspection of any person so authorised, all records referred to in the subparagraph (1) and furnish to any such person all such information as he may require in connection with any such record and produce for his inspection all log books, certificates, papers and other documents, whatsoever which he may reasonably require to see for the purpose of determining whether such records are complete, or of verifying the accuracy of their contents.

(3) The operator shall, at the request of any person in respect of whom he is required to keep records as specified in subparagraph (2), furnish to that person, or any operator of aircraft for the purpose of public transport by whom that person may subsequently be employed, particulars of any qualification, in accordance with this Schedule, obtained by such person whilst in his service.

PART III – TRAINING MANUAL

The following information and instructions in relation to the training, experience, practice and periodical tests required under regulation 43(3) shall be included in the training manual referred to in regulation 42(2) –

- (a) the manner in which the training, practice and periodical tests required under regulation 43(3) and specified in Part II of this Schedule are to be carried out;
- (b) with respect to the persons appointed by the operator to give or supervise training, practice and periodical tests –
 - (i) the minimum qualifications and experience which the operator requires of persons appointed by him to give or supervise the said training, practice and periodical tests;
 - (ii) the type of training, practice and periodical tests which every such person is appointed to give or supervise; and
 - (iii) the type of aircraft in respect of which every such person is appointed to give or supervise the said training, practice and periodical tests;
- (c) the minimum qualifications and experience required for every member of the crew undergoing the said training, practice and periodical tests;
- (d) the syllabus for, and specimen forms for recording the said training, practice and periodical tests;
- (e) the manner in which instrument flight conditions and engine failure are to be simulated in the aircraft in flight;
- (f) the extent to which the said training and testing is permitted in the course of flights for the purpose of public transport;
- (g) the use to be made in the said training and testing of apparatus approved for the purpose by the Authority.

FOURTEENTH SCHEDULE

[Regulations 81 and 83]

DOCUMENTS TO BE CARRIED BY AIRCRAFT REGISTERED IN MAURITIUS

1. On a flight for the purpose of public transport
Documents A, B, C, D, E, F, G, H, K and, if the flight is international air navigation, Document I
2. On a flight for the purpose of aerial work
Documents A, B, C, E, F, G and, if the flight is international air navigation, Document I
3. On a private flight
Documents A, B, C, G and, if the flight is international air navigation, Document I.
4. On a flight made in accordance with the terms of a permission granted to the operator pursuant to regulation 24
Documents required under paragraph 1, 2 or 3, as may be applicable, and Document J

5. (1) In this Schedule –

“A” means –

- (a) the licence in force in respect of the aircraft radio station installed in the aircraft; and
- (b) the current telecommunications logbook required by these regulations;

“B” means the certificate of airworthiness in force in respect of the aircraft;

“C” means the licences of the members of the flight crew of the aircraft;

“D” means the load sheet as required by regulation 44 in respect of the flight;

“E” means one copy of every certificate of maintenance review, if any, in force in respect of the aircraft;

“F” means the technical log, if any, in which entries are required to be made under regulation 18;

“G” means the certificate of registration in force in respect of the aircraft;

“H” means those parts of the operations manual, if any, required by regulation 41(2)(c) to be carried on the flight;

“I” means a copy of the notified procedures to be followed by the pilot in command of an intercepted aircraft, and the notified visual signals for use by intercepting and intercepted aircraft;

“J” means the permission, if any, granted in respect of the aircraft pursuant to regulation 24;

“K” means a copy of the air operator certificate issued under regulation 11:

“international air navigation” means any flight which includes passage over the territory of any country other than Mauritius, including Rodrigues, Agalega and St. Brandon Islands.

(2) With the permission in writing of the Authority, which may be granted subject to such conditions as it may determine, an aircraft to which regulation 41 applies need not carry the flight manual as part of Document B.

(3) With the permission in writing of the Authority, which may be granted subject to such conditions as it may determine, an aircraft to which regulation 41 applies need not carry a permission in Document J if it carries an operations manual which includes the particulars specified at paragraph 1(q) of Part I of the Thirteenth Schedule.

FIFTEENTH SCHEDULE

[Regulations 46(10), 87 and 88]

RULES OF AIR AND AIR TRAFFIC CONTROL

PART I – GENERAL

1. Misuse of signals and markings

(1) A signal of marking to which a meaning is given by these rules, or which is required by these rules to be used in circumstances or for a purpose therein specified, shall not be used except with that meaning, or for that purpose.

(2) A person in an aircraft, on an aerodrome or at any place at which an aircraft is taking off or landing, shall not make any signal which may be confused with a signal specified in this Schedule, and, except with lawful authority, shall not make any signal which he knows or ought reasonably to know to be a signal in use for signalling to or from any aircraft belonging to the Government of Mauritius.

2. Hazardous conditions

The commander of an aircraft shall, on meeting with hazardous conditions in the course of a flight, or as soon as possible thereafter, send to the appropriate air traffic control unit, by the quickest

means available, information containing such particulars of the hazardous conditions as may be pertinent to the safety of other aircraft.

3. Low flying

- (1) Subject to subparagraphs (3), (4), (5) and (6) –
 - (a) an aircraft, other than a helicopter, shall not fly over a congested area of a city, town or settlement below –
 - (i) such height as would enable the aircraft to alight clear of the area and without danger to persons or property on the surface, in the event of failure of a power unit;
 - (ii) a height of 1,000 feet above the highest fixed object within 600 metres of the aircraft, whichever is the higher;
 - (b) a helicopter shall fly below such height as would enable it to alight without danger to any person or property on the surface, in the event of failure of a power unit;
 - (c) except with the permission in writing of the Authority, no helicopter shall fly over a congested area of a city, town or settlement below a height of 1,000 feet above the highest fixed object within 600 metres of the helicopter;
 - (d) no aircraft shall fly –
 - (i) over, or within 3,000 feet of, an assembly in open air of more than 1,000 persons assembled for the purpose of witnessing or participating in an organised event, except with the permission in writing of the Authority and with the consent in writing of the organisers of the event; or
 - (ii) below such height as would enable it to alight clear of the assembly in the event of the failure of a power unit.
 - (e) an aircraft shall not fly at a height less than 500 feet above the ground or water.
- (2) In any proceeding for an offence under subparagraph (1), it shall be a sufficient defence for the person charged to prove that the flight of the aircraft over, or within 3,000 feet of, the assembly was made at a reasonable height and for a reason not connected with the assembly or with the event which was the occasion for the assembly.
- (3) Subparagraph (1)(a)(ii) and (c) shall not apply to an aircraft flying –
 - (a) on a route notified for the purposes of this rule; or
 - (b) on a special VFR flight in accordance with instructions given by the appropriate air traffic control unit.
- (4) Subparagraph (1)(d) and (e) shall not apply to –
 - (a) an aircraft in the service of the Government of Mauritius; or
 - (b) the flight of an aircraft over or within 3,000 feet of an assembly of persons gathered for the purpose of witnessing a flying display, if the aircraft is taking part in the display or is engaged on a flight arranged by, or made with the consent in writing of, the Authority.
- (5) Subparagraph (1)(e) shall not apply to –
 - (a) an aircraft while it is landing or taking off in accordance with normal aviation practice;
 - (b) a glider while it is hill-soaring; or
 - (c) an aircraft while it is flying in accordance with regulation 62(3)(b)(vi) or with the terms of an aerial application certificate granted under regulation 63.
- (6) Nothing in this rule shall prohibit an aircraft from flying –
 - (a) in such a manner as is necessary for the purpose of saving life; or
 - (b) in accordance with normal aviation practice, for the purpose of taking off from, landing or practising approaches to landing or checking navigational aids or procedures at an aerodrome.

(7) For the purpose of subparagraph 6(b), the practising of approaches to landing shall be confined to the airspace customarily used by aircraft when landing or taking off in accordance with normal aviation practice at the aerodrome concerned.

(8) This paragraph shall not apply to a captive balloon or kite.

4. Simulated instrument flight

Where an aircraft is flown in simulated instrument flight conditions –

- (a) it shall be fitted with dual controls, which are functioning properly;
- (b) in addition to the pilot flying the aircraft, a safety pilot, shall be carried in the second control seat for the purpose of rendering any assistance that the pilot may require; and
- (c) if the safety pilot's field of vision both forward and to every side of the aircraft is not adequate, a third person, who shall be a competent observer shall occupy a position in the aircraft from which he can –
 - (i) make good the deficiencies in the field of vision of the safety pilot; and
 - (ii) readily communicate with the safety pilot.

5. Practice instrument approaches

Within Mauritius, an aircraft shall not carry out instrument approach practice when flying in visual meteorological conditions unless –

- (a) the appropriate air traffic control unit has previously been informed that the flight is to be made for the purpose of instrument approach practice; and
- (b) in the case of a flight carried out otherwise than in simulated instrument flight conditions, a competent observer is carried in such a position in the aircraft that he has an adequate field of vision and can readily communicate with the pilot flying the aircraft.

PART II – LIGHTS AND OTHER SIGNALS

1. General

(1) For the purpose of this Part, the horizontal plane of a light shown in an aircraft means the plane which would be the horizontal plane passing through the source of that light, if the aircraft were in level flight.

(2) Where, by reason of the physical construction of an aircraft, it is necessary to fit more than one lamp in order to show a light required by this part, the lamps shall be so fitted and constructed that, so far as is reasonably practical, not more than one such lamp is visible from any one point outside the aircraft.

(3) Where a light is required to show through specified angles in the horizontal plane, the lamps giving such light shall be so constructed and fitted that the light is visible from any point in any vertical plane within those angles throughout angles of 90 degrees above and below the horizontal plane, but, so far as is reasonably practicable, through no greater angle, in the horizontal or vertical plane.

(4) Where a light is required to show in all directions, the lamps giving such light shall be so constructed and fitted that, so far as is reasonably practicable, the light is visible from any point in the horizontal plane and on any vertical plane passing through the source of that light.

2. Display of lights by aircraft

(1) An aircraft shall, by night, display such of the lights specified in paragraphs 4 to 8 as may be appropriate to the circumstances of the case, and shall not display any other light which might obscure or otherwise impair the visibility of, or be mistaken for, one of those lights.

(2) By day, an aircraft fitted with an anti-collision light shall display such a light in flight.

(3) A flying machine on a land aerodrome in Mauritius at which aircraft normally land or take off at night shall, unless it is stationary on the apron or a part of the aerodrome provided for the maintenance of aircraft, display by night the lights which it would be required to display if it were flying, or the lights specified in paragraph 4(2)(a) or (c).

(4) Notwithstanding this paragraph, the commander of an aircraft may switch off or reduce the intensity of any flashing light fitted to the aircraft if such a light does or is likely to –

- (a) adversely affect the performance of the duties of any member of the flight crew; or

- (b) subject an outside observer to unreasonable dazzle.

3. Failure of navigation lights

(1) In Mauritius, in the event of the failure of any light which is required by these rules to be displayed at night, if the light cannot be immediately repaired or replaced, the aircraft shall not depart from the aerodrome and if in flight, shall land as soon as in the opinion of the commander of the aircraft it can safely do so, unless authorised by the appropriate air traffic control unit to continue its flight.

(2) In Mauritius, in the event of a failure of an anti-collision light when flying by day, an aircraft may continue to fly by day, provided that the light is repaired at the earliest practicable opportunity.

4. Flying machines

- (1) A flying machine, when flying at night, shall display –
 - (a) in the case of a flying machine registered in Mauritius and having a maximum total authorised mass –
 - (i) exceeding 5,700 kilogrammes, the system of lights specified in subparagraph (2)(b);
 - (ii) of not more than 5,700 kilogrammes, any one of the systems of lights specified in subparagraph (2)(a), (b) or (d)(i); and
 - (b) in the case of any other flying machine, one of the systems of lights specified in subparagraph (2).
- (2) The system of lights referred to in subparagraph (1) shall be –
 - (a) steady lights as follows –
 - (i) a green light of at least 5 candela showing to the starboard side through an angle of 110 degrees from dead ahead in the horizontal plane;
 - (ii) a red light of at least 5 candela showing to the port side through an angle of 110 degrees from dead ahead in the horizontal plane; and
 - (iii) a white light of at least 3 candela showing through angles of 70 degrees from dead astern to each side in the horizontal plane;
 - (b) the lights specified in sub subparagraph (a) and an anti-collision light;
 - (c) the lights specified in sub subparagraph (a), but all being flashing lights flashing together;
 - (d) the lights specified in sub subparagraph (a), but all being flashing lights flashing together in alternation with one or both of the following –
 - (i) a flashing white light of at least 20 candela showing in all directions;
 - (ii) a flashing red light of at least 20 candela showing through angles of 70 degrees from dead astern to each side in the horizontal plane.

(3) Where the lamp showing the red or the green light specified in subparagraph (2)(a) is fitted more than 2 metres from the wing tip, a lamp may, notwithstanding paragraph 2(1), be fitted at the wing tip to indicate its position showing a steady light of the same colour through the same angle.

5. Gliders

A glider, while flying at night, shall display a steady red light of at least 5 candelas, showing in all directions, or lights in accordance with paragraphs 9(2) and (3).

6. Free balloons

A free balloon while flying at night shall display a steady red light, of at least 5 candela showing in all directions, suspended not less than 5 metres and not more than 10 metres below the basket, or if there is no basket, below the lowest part of the balloon.

7. Captive balloons and kites

(1) A captive balloon or kite while flying at night at a height exceeding 60 metres above the surface shall display –

- (a) a group of 2 steady lights consisting of a white light placed 4 metres above a red light, both being of at least 5 candela and showing in all directions, the white light being placed not less than 5 metres and not more than 10 metres below the basket, or if there is no basket, below the lowest part of the balloon or kite;
- (b) on the mooring cable, at intervals of not more than 300 metres measured from the group of lights referred to in sub subparagraph (a), groups of 2 lights of the colour and power and in the relative positions specified in that subparagraph, and, if the lowest group of lights is obscured by clouds, an additional group below the cloud base; and
- (c) on the surface, a group of 3 flashing lights arranged in a horizontal plane at the apexes of an approximately equilateral triangle, every side of which measures at least 25 metres, and –
 - (i) one side of the triangle shall be approximately at right angles to the horizontal projection of the cable and shall be delimited by 2 red lights;
 - (ii) the other 2 sides shall be so arranged that the triangle encloses the object on the surface to which the balloon or kite is moored and their intersection shall be marked by a green light.

(2) A captive balloon, while flying by day at a height exceeding 60 metres above the surface, shall have attached to its mooring cable at intervals of not more than 200 metres measured from the basket, or, if there is no basket, from the lowest part of the balloon, tubular streamers not less than 40 centimetres in diameter and 2 metres in length, and marked with alternate bands of red and white 50 centimetres wide.

(3) A kite flown in the circumstances referred to in subparagraph (2) shall have attached to its mooring cable –

- (a) tubular streamers as specified in subparagraph (2); or
- (b) at intervals of not more than 100 metres measured from the lowest part of the kite, streamers of not less than 80 centimetres long and 30 centimetres wide at their widest point and marked with alternate bands of red and white 10 centimetres wide.

8. Airships

(1) Subject to subparagraph (2), an airship while flying at night, shall display the following steady lights –

- (a) a white light of at least 5 candelas showing through angles of 110 degrees dead ahead to each side in the horizontal plane;
- (b) a green light of at least 5 candelas showing to the starboard side through an angle of 110 degrees from dead ahead in the horizontal plane;
- (c) a red light of at least 5 candelas showing to the port side through an angle of 110 degrees from dead ahead in the horizontal plane; and
- (d) a white light of at least 5 candelas showing through angles of 70 degrees from dead ahead to each side in the horizontal plane.

(2) Subject to subparagraph (3), an airship, while flying at night, shall display if it is not under command or has voluntarily stopped its engines or is being towed, the following steady lights –

- (a) the white lights referred to in subparagraph (1)(a) and (d);
- (b) 2 red lights, each of at least 5 candelas and showing in all directions suspended below the control car so that one is at least 4 metres above the other and at least 8 metres below the control car; and
- (c) if the airship is making way, the green and red lights referred to in subparagraphs (1)(b) and (c).

(3) An airship, while picking up its moorings, notwithstanding that it is not under command, shall display only the lights specified in subparagraph (1).

(4) An airship, while moored within Mauritius by night, shall display –

- (a) when moored to a mooring mast, at or near the rear, a white light of at least 5 candelas showing in all directions;
- (b) when moored otherwise than to a mooring mast –
 - (i) a white light of at least 5 candelas showing through angles of 110 degrees from dead ahead to each side in the horizontal plane; and
 - (ii) a white light of at least 5 candelas showing through angles of 70 degrees from dead astern to each side in the horizontal plane.

(5) An airship, while flying by day, if it is not under command or has voluntarily stopped its engines or is being towed, shall display 2 black balls suspended below the control car so that one is at least 4 metres above the other and at least 8 metres below the control car.

- (6) For the purpose of this rule, and airship shall –
 - (a) not be under command when it is unable to execute a manoeuvre, which it may be required to execute by or under this Schedule;
 - (b) be making way when it is not moored and is in motion relative to the air.

PART III – GENERAL FLIGHT RULES

1. Weather reports and forecasts

(1) Immediately before an aircraft flies, the commander of the aircraft shall examine the current reports and forecasts of the weather conditions on the proposed flight path, being reports and forecasts which it is reasonably practicable for him to obtain, in order to determine whether instrument meteorological conditions prevail or are likely to prevail during any part of the flight.

(2) An aircraft which is unable to communicate by radio with an air traffic control unit at the aerodrome of destination shall not begin a flight to an aerodrome within a control zone if the information which it is reasonably practicable for the commander of the aircraft to obtain indicates that it will arrive at that aerodrome when the ground visibility is less than 10 kilometres or the cloud ceiling is less than 1,500 feet, unless the commander of the aircraft has obtained from an air traffic control unit at that aerodrome permission to enter the aerodrome traffic zone.

2. Rules for avoiding aerial collisions

(1) General

(a) Notwithstanding that the flight is being made with air traffic control clearance, it shall remain the duty of the commander of an aircraft to take all possible measures to ensure that his aircraft does not collide with any other aircraft.

(b) No aircraft shall be flown in such proximity to any other aircraft as to create a danger of collision.

(c) No aircraft shall be flown in formation except by pre-arrangement among the pilots in command of the aircraft taking part in the flight and, for formation flight in controlled airspace, with the written permission of the Authority.

(d) An aircraft which is obliged by or under this Schedule to give way to another aircraft shall avoid passing over or under the other aircraft, or crossing ahead of it, unless passing well clear of it.

(e) An aircraft, which has the right of way under this paragraph, shall maintain its course and speed.

(f) For the purpose of this paragraph, a glider and a flying machine, which is towing it, shall be considered to be a single aircraft under the command of the commander of the towing flying machine.

(2) Converging

(a) Subject to subparagraphs (3) and (4), an aircraft in the air shall give way to other converging aircraft as follows –

- (i) a flying machine shall give way to an airship, glider or balloon;

- (ii) an airship shall give way to a glider or balloon;
- (iii) a glider shall give way to a balloon.

(b) Subject to sub subparagraphs (a) and (c), when 2 aircraft are converging in the air at approximately the same altitude, the aircraft, which has the other on its right, shall give way.

(c) A mechanically driven aircraft shall give way to an aircraft which is towing another aircraft or object.

(3) Approaching head-on

Where 2 aircraft are approaching head-on, or approximately so in the air and there is danger of collision, each shall alter its course to the right.

(4) Overtaking

(a) Subject to sub subparagraph (b), an aircraft which is being overtaken in the air shall have the right of way and the overtaking aircraft, whether climbing, descending or in horizontal flight, shall keep out of the way of the other aircraft by altering its course to the right, and shall not cease to keep out of the way of the other aircraft until the other aircraft has been passed and is clear, notwithstanding any change in the relative positions of the 2 aircraft.

(b) A glider overtaking another glider in Mauritius may alter its course to the right or to the left.

(5) Landing

An aircraft, while landing or on final approach to land, shall have the right of way over any other aircraft in light or on the ground or water.

(6) Two or more aircraft landing

(a) Subject to sub subparagraphs (b) and (c), in the case of 2 or more flying machines or gliders approaching any place for the purpose of landing, the aircraft at the lower altitude shall have the right of way, but it shall not cut in front of another aircraft which is on final approach to land or overtake that aircraft.

(b) Where an air traffic control unit has communicated to any aircraft an order of priority for landing, the aircraft shall approach to land in that order.

(c) Where the commander of an aircraft is aware that another aircraft is making an emergency landing, he shall give way to that other aircraft and, at night, notwithstanding that he may have received permission to land, shall not attempt to land until he has received further permission to do so.

(7) Flight in the vicinity of an aerodrome

Without prejudice to paragraphs 8 and 9 of Part VI, a flying machine, glider or airship while flying in the vicinity of what the commander of the aircraft knows or ought to reasonably know to be an aerodrome, or moving on an aerodrome, shall unless, in the case of an aerodrome having an air traffic control unit, that unit otherwise authorises –

- (a) conform to the pattern of traffic formed by other aircraft intending to land at that aerodrome, or keep clear of the airspace in which the pattern is formed; and
- (b) make all turns to the left unless ground signals otherwise indicate.

(8) Landing and take-off

(a) A flying machine, glider or airship shall take-off and land in the direction indicated by the ground signals or, if no such signal is displayed, into the wind, unless good aviation practice demands otherwise.

(b) No flying machine or glider shall land on a runway at an aerodrome if the runway is not clear of other aircraft unless, in the case of an aerodrome having an air traffic control unit, that unit authorises otherwise.

- (c) Where take-offs and landings are not confined to a runway –

- (i) a flying machine or glider, when landing, shall leave clear on its left any aircraft which has landed or is already landing or about to take off; if such a flying machine or glider is about to turn it shall turn to the left after the commander of the aircraft has satisfied himself that such action will not interfere with other traffic movements; and
- (ii) a flying machine about to take off shall take up position and manoeuvre in such a way as to leave clear on its left any aircraft which has already taken off or is about to take off.

(d) A flying machine, after landing, shall move clear of the landing area as soon as it is possible to do so unless, in the case of an aerodrome having an air traffic control unit, that unit authorises otherwise.

3. Aerobatic manoeuvres

No aircraft shall carry out any aerobatic manoeuvre –

- (a) over the congested area of any city, town or settlement; or
- (b) within controlled airspace except with the consent of the appropriate air traffic control unit.

4. Right-hand traffic rule

(1) An aircraft which is flying within Mauritius in sight of the ground and following a road, canal or coastline, or any other line of landmarks, shall keep such line of landmarks on its left.

(2) Subparagraph (1) shall not apply to an aircraft flying within controlled airspace in accordance with instructions given by the appropriate air traffic control unit.

5. Notification of arrival and departure

(1) The commander of an aircraft entering or leaving Mauritius on any flight for which a flight plan has been submitted shall take all reasonable steps to ensure upon landing that notice of the arrival of the aircraft is given to the aerodrome of departure.

(2) The commander of an aircraft who has caused notice of its intended arrival at any aerodrome shall ensure that the air traffic control unit or other authority at that aerodrome is informed, as soon as reasonably practicable, of any change of intended destination and any estimated delay in arrival of 45 minutes or more.

(3) The commander of an aircraft arriving at, or departing from an aerodrome in departure, as the case may be, that notice of that event is given to the person in charge of the aerodrome, or to the air traffic control unit or aerodrome flight information unit at the aerodrome.

6. Flight in Class A airspace

(1) In relation to flights in Visual Meteorological Conditions in Class A airspace, the commander of an aircraft shall comply with paragraphs 4 and 5 of Part V as if the flights were IFR flights, but shall not elect to continue the flight in compliance with the Visual Flight Rules for the purposes of paragraph 4(4).

(2) Subparagraph (1) shall not apply to the commander of a glider which is flying in Class A airspace which is notified for the purpose of this paragraph if the glider is flown in accordance with conditions such as may also be notified for the purpose of this subparagraph in respect of that airspace.

7. Choice of VFR or IFR

(1) Subject to subparagraph (2) and paragraph 6 of this Part, an aircraft shall always be flown in accordance with the Visual Flight Rules or the Instrument Flight Rules.

(2) An aircraft flying over Mauritius –

(a) at night –

- (i) outside controlled airspace, shall be flown in accordance with the Instrument Flight Rules; or
- (ii) inside controlled airspace, shall be flown in accordance with the Instrument Flight Rules or paragraph 2 of Part IV;

- (b) above flight level 200, shall be flown in accordance with the Instrument Flight Rules;
- (c) at transonic or supersonic speeds, shall be flown in accordance with the Instrument Flight Rules.

8. Speed limitation

(1) Subject to subparagraph (3), no aircraft shall fly below flight level 100 at a speed which, according to its air speed indicator, is more than 250 knots unless it is flying in accordance with the terms of a written permission of the Authority.

(2) The Authority may, subject to such conditions as it may determine and generally or in respect of any aircraft or class of aircraft, grant permission for the purpose of this paragraph.

(3) Subparagraph (1) shall not apply to –

- (a) flights in Class airspace;
- (b) VFR flights or IFR flights in Class B airspace;
- (c) IFR flights in Class C airspace;
- (d) VFR flights in Class C airspace, or VFR flights or IFR flights in Class D airspace when authorised by the appropriate air traffic control unit;
- (e) the flight of an aircraft taking part in an exhibition of flying for which a permission under regulation 75 is required, if the flight is made in accordance with the terms of a permission granted to the organiser of the exhibition of flying under regulation 75, and in accordance with the conditions of a display authorisation granted to the pilot under regulation 75; or
- (f) the flight of an aircraft flying in accordance with the 'A Conditions' or the 'B Conditions' set out in the First Schedule.

PART IV – VISUAL FLIGHT RULES

1. Visual Flight Rules and reported visibility

(1) In relation to flights within controlled airspace, paragraphs 2 and 4 of this Part shall constitute the Visual Flight Rules.

(2) In relation to flights outside controlled airspace, paragraph 21B shall constitute the Visual Flight Rules.

(3) For the purpose of an aeroplane taking off from or approaching to land at an aerodrome within Class B, C or D airspace, the visibility, if any, communicated to the commander of an aeroplane by the appropriate air traffic control unit shall be taken to be the flight visibility for the time being.

2. Flights within controlled airspace

(1) Within Class B airspace –

- (a) an aircraft flying within Class B airspace at or above flight level 100 shall remain clear of cloud and in a flight visibility of at least 8 kilometres;
- (b) an aircraft flying within Class B airspace below flight level 100 shall remain clear of cloud and in a flight visibility of at least 5 kilometres.

(2) Within Class C, Class D or Class E airspace –

- (a) an aircraft flying at or above flight level 100 shall remain at least 1,500 metres horizontally and 1,000 feet vertically away from cloud and in a flight visibility of at least 8 kilometres;
- (b) subject to sub subparagraph (c), an aircraft flying below flight level 100 shall remain at least 1,500 metres horizontally and 1,000 feet vertically away from cloud and in a flight visibility of at least 5 kilometres;
- (c) sub subparagraph (b) shall be deemed to be complied with if –
 - (i) the aircraft is not a helicopter and is flying at or below 3,000 feet above mean sea level at a speed which, according to its airspeed indicator, is 140 knots or less and it remains clear of cloud, in sight of the surface and in a flight visibility of at least 5

kilometres; or

- (ii) the aircraft is a helicopter flying at or below 3,000 feet above mean sea level and it remains clear of cloud and in sight of the surface.

3. Flight outside controlled airspace

(1) An aircraft flying outside controlled airspace at or above flight level 100 shall remain not less than 1,500 metres horizontally and 1,000 feet vertically away from cloud and in a flight visibility of not less than 8 kilometres.

(2) (a) Subject to sub subparagraph (b), an aircraft flying outside controlled airspace below flight level 100 shall remain not less than 1,500 metres horizontally and 1,000 feet vertically away from cloud and in a flight visibility of not less than 5 kilometres.

(b) Sub subparagraph (a) shall be deemed to be complied with if –

- (i) the aircraft is flying at or below 3,000 feet above mean sea level and remains clear of cloud and in sight of the surface and in a flight visibility of not less than 5 kilometres;
- (ii) the aircraft, other than a helicopter, is flying at or below 3,000 feet above mean sea level at a speed which, according to its air speed indicator, is 140 knots or less and remains clear of cloud and in sight of the surface and in flight visibility of not less than 1,500 metres; or
- (iii) the aircraft is a helicopter and is flying at or below 3,000 feet above mean sea level flying at a speed, which having regard to the visibility is reasonable, and remains clear of cloud and in sight of the surface.

4. VFR flight plan and air traffic control clearance

(1) Unless otherwise authorised by the appropriate air traffic control unit, before an aircraft flies within Class B, Class C or Class D airspace, the commander of the aircraft shall cause a flight plan to be communicated to the appropriate air traffic control unit and shall obtain an air traffic control clearance to fly within the said airspace.

(2) The flight plan shall contain such particulars of the flight as may be necessary to enable the air traffic control unit to issue a clearance and for search and rescue purposes.

(3) Any flight plan for a flight within Mauritius reduced vertical separation minimum airspace, when promulgated, shall also state whether or not the aircraft is equipped with height keeping systems as required by regulation 54 or 55, as the case may be.

(4) Whilst flying within the said airspace, the commander of the aircraft shall –

- (a) cause a continuous watch to be maintained on the notified radio frequency appropriate to the circumstances; and
- (b) comply with any instruction, which the appropriate air traffic control unit may give in a particular case.

(5) Subparagraphs (1), (2) and (3) shall not apply in respect of –

- (a) any glider flying or intending to fly in Class B airspace notified for the purpose of this subparagraph;
- (b) any glider flying during the day in controlled airspace notified for the purpose of this subparagraph which remains not less than 1,500 metres horizontally and 1,000 feet vertically away from cloud and in a flight visibility of not less than 8 kilometres; or
- (c) any mechanically driven aircraft without radio equipment flying during the day in controlled airspace notified for the purpose of this subparagraph which remains not less than 1,500 metres horizontally and 1,000 feet vertically away from cloud and in a flight visibility of not less than 5 kilometres the commander of which has previously obtained the permission of the appropriate air traffic control unit to fly within the said airspace.

PART V – INSTRUMENT FLIGHT RULES

1. Instrument Flight Rules

(1) In relation to flights within controlled airspace, paragraphs 2, 4 and 5 of this Part shall constitute the Instrument Flight Rules.

(2) In relation to flights outside controlled airspace, paragraphs 2 and 4 of this Part shall constitute the Instrument Flight Rules.

2. Minimum height

Without prejudice to paragraph 3, an aircraft shall not fly at a height of less than 1,000 feet above the highest obstacle within a distance of 8 kilometres of the aircraft unless –

- (a) it is necessary for the aircraft to do so in order to take-off or land;
- (b) the aircraft is flying on a route notified for the purposes of this paragraph;
- (c) the aircraft has been otherwise authorised by the competent authority; or
- (d) the aircraft is flying at an altitude not exceeding 3,000 feet above mean sea level and remains clear of cloud and in sight of the surface.

3. Semi-circular rule

(1) In order to comply with this Part, an aircraft shall, when in level flight above 3,000 feet above mean sea level or above the appropriate transition altitude, whichever is the higher, be flown at a flight level appropriate to its magnetic track, in accordance with the appropriate Table set out in subparagraph (4) and the level of flight shall be measured by an altimeter set –

- (a) in the case of flight over Mauritius, to a pressure setting of 1013.2 hPa; or
- (b) in the case of any other flight, according to the system published by the competent authority in relation to the area over which the aircraft is flying.

(2) An aircraft may be flown at a level other than the level required by subparagraph (1) if it is flying in accordance with –

- (a) instructions given by an air traffic control unit;
- (b) notified en route holding patterns; or
- (c) holding procedures notified in relation to an aerodrome.

(3) In this paragraph –

“transition altitude” means the altitude so notified in relation to a flight over any area that may be specified.

TABLE I

Flights at levels below flight levels 290	
Magnetic track	Cruising flight level
Less than 180 degrees	Flight levels 30, 50, 70 etc. (that is, odd multiples of 10)
180 degrees or more but less than 360 degrees	Flight levels 40, 60, 80 etc. (that is, even multiples of 10)

TABLE II

Flights at levels below flight levels 290	
Magnetic track	Cruising flight level

Less than 180 degrees	Flight levels 290, 330, 370 etc. (that is, in multiples of 40 above level 290)
180 degrees or more but less than 360 degrees	Flight levels 310, 350, 390 etc. (that is, in multiples of 40 above level 310)

4. Flight plans and air traffic control clearance

(1) In order to comply with the Instrument Flight Rules, before an aircraft takes off from a point within any controlled airspace or otherwise flies within any controlled airspace, the commander of the aircraft shall cause a flight plan to be communicated to the appropriate air traffic control unit and shall obtain an air traffic control clearance based on such flight plan.

(2) The flight plan shall contain such particulars of the intended flight as may be necessary to enable the air traffic control unit to issue an air traffic control clearance, and for search and rescue purposes.

(3) Any flight plan for a flight within Mauritius reduced vertical separation minimum airspace, when promulgated, shall also state whether or not the aircraft is equipped with height keeping systems as required by regulation 54 or 55, as the case may be.

(4) (a) Subject to sub subparagraph (b), the commander of the aircraft shall fly in conformity with –

- (i) the air traffic control clearance issued for the flight, as amended by any further instruction given by an air traffic control unit; and
- (ii) (A) the instrument departure procedures notified in relation to the aerodrome of departure unless he is otherwise authorised by the appropriate air traffic control unit; and
(B) the holding and instrument approach procedures notified in relation to the aerodrome of destination unless he is otherwise authorised by the appropriate air traffic control unit.

(b) The commander of the aircraft shall not be required to comply with sub subparagraph (a) if –

- (i) he is able to fly in uninterrupted Visual Meteorological Conditions for so long as he remains in controlled airspace; and
- (ii) he has informed the appropriate air traffic control unit of his intention to continue the flight in compliance with Visual Flight Rules and has requested that unit to cancel his flight plan.

(5) If, for the purpose of avoiding immediate danger, any departure from subparagraph (4) is made under regulations 88(2) and 89(3), the commander of the aircraft shall, as soon as reasonably practicable, inform the appropriate air traffic control unit of the deviation.

(6) The commander of the aircraft shall, after it has flown in controlled airspace, unless he has requested the appropriate air traffic control unit to cancel his flight plan, forthwith inform that unit when the aircraft lands within or leaves the controlled airspace.

5. Position reports

The commander of an aircraft in IFR flight who flies in or intends to enter controlled airspace shall report to the appropriate air traffic control unit the time, position and level of the aircraft at such reporting points or at such intervals of time as may be notified for this purpose or as may be directed by the appropriate air traffic control unit.

PART VI – AERODROME TRAFFIC RULES

1. Application of aerodrome traffic rules

Paragraphs 2 to 10 of this Part shall constitute the rules for regulating the aerodrome traffic, both

on ground and in the air, and the rules which shall apply to flying machines shall, as far as practicable, extend to all other aircraft.

2. Visual signals

(1) Subject to subparagraph (2), the commander of a flying machine on, or in the traffic zone of, an aerodrome shall observe such visual signals as may be displayed at, or directed to him from, the aerodrome by authority of the person in charge of the aerodrome and shall obey any instruction which may be given to him by means of those signals.

(2) The commander of a flying machine shall not be required to obey the marshalling signals referred to in paragraph 5 of Part VII if, in his opinion, it is inadvisable, in the interests of safety, to do so.

3. Movement of aircraft on aerodromes

An aircraft shall not taxi on the manoeuvring area of an aerodrome without the permission of –

- (a) the person in charge of the aerodrome; or
- (b) the appropriate air traffic control unit.

4. Access to and movement on manoeuvring area and other parts of any aerodrome used by aircraft

(1) No person or vehicle shall, except with the permission of the person in charge of an aerodrome, enter any part of an aerodrome –

- (a) provided for the use of aircraft; and
- (b) under the control of the person in charge of the aerodrome.

5. Right of way on ground

(1) This paragraph shall apply to –

- (a) flying machines; and
- (b) vehicles,

on any part of a land aerodrome provided for the use of aircraft and under the control of the person in charge of the aerodrome.

(2) Notwithstanding any air traffic control clearance, the commander of an aircraft shall take all possible measures to ensure that his aircraft does not collide with any other aircraft or with any vehicle.

(3) Flying machines and vehicles shall give way to aircraft which are taking off or landing.

(4) Vehicles and flying machines which are not taking off or landing, shall give way to vehicles towing aircraft.

(5) Vehicles which are not towing aircraft shall give way to aircraft.

(6) Subject to subparagraphs (3), (4) and (5) and to paragraph 8(5), in case of danger of collision between 2 flying machines –

- (a) when the 2 flying machines are approaching head-on or approximately so, each shall alter its course to the right;
- (b) when 2 flying machines are on converging courses, the one which has the other on its right shall give way to the other and shall avoid crossing ahead of the other unless passing well clear of it;
- (c) a flying machine which is being overtaken shall have the right of way, and the overtaking flying machine shall keep out of the way of the other flying machine by altering its course to the left until that other flying machine has been passed and is clear, notwithstanding any change in the relative positions of the 2 flying machines.

(7) Subject to subparagraph (4), a vehicle shall –

- (a) overtake another vehicle so that the other vehicle is on the left of the overtaking vehicle;
- (b) keep to the left when passing another vehicle which is approaching head-on or approximately so.

6. Dropping of articles

Tow ropes, banners or similar articles towed by aircraft shall not be dropped from aircraft except at an aerodrome and –

- (a) in accordance with arrangements made with the appropriate air traffic control unit or, if there is no such limit, with the person in charge of the aerodrome; or
- (b) in the area designated by the marking described in paragraph 4(2)(c)(vii) of Part VII and the ropes, banners or similar articles shall be dropped when the aircraft is flying in the direction appropriate for landing.

7. Fireworks display

No person shall launch a firework display within 5 kilometres of an aerodrome, except with the written permission of the Authority.

8. Aerodromes not having air traffic control units

(1) An aircraft shall not fly within a zone which the commander of the aircraft knows or ought reasonably to know to be the aerodrome traffic zone of an aerodrome where no traffic control unit is, for the time being, notified as being on watch, except for the purpose of taking off or landing at that aerodrome or observing the signals with a view to landing there, unless he has the permission of the person in charge of the aerodrome.

(2) An aircraft flying in a zone falling under subparagraph (1) for the purpose of observing the signals shall remain clear of cloud and at least 500 feet above the level of the aerodrome.

(3) An aircraft flying in a zone referred to in subparagraph (1) or moving on an aerodrome referred to in paragraph 1 shall –

- (a) conform to the pattern of traffic formed by other aircraft, or keep clear of the airspace in which the pattern is formed;
- (b) make all turns to the left unless ground signals otherwise indicate; and
- (c) take off and land in the direction indicated by the ground signals or, if no such signals are displayed, into the wind, unless good aviation practice demands otherwise.

(4) A flying machine or glider shall not land on a runway at an aerodrome referred to in subparagraph (1) unless the runway is clear of other aircraft.

(5) Where take-offs and landings are not confined to a runway –

- (a) a flying machine or glider, when landing, shall –
 - (i) leave clear on its left, any aircraft which has already landed, is landing or is about to take off;
 - (ii) if it is obliged to turn, turn to the left after the commander of the aircraft has satisfied himself that his action will not interfere with other traffic movements; and
- (b) a flying machine about to take off shall take up position and manoeuvre in such a way as to leave clear on its left any aircraft, which is taking off or is about to take off.

(6) A flying machine shall, after landing, move clear of the landing area in use as soon as it is possible to do so.

9. Aerodromes having air traffic control units

(1) An aircraft shall not fly within a zone which the commander of the aircraft knows or ought reasonably to know to be the aerodrome traffic zone of an aerodrome where an air traffic control unit is, for the time being, notified as being on watch, except for the purpose of observing any signal at that aerodrome with a view to landing there, unless he has the permission of the appropriate air traffic control unit.

(2) The commander of an aircraft flying in the aerodrome traffic unit of an aerodrome where an air traffic control unit is, for the time being, notified as being on watch or moving on such an aerodrome shall –

- (a) cause a continuous watch to be maintained on the appropriate radio frequency for air

traffic control communications at the aerodrome, or, if this is not possible, cause a watch to be kept for such instructions as may be issued by visual means;

- (b) not taxi on the apron or manoeuvring area or take-off or land anywhere in the zone except with the permission of the appropriate air traffic control unit;
- (c) comply with paragraphs 8(2), (3), (4), (5) and (6) as if the aerodrome did not have an air traffic control unit, unless he has the permission of the appropriate control unit, or has been instructed by that unit, to do otherwise.

(3) Without prejudice to paragraphs 5 of Part III and 4 of Part V, the commander of an aircraft shall, immediately on arrival at, or prior to departure from, an aerodrome within Mauritius having an air traffic control unit, ensure that such unit is informed of the flight which he has just made or which he is about to undertake.

10. Use of radio navigation aids

The commander of an aircraft shall not make use of any radio navigation aid provided in Mauritius without complying with such restrictions and procedures as may be notified in relation to that aid.

PART VII – SIGNALS AND MARKINGS

1. Distress, urgency and safety signals

(1) The following signals, given together or separately before the sending of a message, shall signify that the aircraft is threatened by grave and imminent danger and requests immediate assistance –

- (a) a signal sent by radiotelephony consisting of the spoken word “MAYDAY”;
- (b) a signal sent by visual means consisting of –
 - (i) the group SOS (... - - ...) in the Morse code;
 - (ii) a succession of pyrotechnic lights fires at short intervals, each showing a single red light;
 - (iii) a parachute flare showing a red light;
- (c) a signal made otherwise than by radiotelephony consisting of –
 - (i) the signal SOS (... - - ...);
 - (ii) a continuous sounding with any sound apparatus.

(2) The following signals, given together or separately, before the sending of a message, signify that the commander of the aircraft wishes to give notice of difficulties which compel him to land, but that he does not require immediate assistance –

- (a) a succession of white pyrotechnic lights;
- (b) the repeated switching on and off of the aircraft landing lights;
- (c) the repeated switching on and off of its navigation lights, in such a manner as to be clearly distinguishable from the flashing navigation lights specified in paragraph 4 of Part II.

(3) The following signals, given together or separately, indicate that the commander of the aircraft has an urgent message to transmit concerning the safety of a ship, aircraft, vehicle or other property or of a person on board or within sight of the aircraft from which the signal is given –

- (a) a signal sent by radiotelephony consisting of the spoken word “PAN”;
- (b) a signal sent by visual means consisting of the group XXX (-.. -)(-.. -.. - -.. -) in the Morse code.

2. Signals for use in event of interception

(1) (a) As interception of aircraft is potentially hazardous, it will be reported to only as a last resort. Ensuring adherence to flight plans and ATC procedures and the maintenance of a listening watch on the appropriate ATC frequency, make the possibility of interception highly improbable. If the identity of the aircraft is in doubt, all possible efforts shall be made to secure identification through the appropriate air traffic services unit.

- (b) An aircraft which is intercepted by another aircraft shall immediately –
- (i) follow the instructions given by the intercepting aircraft, interpreting and responding to visual signals as specified in subparagraph (2);
 - (ii) notify, if possible, the appropriate Air Traffic Services Unit;
 - (iii) attempt to establish radio communication with the intercepting aircraft or appropriate intercept control unit, by making a general call on the emergency frequency 121.5 MHz, giving the identity of the intercepted aircraft and the nature of the flight, and if no contact has been established and if practicable, repeating this call on the emergency frequency 243 MHz;
 - (iv) if equipped with SSR transponder, select Mode A, Code 7700 and mode C, unless otherwise instructed by the appropriate Air Traffic Unit.

(2) Signals initiated by intercepting aircraft and responses by intercepted aircraft

	Series Intercepting aircraft signals	Meaning	Intercepted aircraft response
1.	DAY – Rocking wings from a position in front and, normally, to the left of intercepted aircraft and, after acknowledgement, a slow level turn, normally to the left, on the desired heading	You have been intercepted Follow me	Aeroplanes DAY – Rocking wings following
	NIGHT – Same and, in addition flashing navigational lights at irregular intervals		NIGHT – Same and in addition flashing navigational lights at irregular intervals
	Note 1		HELICOPTERS –
	<p>Meteorological conditions or terrain may require the intercepting aircraft to take up a position in front and to the right of the intercepted aircraft and to make the subsequent turn to the right</p> <p>Note 2</p> <p>If the intercepted aircraft is not able to keep pace with the intercepting aircraft, the latter shall fly a series of racetrack patterns and to rock its wings every time it passes the intercepted aircraft</p>		<p>DAY or NIGHT – Rocking wings and flashing navigational lights at irregular intervals following</p> <p>Note – The above is in addition to the provisions of subparagraph (1) which shall be complied with in any case</p>
2.	DAY or NIGHT – An abrupt breakaway manoeuvre from the intercepted aircraft consisting of a climbing turn of 90 degrees or more without crossing the line of flight of the intercepted aircraft	You may proceed	<p>AEROPLANES – DAY or NIGHT – Rocking wings</p> <p>HELICOPTERS – DAY or NIGHT – Rocking wings</p>
3.	<p>DAY – Circling aerodrome, lowering landing gear and overflying runway in direction of landing or, if the intercepted aircraft is a helicopter, overflying the helicopter landing area</p> <p>NIGHT – Same and in addition, showing steady landing lights</p>	Land at this aerodrome	<p>AEROPLANES – DAY – Lowering landing gear, following the intercepting aircraft after overflying the runway in direction of landing. If considered safe, proceeding to land</p> <p>NIGHT – Same and, in addition, showing steady landing light (if carried)</p> <p>HELICOPTERS – DAY or NIGHT – Lowering landing gear, following the intercepting aircraft after overflying the runway in direction of landing. If considered safe, proceeding to land</p>

			the intercepting aircraft and proceed showing a steady landing light (if can
--	--	--	--

(3) Signals initiated by intercepted aircraft and responses by intercepting aircraft.

	INTERCEPTED Aircraft signals	Meaning	INTERCEPTING Aircraft Responses
1.	AEROPLANES DAY – Raising landing gear while passing over landing runway at a height of not less than 300m (1,000 ft) nor more than 600m (2,000 ft) above the aerodrome level and continuing to circle the aerodrome	Aerodrome you have designated is inadequate	DAY or NIGHT – If it is desired intercepted aircraft follow the instructions of the intercepting aircraft to an alternate aerodrome. If the intercepting aircraft raises its landing gear and uses the Series 1 signals prescribed for intercepting aircraft
	NIGHT – Flashing landing lights while passing over landing runway at a height of not less than 300m, (1,000 ft) nor more than 600m (2,000 ft) above the aerodrome. If unable to flash landing lights, flash any other lights available		If it is decided to release the intercepted aircraft; the intercepting aircraft uses the Series 2 signals prescribed for intercepting aircraft
2.	AEROPLANES – DAY or NIGHT – Regular switching on and off of all available lights but in such a manner as to be distinct from flashing lights	Cannot comply	DAY or NIGHT – Use Series 1 signals prescribed for intercepting aircraft
3.	AEROPLANES – DAY or NIGHT – Irregular flashing of all available lights HELICOPTERS – DAY or NIGHT – Irregular flashing of all available lights	In distress	DAY or NIGHT – Use Series 1 signals prescribed for intercepting aircraft

(4) The following phrases are to be used by the intercepting and intercepted aircraft if radio contact is established –

(i) by the intercepted aircraft

Phrase	Meaning	Phrase	Meaning
Call Sign	My Call sign is (...)	Descend	I require descent
Am lost	Position unknown	Wilco	Understood. Will comply
Mayday	I am in distress	Cannot	Unable to comply
Hijack	I have been hijacked		
Land (place name)	I request to land at (place name)	Repeat	Repeat your instructions

Note – The call sign required to be given is that used in radiotelephony communications with Air traffic services Units and corresponding to the aircraft identification in the flight plan.

(ii) by the intercepting aircraft

Phrase	Meaning	Phrase	Meaning
Call sign	What is your call sign	You land	Land at this aerodrome
Follow Descend	Follow me Descend for Landing	Proceed	You may proceed

Note 1 – If any instruction received by radio from any sources conflicts with those given by the intercepting aircraft by signals, the intercepted aircraft shall request immediate clarification while continuing to comply with the visual instructions given by the intercepting aircraft.

Note 2 – If any instruction received by radio from any sources conflicts with the instruction given by the intercepting aircraft by radio, the intercepted aircraft shall request immediate clarification while continuing to comply with the radio instructions given by the intercepting aircraft.

3. Visual signals used to warn an authorised aircraft flying in, or about to enter a restricted, prohibited or danger area

By day and by night, a series of projectiles discharged from the ground at intervals of 10 seconds, each showing, on bursting, green lights or stars, shall indicate to an authorised aircraft that it is flying in or about to enter a restricted, prohibited or danger area, and that the aircraft is to take such remedial action as may be necessary.

4. Aerodrome signals and markings

(1) Meaning of lights and pyrotechnic signals

(a) Instructions

Characteristic and colour of light beam or pyrotechnic	From an Aerodrome	
	To an aircraft in flight	To an aircraft or vehicle on the aerodrome
Continuous red light	Give way to other aircraft and continue circling	Stop
Red pyrotechnic light or red flare	Do not land, wait for permission	
Red flashes	Do not land, aerodrome not available for landing	Move clear of landing area
Green flashes	Return to aerodrome wait for permission to land	To an aircraft – you may move on the manoeuvring area and apron. To a vehicle – You may move on the manoeuvring area
Continuous green light	You may land	You may take off (not applicable to a vehicle)
Continuous green light or green flashes or green pyrotechnic light	-----	-----

Characteristic and colour of light beam or pyrotechnic	From an Aerodrome	
	To an aircraft in flight	To an aircraft or vehicle on the aerodrome
White flashes	Land at this aerodrome after receiving continuous green light, and then after receiving green flashes, proceed to the apron	Return to starting point on the aerodrome
White pyrotechnic light. Switching on and off the landing lights	–	–

(b) Acknowledgement by aircraft

(i) When in flight during the hours of daylight, by rocking the aircraft's wings. This signal shall not be expected on the base and final legs of the approach.

(ii) When in flight during the hours of darkness, by flashing on and off twice the aircraft's landing lights or, if not so equipped, by switching on and off twice its navigation lights.

(iii) When on the ground during the hours of daylight, by moving the aircraft's ailerons or rudder.

(iv) when on the ground during the hours of darkness, by flashing on and off twice the aircraft's landing lights or, if not so equipped, by switching on and off twice its navigation lights.

(2) Visual ground signals

(a) Signals in the signals area

(i) A white landing 'T', as illustrated in Figure 1 signifies that aeroplanes and gliders taking off or landing shall do so in a direction parallel with the shaft of the T and towards the cross arm, unless otherwise authorised by the appropriate air traffic control unit.

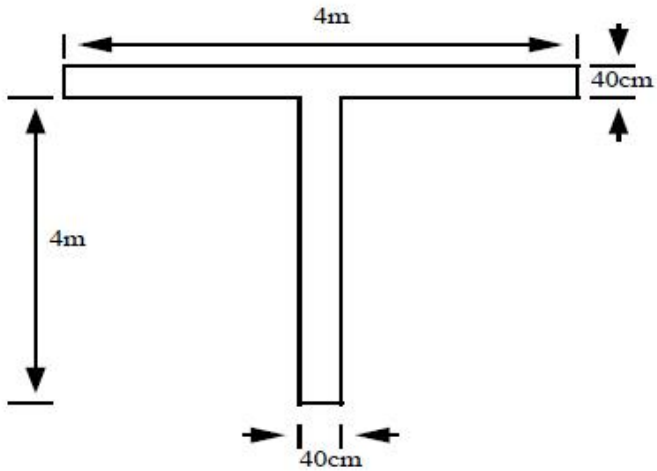
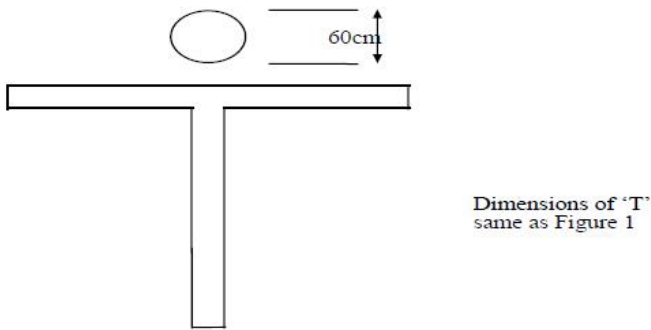

Fig. 1

Fig. 1

(ii) A white disc 60 centimetres in diameter displayed alongside the cross arm of the 'T' and in line with the shaft of the 'T', as illustrated in Figure 2 signifies that the direction of landing and take-off do not necessarily coincide.



Dimensions of 'T'
same as Figure 1

Fig. 2

Fig. 2

(iii) A white dumb-bell, as illustrated in Figure 3 signifies that movements of aeroplanes and gliders on the ground shall be confined to paved metallated or similar hard surfaces.

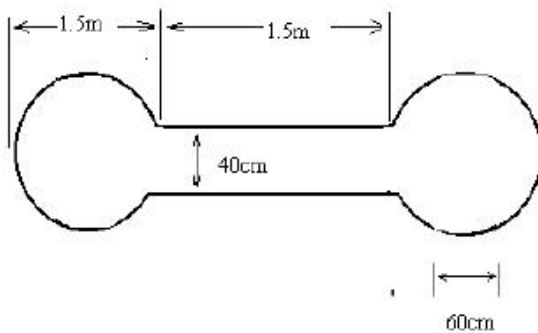

Fig. 3

Fig. 3

(iv) A white dumb-bell as described in sub sub subparagraph (iii) above but with a black strip 60 centimetres wide across each disc at right angles to the shaft of the dumb-bell, as illustrated in Figure 4 signifies that aeroplanes and gliders taking off or landing shall do so on a runway but that movement on the ground is not confined to paved, metallised or similar hard surfaces.

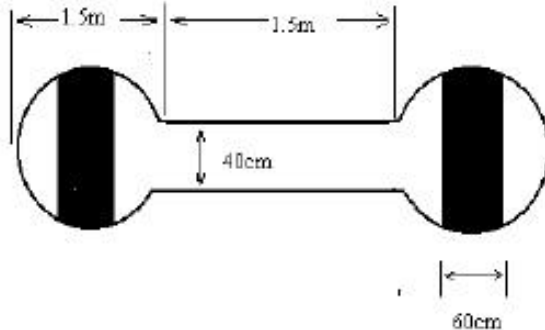

Fig. 4

(v) A red and yellow striped arrow, as illustrated in Figure 5, the shaft of which is at least one metre wide, placed along the whole or not less than a total of 11 metres of 2 adjacent sides of the signals area and pointing in a clockwise direction signifies that a right-hand circuit is in force.

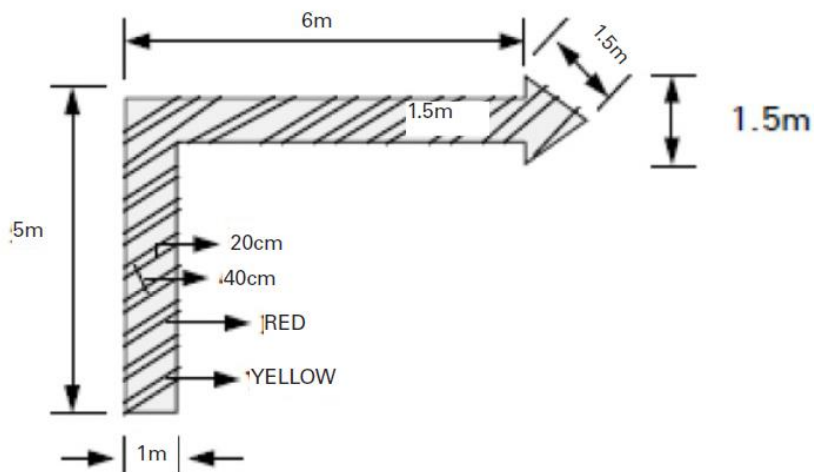

Fig. 5

(vi) A red panel of a length of 3 metres with a yellow strip along one diagonal at least 50 centimetres wide as illustrated in Figure 6 signifies that the state of the manoeuvring area is poor and pilots shall exercise special care when landing.

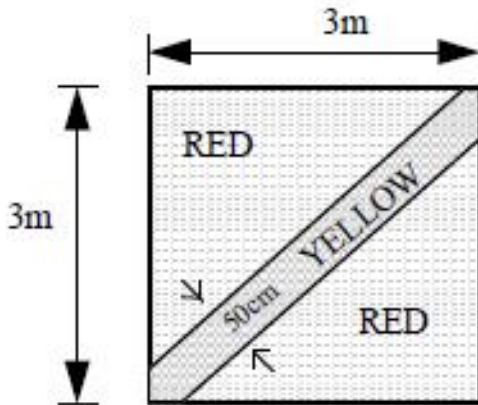

Fig. 6

(vii) A red panel 3 metres square with a yellow strip, at least 50 centimetres wide, along each diagonal, as illustrated in Figure 7 signifies that the aerodrome is unsafe for the movement of aircraft and that landing on the aerodrome is prohibited.

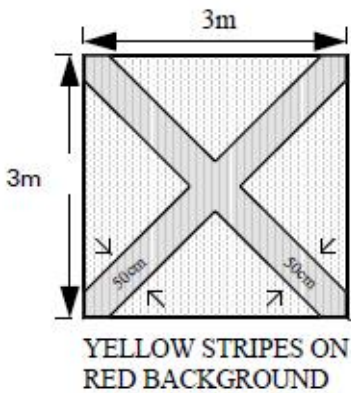

Fig. 7

(viii) A white letter 'H', as illustrated in this paragraph, signifies that helicopters shall take-off and land only within the area designated by the marking specified in paragraph 4(2)(c)(v).

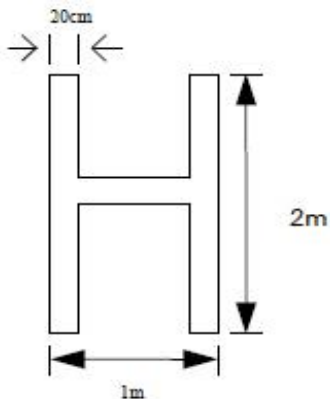

Fig. 8

(ix) A red letter 'L' displayed on the dumb-bell specified in paragraph 4(2)(c)(iii) and (iv), as illustrated in Figure 9, signifies that light aircraft are permitted to take-off and land on a runway or on the area designated by the marking specified in paragraph 4(2)(c)(vi).

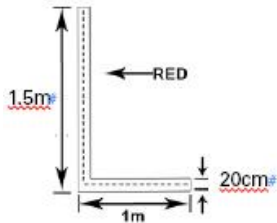

Fig. 9

(x) A white double cross, as illustrated in Figure 10, signifies that glider flying is in progress.

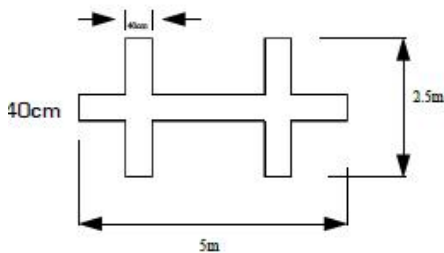

Fig. 10

(b) Markings for Paved Runways and Taxiways

(i) Two or more white crosses, as illustrated in Figure 11, displayed on a runway or taxiway, with the arms of the crosses at an angle of 45 degrees to the centre line of the runway, at intervals of not more than 300 metres signify that the section of the runway or taxiway marked by them is unfit for the movement of aircraft.

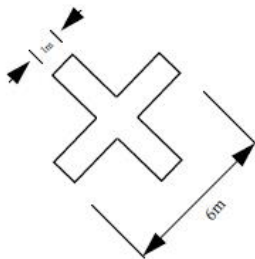

Fig. 11

(ii) A white broken line and a continuous line, as illustrated in Figure 12 signify a holding position beyond which no part of an aircraft or vehicle shall project in the direction of the runway without permission from an air traffic control unit.

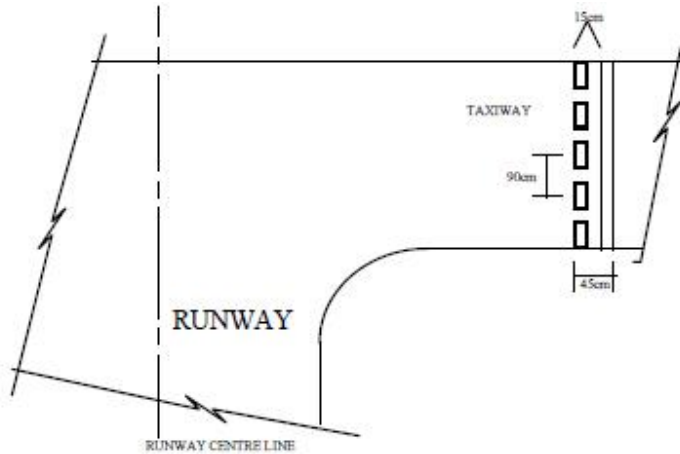

Fig. 12

(iii) Orange and white markers, as illustrated in Figure 13, spaced not more than 15 metres apart, signify the boundary of that part of a paved runway, taxiway or apron which is unfit for the movement of aircraft.

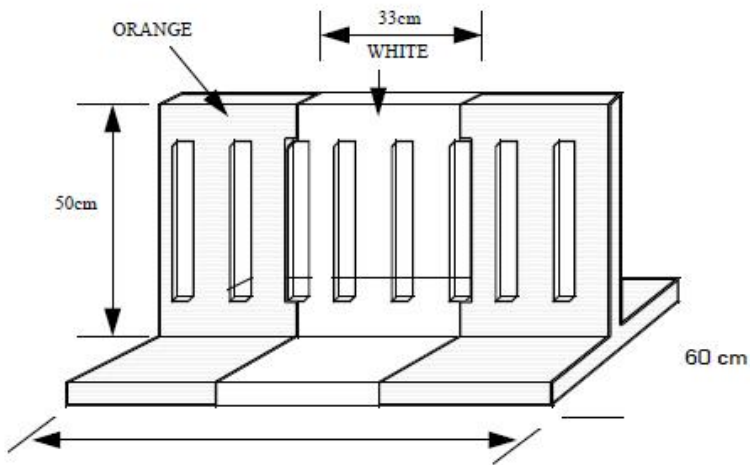

Fig. 13

(c) Markings on unpaved manoeuvring areas

(i) Markers with orange and white stripes of an equal width of not less than 50 centimetres, with an orange stripe at each end, as illustrated in Figure 14, alternating with flags not less than 60 centimetres square showing equal orange and white triangular areas, indicate the boundary of an area unfit for the movement of aircraft and one or more white crosses as specified in paragraph 4(2)(b)(i), indicate the said area. The distance between any 2 successive orange and white flags shall not exceed 90 metres.

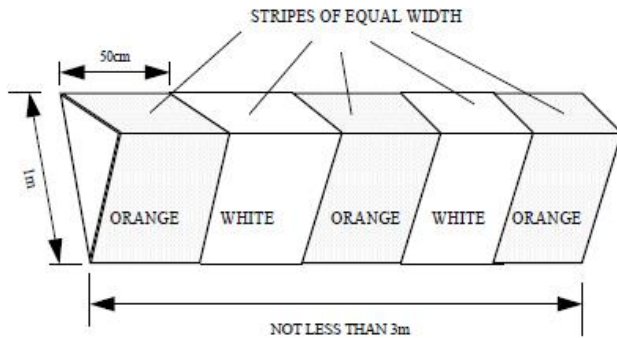

Fig. 14

(ii) Striped markers, as specified in sub sub subparagraph (i) , spaced not more than 45 metres apart, indicate the boundary of an aerodrome.

(iii) On structures, markers with orange and white vertical stripes, of an equal width not less than 50 centimetres, with orange stripe at each end, as illustrated in Figure 15, spaced not more than 45 metres apart indicate the boundary of an aerodrome. The pattern of the marker shall be visible from inside and outside the aerodrome and the marker shall be affixed not more than 15 centimetres from the top of the structure.

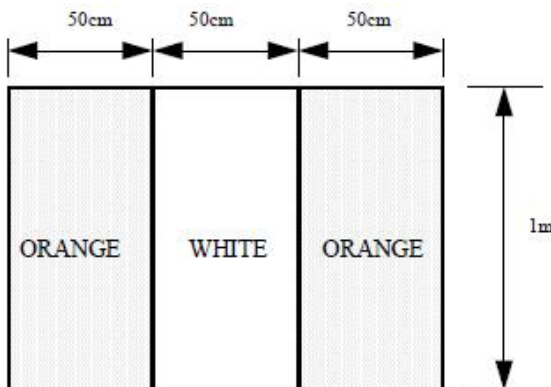

Fig. 15

(iv) White flat rectangular markers 3 metres long and 1 metre wide at intervals not exceeding 90 metres, flush with the surface of the unpaved runway or stop way, as the case may be, indicate the boundary of an unpaved runway or of a stop way.

(v) A white letter H, as illustrated in Figure 16, indicates an area, which shall be used only for the taking off and landing of helicopters.

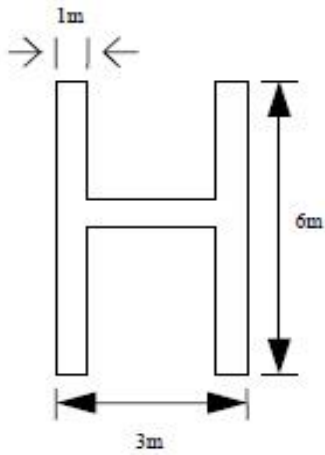
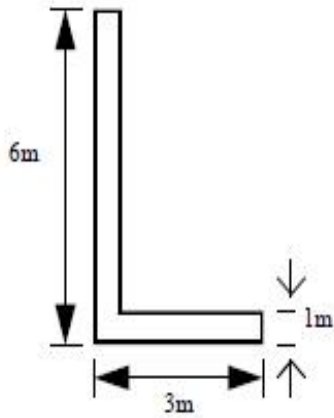

Fig. 16



(vi) A white letter 'L' as illustrated in Figure 17, indicates a part of the manoeuvring area, which shall be used for the taking off, and landing of light aircraft.

Fig. 17

(vii) A yellow cross with 2 arms 6 metres long by one metre wide at right angles indicates that tow rope and similar articles towed by aircraft shall only be dropped in the area in which the cross is placed.

(viii) A white double cross as illustrated in Figure 18 indicates an area, which shall be used only for the taking off and landing of gliders.

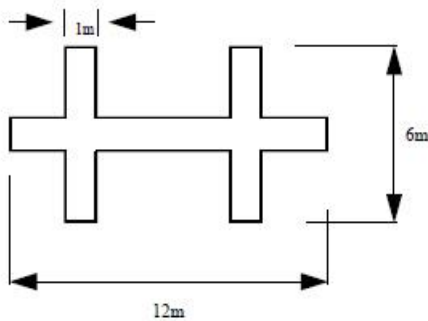

Fig. 18

(ix) A white landing T as specified in paragraph 4(2)(a)(i) placed at the left hand side of the runway when viewed from the direction of landing indicates the runway to be used, and at an aerodrome with no runway it indicates the direction for take-off and landing.

(d) Signals visible from the ground

(i) A black ball 60 centimetres in diameter suspended from a mast indicates that directions of take-off and landing are not necessarily the same.

(ii) A checkered flag or board, 1.2 metres by 90 centimetres containing 12 equal squares, 4 horizontally and 3 vertically, coloured red and yellow alternately, signifies that aircraft may move on the manoeuvring area and apron only in accordance with the permission of the air traffic control unit at the aerodrome.

(iii) Two red balls 60 centimetres in diameter, disposed vertically one above the other, 60 centimetres apart and suspended from a mast, signify that glider flying is in progress at the aerodrome.

(iv) Black Arabic numerals in two-figure groups and, where parallel runways are provided the letters or letter L (left), LC (left centre), C (centre), RC (right centre) and R (right), placed against a yellow background, indicate the direction for take-off or the runway in use.

(v) A black letter C against a yellow background, as illustrated in Figure 19 hereunder

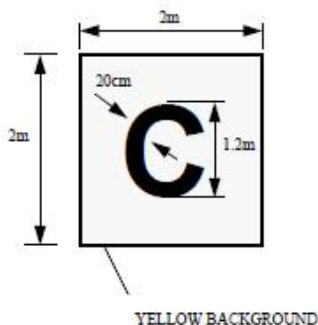

Fig. 19

indicates the position at which a pilot can report to the air traffic control unit or to the person in charge

of the aerodrome.

(vi) A rectangular green flag of not less than 60 centimetres square flown from a mast indicates that a right hand circuit is in force.

5. Marshalling signals

From a marshaller to an aircraft

Every signal for the guidance of aircraft manoeuvring on or off the ground, set out in the first column of the table hereunder shall, in Mauritius, have the meaning set forth in the second column of that table opposite the description of the signal.

Note 1 – The signals are designed for use by the signalman, with hands illuminated as necessary to facilitate observation by the pilot, and facing the aircraft in a position –

- (a) for fixed-wing aircraft, on the left side of aircraft, where best seen by the pilot; and
- (b) for helicopters, where the signalman may be best seen by the pilot.

Note 2 – The meaning of the signals remains the same if bats, illuminated wands or torch lights are held.

Note 3 – The aircraft engines are numbered, for the signalman facing the aircraft, from right to left (i.e. No. 1 engine being the port outer engine).

Note 4 – Signals marked with an asterisk (*) are designed for use to hovering helicopters.





Note 5 – References to wands may be also read to refer to daylight fluorescent coloured table-tennis bats or gloves (daytime only).





Note 6 – References to the signalman may also be read to refer to marshaller.





5.1.1 Prior to using the following signals, the signalman shall ascertain that the area within which an aircraft is to be guided is clear of objects which the aircraft, in complying with 3.4.1, might otherwise strike.





Note – The design of many aircraft is such that the path of the wing tips, engines and other extremities cannot always be monitored visually from the flight deck while the aircraft is being manoeuvred on the ground.





Signal		Description of signal
1.		<p>Wing walker/guide</p> <p>Raise right hand above head level with wand pointing up; move left hand wand pointing down toward body</p> <p>Note – This signal provides an indication by a person positioned at the aircraft wing tip, to the pilot/marshaller/push-back operator, that the aircraft movement on/off a parking position would be unobstructed</p>





2.		<p style="text-align: center;">Identify gate</p> <p>Raise fully extended arms straight above head with wands pointing up</p>
3.		<p style="text-align: center;">Proceed to next signalman or as directed by tower/ground control</p> <p>Point both arms upward; move and extend arms outward to sides of body and point with wands to direction of next signalman or taxi area</p>
4.		<p style="text-align: center;">Straight ahead</p> <p>Bend extended arms at elbows and move wands up and down from chest height to head</p>
5(a).		<p style="text-align: center;">Turn left (from pilot's point of view)</p> <p>With right arm and wand extended at a 90-degree angle to body, make "come ahead" signal with left hand. The rate of signal motion indicates to pilot the rate of aircraft turn</p>
5(b).		<p style="text-align: center;">Turn right (from pilot's point of view)</p> <p>With left arm and wand extended at a 90-degree angle to body, make "come ahead" signal with right hand. The rate of signal motion indicates to pilot the rate of aircraft turn</p>

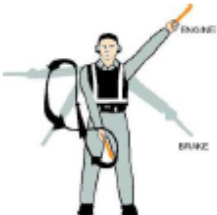

6(a).		<p style="text-align: center;">Normal stop</p> <p>Extend arms and wands fully at a 90-degree angle to sides and slowly move to above head until wands cross</p>
6(b).		<p style="text-align: center;">Emergency stop</p> <p>Extend arms and wands abruptly to top of head, crossing wands</p>
7(a).		<p style="text-align: center;">Set brakes</p> <p>Raise hand just above shoulder height with open palm. Ensuring eye contact with flight crew, close hand into a fist</p> <p>Do not move until receipt of “thumbs up” acknowledgement from flight crew</p>
7(b).		<p style="text-align: center;">Release brakes</p> <p>Raise hand just above shoulder height with hand closed in a fist. Ensuring eye contact with flight crew, open palm</p> <p>Do not move until receipt of “thumbs up” acknowledgement from flight crew</p>
8(a).		<p style="text-align: center;">Chocks inserted</p> <p>With arms and wands fully extended above head, move wands inward in a “jabbing” motion until wands touch</p> <p>Ensure acknowledgement is received from flight crew</p>

8(b).		<p style="text-align: center;">Chocks removed</p> <p>With arms and wands fully extended above head, move wands outward in a “jabbing” motion</p> <p>Do not remove chocks until authorised by flight crew</p>
9.		<p style="text-align: center;">Start engine(s)</p> <p>Raise right arm to head level with wand pointing up and start a circular motion with hand; at the same time, with left arm raised above head level, point to engine to be started</p>
10.		<p style="text-align: center;">Cut engines</p> <p>Extend arm with wand forward of body at shoulder level; move hand and wand to top of left shoulder and draw wand to top of right shoulder in a slicing motion across throat</p>
11.		<p style="text-align: center;">Slow down</p> <p>Move extended arms downwards in a “patting” gesture, moving wands up and down from waist to knees</p>
12.		<p style="text-align: center;">Slow down engine(s) on indicated side</p> <p>With arms down and wands toward ground, wave right or left wand up and down indicating engine(s) on left or right side, respectively, should be slowed down</p>

13.		<p style="text-align: center;">Move back</p> <p>With arms in front of body at waist height, rotate arms in a forward motion. To stop rearward movement, use signal 6 (a) or 6 (b)</p>
14(a).		<p style="text-align: center;">Turns while backing (for tail to starboard)</p> <p>Point left arm with wand down and bring right arm from overhead vertical position to horizontal forward position, repeating right arm movement</p>
14(b).		<p style="text-align: center;">Turns while backing (for tail to port)</p> <p>Point right arm with wand down and bring left arm from overhead vertical position to horizontal forward position, repeating left arm movement</p>
15.		<p style="text-align: center;">Affirmative/all clear</p> <p>Raise right arm to head level with wand pointing up or display hand with “thumbs up”; left arm remains at side by knee</p> <p>Note – This signal is also used as a technical/servicing communication signal</p>
16*.		<p style="text-align: center;">Hover</p> <p>Extend arms and wands fully at a 90-degree angle to sides</p>

17*.		<p style="text-align: center;">Move upwards</p> <p>Extend arms and wands fully at a 90-degree angle to sides and, with palms turned up, move hands upwards. Speed of movement indicates rate of ascent</p>
18.		<p style="text-align: center;">Move downwards</p> <p>Extend arms and wands fully at a 90-degree angle to sides and, with palms turned down, move hands downwards. Speed of movement indicates rate of descent</p>
19(a)*.		<p style="text-align: center;">Move horizontally left (from pilot's point of view)</p> <p>Extend arm horizontally at a 90-degree angle to right side of body. Move other arm in same direction in a sweeping motion</p>
19(b)*.		<p style="text-align: center;">Move horizontally right (from pilot's point of view)</p> <p>Extend arm horizontally at a 90-degree angle to left side of body. Move other arm in same direction in a sweeping motion</p>
20*.		<p style="text-align: center;">Land</p> <p>Cross arms with wands downwards and in front of body</p>
21.		<p style="text-align: center;">Fire</p> <p>Move right hand wand in a "fanning" motion from shoulder to knee, while at the same time pointing with left-hand wand to area of fire</p>

22.		<p style="text-align: center;">Hold position/stand by</p> <p>Extend arms and wands fully downwards at a 45-degree angle to sides. Hold position until aircraft is clear for next manoeuvre</p>
23.		<p style="text-align: center;">Dispatch aircraft</p> <p>Perform a standard salute with right hand and/or wand to dispatch the aircraft. Maintain eye contact with flight crew until aircraft has begun to taxi</p>
24.		<p style="text-align: center;">Do not touch controls (technical/servicing communication signal)</p> <p>Extend right arm fully above head and close fist or hold wand in horizontal position; left arm remains at side by knee</p>
25.		<p style="text-align: center;">Connect ground power (technical/servicing communication signal)</p> <p>Hold arms fully extended above head; open left hand horizontally and move finger tips of right hand into and touch open palm of left hand, forming a "T". At night, illuminated wands may also be used to form the "T" above head</p>
26.		<p style="text-align: center;">Disconnect power (technical/servicing communication signal)</p> <p>Hold arms fully extended above head with finger tips of right hand touching open horizontal palm of left hand, forming a "T"; then move right hand away from the left</p> <p>Do not disconnect power until authorised by flight crew. At night, illuminated wands may also be used to form the "T" above head</p>

27.		<p>Negative (technical/servicing communication signal)</p> <p>Hold right arm straight out at 90 degrees from shoulder and point wand down to ground or display hand with “thumbs down”; left hand remains at side by knee</p>
28.		<p>Establish communication via interphone (technical/servicing communication signal)</p> <p>Extend both arms at 90 degrees from body and move hands to cup both ears</p>
29.		<p>Open/close stairs (technical/servicing communication signal)</p> <p>With right arm at side and left arm raised above head at a 45-degree angle, move right arm in a sweeping motion towards top of left shoulder</p>

5.2. From the pilot of an aircraft to a signalman

Note 1 – These signals are designed for use by a pilot in the cockpit with hands plainly visible to the signalman, and illuminated as necessary to facilitate observation by the signalman.

Note 2 – The aircraft engines are numbered in relation to the signalman facing the aircraft, from right to left (i.e. No. 1 engine being the port outer engine).

5.2.1. Brakes

Note – The moment the fist is clenched or the fingers are extended, indicates, respectively, the moment of brake engagement or release.

(1) Brakes engaged – raise arm and hand, with fingers extended, horizontally in front of face, then clench fist.

(2) Brakes released – raise arm, with fist clenched, horizontally in front of face, then extend fingers.

5.2.2. Ready to start engine(s)

Raise the appropriate number of fingers on one hand indicating the number of the engine to be started.

5.2.3. Chocks

(1) Insert chocks – arms extended, palms outwards, move hands inwards to cross in front of face.

(2) Remove chocks – hands crossed in front of face, palms outwards, move arms outwards.

5.3. Technical/servicing communication signals

5.3.1. Manual signals shall only be used when verbal communication is not possible with respect to technical/servicing communication signals.

5.3.2. Signalmen shall ensure that an acknowledgement is received from flight crew with respect to technical/servicing communication signals.

Note – The technical/servicing communication signals are specified in First Schedule to standardise the use of hand signals used to communicate to flight crews during the aircraft movement process that relate to servicing or handling functions.

(2) From a pilot of an aircraft to a marshaller

The signals specified in the first column of the hereunder table, given by a pilot in an aircraft, shall have the meaning specified in the second column of the table.

Description of signal		Meaning of signal
(1)	Raise arm and hand with fingers extended horizontally in front of face, then clench fist	Brakes engaged
(2)	Raise arm with fist clenched horizontally in front of face, and then extend fingers	Brakes released
(3)	Arms extended palms facing outwards, move hands inwards to cross in front of face	Insert chocks
(4)	Hands crossed in front of face, palms facing outwards, move arms outwards	Remove chocks
(5)	Raise the number of fingers on one hand indicating the number of the engine to be started. For this purpose, the aircraft engines shall be numbered in relation to the marshaller facing the aircraft, from his right to his left, for example, no. 1 engine shall be the port outer engine, no. 2 engine shall be the port inner engine, no. 3 engine shall be the starboard inner engine, and no. 4 engine shall be the starboard outer engine.	Ready to start engines

PART VIII – AIR TRAFFIC CONTROL

Provision of air traffic control services

(1) At every aerodrome, other than a Government aerodrome, which is provided with means of two-way radio communication with aircraft and is situated in a control zone or is an aerodrome in respect of which the Authority has given a direction to the owner or person in charge of the aerodrome requiring air traffic control service to be provided there, the owner or person in charge of the aerodrome shall cause air traffic control service to be provided, at all times, when the aerodrome is open for the take-off and landing of aircraft.

(2) At every aerodrome, other than a Government aerodrome, which is provided with means of two-way radio communication with aircraft and with equipment for providing holding aid, let down aid or approach aid by radio or radar, the person in charge of the aerodrome shall inform the Authority in advance of any period during which any of the equipment will be in operation for the purpose of providing holding aid, let down aid or approach aid and, without prejudice to subparagraph (1), cause air traffic control service to be provided, at all times, when the equipment is notified as being in operation for any of those purposes.

AIR TRAFFIC CONTROLLERS RATINGS

1. (1) Subject to subparagraph (2), the holder of a licence which includes ratings of 2 or more of the classes specified in paragraph 2 shall not, at any one time, perform the functions specified in respect of more than one of those ratings.

(2) The functions of any one of the following groups of ratings may be exercised, at the same time –

- (a) the aerodrome control rating and the approach control rating;
- (b) the approach control rating and the approach radar control rating, except that the functions of the approach control rating shall not be exercised at the same time as the functions of the approach radar control rating if the service being provided under the latter is a surveillance radar approach terminating at a point less than 2 nautical miles from the point of intersection of the glide path with the runway.

2. Rating of the following classes may be included in an air traffic controller's licence, other than a student air traffic controller's licence, and subject to this paragraph and of the terms and conditions of the licence, the inclusion of a rating in a licence shall entitle the holder to exercise the privileges specified, respectively, as follows –

- (a) an Aerodrome Control Rating shall entitle the holder of the licence, at any aerodrome for which the rating is valid, to provide air traffic control service, otherwise than with a type of radar equipment for which a radar control rating is required under this paragraph, for any aircraft on the manoeuvring area or apron of that aerodrome or which is flying in the vicinity of the aerodrome traffic zone by visual reference to the surface;
 - (b) an Approach Control Rating shall entitle the holder of the licence, at any aerodrome for which the rating is valid, to provide air traffic control service, otherwise than with any type of radar equipment for which a radar control rating is required under this paragraph, for any aircraft which is flying in the vicinity of the aerodrome traffic zone, whether or not it is flying by visual reference to the surface;
 - (c) an Approach Radar Control Rating shall entitle the holder of the licence, at any aerodrome for which the rating is valid, to provide air traffic control service with the aid of any type of surveillance radar equipment for which the rating is valid for any aircraft which is flying within 40 nautical miles of the aerodrome traffic zone whether or not it is flying by visual reference to the surface;
 - (d) a Precision Approach Radar Control Rating shall entitle the holder of the licence, at any aerodrome for which the rating is valid, to provide air traffic control service with the aid of any type of precision approach radar equipment for which the rating is valid;
 - (e) an Area Control Rating shall entitle the holder of the licence at any place for which the rating is valid, to provide air traffic control service with the aid of any type of surveillance radar equipment for which the rating is valid.
-